



---

**SCIENCE FIRST PEOPLES**  
TEACHER RESOURCE GUIDE

---

SECONDARY

## **Secondary Science First Peoples Teacher Resource Guide**

Copyright © 2019, First Nations Education Steering Committee  
and First Nations Schools Association

### **Copyright Notice**

No part of the content of this document may be reproduced in any form or by any means, including electronic storage, reproduction, execution, or transmission without the prior written permission of FNEC.

This project has been funded in part by the British Columbia Ministry of Education.

### **Acknowledgements**

#### Development Team

Kenneth Campbell, Half Moon Communications  
Jo-Anne L. Chrona, Curriculum Manager, FNEC  
Jeremy Janz, SD 52, Prince Rupert  
Desiree Marshall-Peer, University of British Columbia-Okanagan  
Leona Prince, SD 91, Nechako Lakes  
Bill Romswinkel, SD 36, Surrey  
Darrell Schaan, Connected Classroom Instructor, FNEC  
Ellen Simmons, Nicola Valley Institute of Technology  
Anne Tenning, SD 83, North Okanagan-Shuswap

#### Contributors

Mati Bernabei, SD 41, Burnaby  
Tannis Calder, SD 52 Prince Rupert  
Stephanie Sedgwick, SD 91, Nechako Lakes



**fnesc**



**FNSA**

### **Contact Information**

First Nations Education Steering Committee and First Nations Schools Association  
#113 - 100 Park Royal South West Vancouver, BC V7T 1A2  
604-925-6087 / 1-877-422-3672 info@fnesc.ca

# Secondary Science First Peoples Teacher Resource Guide

<b>Introduction</b> .....	3
About This Resource Guide.....	4
First Peoples Pedagogy.....	5
Perspectives on Science.....	7
Using the Secondary Science Teacher Resource Guide.....	9
<b>Part One: Foundations</b> .....	11
1. Indigenous Knowledge, Indigenous Science .....	12
2. Involving Local First Nations Communities .....	17
3. Connecting With the Land: Including Land-Based Activities in Your Units .....	21
4. Finding and Using Narratives in the Science Classroom .....	24
5. Encouraging First Nations Learners' Engagement in Science .....	26
6. Suggestions for Developing Locally Based Resources .....	27
7. Assessment Suggestions .....	32
<b>Part Two: Thematic Units</b>	
1. Exploring Indigenous Science Perspectives .....	35
2. Transformation, Genetics and Evolution .....	55
3. Relationships to Fresh Water .....	85
4. Shaping the Land .....	115
5. Place-Based Ethnobotany Inquiry.....	135
6. Salmon and Interconnectedness.....	159
7. Connecting Food Security and Climate Change.....	179
8. Forests and First Peoples.....	211
9. Hunting and Trapping.....	231
10. Living Technologies.....	251
<b>Part Three</b>	
Bibliography.....	273

# Introduction

## 1. About This Guide

With the increased inclusion of First Peoples' content and perspectives in the BC curriculum, there is a need to incorporate unappropriated First People's perspectives into Science courses. Previously, the First Nations Education Steering Committee and the First Nations Schools Association developed teacher resources to support courses in Science for Grades 5 to 9, English Language Arts, Social Studies, and Mathematics. This guide expands these resource materials to include Senior Secondary Science courses.

The Secondary Science First Peoples Teacher Resource Guide is designed to assist science teachers in all BC schools, including First Nations, public and independent school.

The guide includes background information regarding how First Peoples' knowledge and perspectives in science can be recognized and included in science inquiry. It also offers curriculum planning suggestions, and provides examples of fully developed units that correspond with the Big Ideas and Learning Standards in the BC Provincial Science Curriculum for grades 10 to 12.

This guide is intended in part to address the Calls to Action of the Truth and Reconciliation Commission, particularly the call to “integrate Indigenous knowledge and teaching methods into classrooms” (clause 62) and “build student capacity for intercultural understanding, empathy and mutual respect” (clause 63).

### *Goals of the Secondary Science First Peoples Teacher Resource Guide*

- to contribute to Reconciliation for all by building greater understanding of the skills, knowledge and perspectives of First Peoples for all students
- to provide resources to enable teachers to incorporate First Peoples' perspectives into the teaching and learning of the sciences
- to ensure the inclusion of First Peoples' perspectives is done respectfully and without appropriating First Peoples' knowledge
- to implement strategies to enhance Indigenous students' participation in the sciences
- to encourage and support the respectful development of local resources
- to reflect the connection with the land on which we are all situated

## INTRODUCTION

### First Peoples Principles of Learning

Learning ultimately supports the well-being of the self, the family, the community, the land, the spirits, and the ancestors.

Learning is holistic, reflexive, reflective, experiential, and relational (focused on connectedness, on reciprocal relationships, and a sense of place).

Learning involves recognizing the consequences of one's actions.

Learning involves generational roles and responsibilities.

Learning recognizes the role of Indigenous knowledge.

Learning is embedded in memory, history, and story.

Learning involves patience and time.

Learning requires exploration of one's identity.

Learning involves recognizing that some knowledge is sacred and only shared with permission and/or in certain situations.

## 2. First Peoples Pedagogy

These learning resources are guided by the recognition of ways of learning inherent in First Nations' world views. While each First Nation has its own unique identity, values and practices, there are commonly held understandings of how we interact and learn about the world. In respect of these, the activities in this guide:

- are learner centred
- are inquiry-based
- are based on experiential learning
- emphasize an awareness of self and others in equal measure
- recognize the value of group processes
- support a variety of learning styles

The activities are based on the above principles which reflect a respectful and holistic approach to teaching and learning and are an example of Indigenous Knowledge. The First Peoples Principles of Learning were first articulated by a diverse team of Indigenous educators, scholars and knowledge-keepers during the development of English 12 First Peoples.

## INTRODUCTION

### *What Is Important to Understand About Using This Guide*

The guide is intended to help facilitate the respectful and meaningful inclusion of Indigenous knowledge and perspectives into the BC classrooms. As such, it often reflects an approach to Indigenous knowledge that values a holistic, integrated approach to teaching and learning.

As a part of a holistic approach, this guide does not attempt to create units for sole applicability to one course or a single grade, and does not attempt to match individual lessons with specific learning outcomes.

Teachers will need to explore and examine all parts of the guide to determine what to use that makes the most sense given the contexts of who the students are, where the learning is taking place, the course and grade level, and the background knowledge or comfort levels of the teacher.

It is acknowledged that exploration of the thematic units to determine the best units and activities to use for specific courses, grades, and student contexts may require thoughtful consideration and time of a teacher, but it is also more consistent with an Indigenous approach to learning.

It is expected that the additional time required to explore the guide will result in an increase of background knowledge and understanding for educators, and is an opportunity for teachers to collaborate with educators of other courses and grades.

While this guide is focussed on a specific curricular area of learning, teachers are encouraged to make explicit links to other curricular areas.

This guide also does not replace what educators are expected to already know about effective assessment practices. As such, the guide does not endeavour to include these in detail. While some formative assessment opportunities are suggested, educators may need to use their own expertise to more fully develop these. As well, they will need to develop their own summative assessments to match the activities that they use.

# INTRODUCTION

## 3. Perspectives of Science

All science begins with an innate curiosity about the world. Humans strive to understand the natural world by observing, testing and hypothesizing. But being human, we interpret what we discover in diverse ways, for multiple purposes. Based in the worldviews and traditions of different cultures, unique perspectives on what is important to know about science have developed.

In thinking about the context of bringing First Peoples perspectives into the science class, we can consider three different approaches to science:

- Indigenous Science is the knowledge of Indigenous peoples, including scientific and evidence-based knowledge, which has been built up over thousands of years of interaction with the environment. It is holistic and relational knowledge rooted in place and contained in language.
- Western Science is an evidence-based way of understanding the natural world. Asking questions and discovering answers results in a continuous revision of knowledge. The application of science has often been in discrete or compartmentalized specialities.
- School Science encompasses both what is considered important to teach and learn in K-12 schools, and how science is taught. Ideally, it incorporates scientific curiosity and inquiry.

### Convergence

Indigenous Science and Western Science are complementary ways of knowing about the world, and today they have in many ways converged in modern scientific practice. However, some school science has been left behind by not being part of the convergence.

There are many examples of Western science discovering what has already been known by Indigenous peoples. For example, recent DNA studies show a direct genetic link between Ts'msyen people living at Metlakatla BC today with bones recovered from a nearby archaeological dig that are 5500 years old. Underwater archaeology on Haida Gwaii has found evidence that people lived there more than 12,000 years ago.

Western science is moving towards a more holistic vision of nature, in accordance with Indigenous thought. For example, in July 2012, The Cambridge Declaration of Consciousness was made by leading neuroscientists who declared that animal and human consciousness are on the same level. This and other discoveries substantiate the interconnectedness of all things.

In another example, UBC forestry scientist Dr. Susanne Simard discovered that trees communicate with each other in the forest through sophisticated fungal networks. She

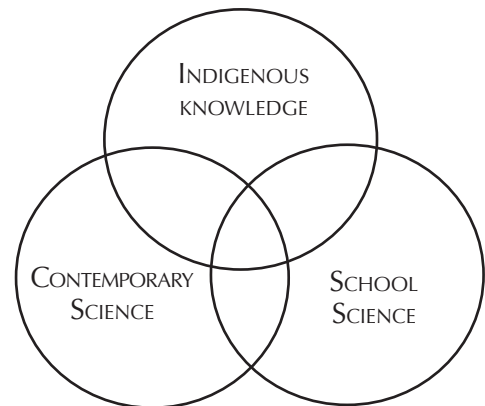

## INTRODUCTION

also helped identify Mother Trees, large trees which act as hubs for a vast network of young trees and seedlings.

In environmental science, Traditional Ecological Knowledge is very important for scientists developing baseline data. Where scientific data about the behaviour of a certain species may only go back thirty years when scientific recording began, traditional knowledge can take it back generations. As well, it is a crucial indicator of how well resource management strategies are working, as Indigenous people observe changes in their local ecosystems.

Some scientists are understanding story and narrative as an important way of communicating the findings from their labs to a public which is increasingly bombarded with information that may be true or false. See, for example, the article “And, But, Therefore: Randy Olson and the Art of Science Storytelling” (Huffington Post 2016, <https://bit.ly/2OJaQWj>).

Integrating Traditional Knowledge and Western science is seen as vitally important in working to achieve sustainability in our use of resources and bringing balance back to our ecosystems that have been impacted by modern society.

School science, on the other hand, has sometimes been seen as prescriptive, based solely on facts to be learned. In some cases, it projects the view that what is important in the world has already been discovered. The knowledge that is transmitted is most often based in Western worldviews.

Today more educators are bringing school science into convergence with Indigenous Knowledge and Western Science through a broader understanding of what Indigenous Knowledge is and how it can be infused into the classroom.

When we braid Indigenous Science with Western Science we acknowledge that both ways of knowing are legitimate forms of knowledge. For Indigenous peoples, Indigenous Knowledge (Indigenous Science) is a gift. It cannot be simply bought and sold. Certain obligations are attached. The more something is shared, the greater becomes its value.<sup>1</sup>

---

1. Gloria Snively and Wanosts’a7 Lorna Williams, Braiding Indigenous Science with Western Science, Book 1, page 4.



## INTRODUCTION

### 4. Using the Secondary Science Teacher Resource Guide

The materials in the Teacher Resource Guide are meant to be a beginning or starting place for educators. They are not comprehensive, and hold only a minute sample of BC First Peoples' scientific knowledge. There are diverse First Nations communities in BC speaking over thirty languages, living in myriad different ecosystems from the desert of the Okanagan to rainforests of the coast. Each has its own unique body of knowledge special to its local territories.

The guide is made of up three parts:

- **Foundations** which offer key information to support and guide teachers in incorporating First Peoples science into the curriculum
- **Thematic Science Units** which provide a variety of student activities that integrate with the BC Science Learning Standards
- **Bibliography**: an annotated list of resources for students and teachers.

The Thematic Science Units can and should be used in conjunction with locally developed resources. A richer curriculum results when you connect with your local community, as there is significant diversity of cultures and languages between communities, and there is much knowledge that is locally held.

The units in this Teacher Resource Guide provide a variety of learning activities and resources for teachers to adapt to their own lesson planning. The activities are intended to be flexible in their use. Although the first activity is usually an introduction to the topic, the activities are not necessarily meant to be taken sequentially. It is not expected that a teacher would use all the suggested activities.

The units are designed to be embedded in the BC Science curriculum, but they also offer many opportunities for cross-curricular planning.

The units are organized as follows:

- **Overview**: An overview of the goals of the unit and options for teachers to plan their lessons
- **Guiding Questions**: These guiding questions embody the core concepts, issues, problems or theories that are at the root of the activities. They ensure that Indigenous perspectives are at the centre of the activities.
- **Learning Standards**: A table indicates relevant Content Learning Standards and Curricular Competencies for the senior secondary science courses that the unit is most applicable to.
- **Resources**: Essential and useful resources are listed. They include:
  - Suggested Resources (required for the main activities)
  - Additional Suggested Resources
  - Blackline Masters

## INTRODUCTION

- **Suggested Activities:** The activities have been developed with a flow or sequence, but are intended to be flexible and adaptable. Generally they begin with introductory activities which in many cases ground the topic in the personal and local. Later activities build on knowledge and skills learned in earlier activities

### Assessment

- **Formative Assessment Strategies:** The activities include some suggestions for formative assessment, noted in the margins beside the relevant activity.
- **Summative Assessments:** It is expected that teachers will adapt the suggested activities to create their own units, and will thus develop their own summative activities depending on the activities their students undertake.

# Part One: Foundations

What is Indigenous Science, and how can it become a significant component of senior secondary classes?

This section provides some background information and insights into ways of bringing First Peoples' knowledge and perspectives on science into the classroom, and ensuring a reciprocal relationship with local First Nations communities when planning student activities.

This section includes:

1. Indigenous Knowledge, Indigenous Science
2. Involving Local First Nations Communities
3. Connecting With the Land: Including Land-Based Activities in Your Units
4. Finding and Using Narratives in the Science Classroom
5. Encouraging First Nations Learners' Engagement in Science
6. Suggestions for Developing Locally Based Resources
7. Assessment Suggestions

Resonance is the key term in this whole perspective [of Indigenous Knowledge]. The idea and the understanding that the focus of Native Science was really not to try to explain away the mystery of the natural world but was about finding ways to resonate with the natural world and the natural order towards the effect of sustainability and also of the meaning of life as a whole.

Dr. Gregory Cajete

## PART ONE: FOUNDATIONS

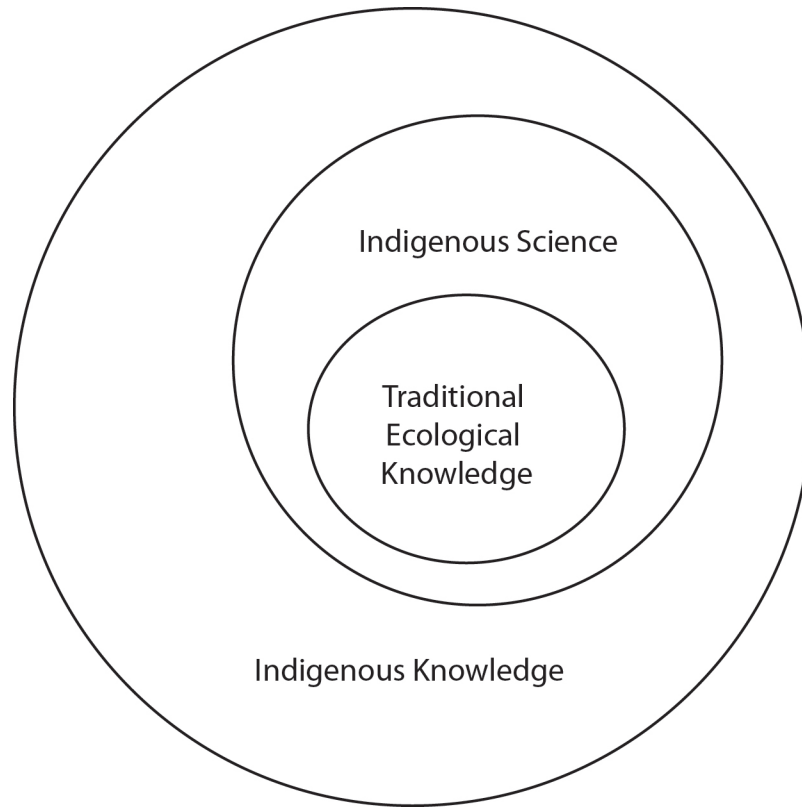

### 1. Indigenous Knowledge, Indigenous Science

Indigenous Science makes up a significant part of the greater body of knowledge often called Indigenous Knowledge, which is the sum of cultural knowledge and wisdom held by Indigenous peoples of the world. It contains all that can be encompassed by a unique worldview, such as values and beliefs, creative expression, history, political and economic systems, and human relationships as well as science. While it is rooted in historical knowledge, it is also dynamic and growing.

 For more about bringing Indigenous Science to the classroom, see *Knowing Home: Braiding Indigenous Science with Western Science, Books 1 and 2*, Gloria Snively and Wanosts'a7 Lorna Williams, eds. <https://tinyurl.com/fnesc83>  
<https://tinyurl.com/fnesc76>

Some characteristics of Indigenous Knowledge include:

- Knowledge that is locally-based. First Peoples have occupied their traditional territories for millennia and their knowledge reflects an intimate connection with their lands.
- Diversity. Because it is based locally, Indigenous Knowledge has developed in a multitude of ways.
- Shared principles. Despite the diversity between individual groups of First Peoples, most share common underlying principles, such as a worldview based on interconnectedness and reciprocal relationships with the natural world.

A portion of this knowledge can be classified as Indigenous Science. This is a body of evidence-based local knowledge and skills acquired over thousands of years.

## PART ONE: FOUNDATIONS

### *Traditional Ecological Knowledge*

Traditional Ecological Knowledge, or TEK, is the most popular term to denote the vast local knowledge First Peoples have about the natural world found in their traditional environment.

Some people consider the term misleading because “Traditional” suggests that the knowledge is stuck in the past, where in fact it is dynamic and continually being renewed. As well, the use of “Ecological” can be seen as limiting, for the knowledge referred to is holistic and goes beyond the discipline of ecology, and embraces many topics such as spirituality, astronomy, medicine and technology. However, “ecological” in its broader usage can refer to the idea that TEK is rooted in the local landscape.

One way of understanding TEK is to consider it not as just a database of collected information, but as a *process* of participating in relationships, as explained in this quote:

Native understandings of TEK tend to focus on relationships between knowledge, people and all of creation (the “natural” world as well as the spiritual). TEK is viewed as the process of participating (a verb) fully and responsibly in such relationships, rather than specifically as the knowledge gained from such experiences. For First Peoples, TEK is not just about understanding relationships, it is the relationship with Creation.<sup>1</sup>

TEK is, above all, local knowledge based in people’s relationship to place. It is also holistic, not subject to the segmentation of Western science. Knowledge about a specific plant may include understanding its life cycle, its spiritual connections, its relationship to the seasons and with other plants and animals in its ecosystem, as well as its uses and its stories.

TEK is widely used in biological and environmental sciences, and is largely considered to be complimentary to, and equivalent with, Western scientific knowledge. The environmental knowledge of generations is important to fields such as resource management, climate change and sustainability. For example, at the federal level, a TEK subcommittee reports to the Committee on the Status of Endangered Wildlife in Canada which make recommendations to the Minister based on TEK in their own local regions on species that may need to be listed.

It is important to recognize that TEK is the intellectual property of the First Nations who hold it. Many people share much of their knowledge with others, but some knowledge and wisdom, due to cultural protocols, is considered private and is not shared.

---

<sup>1</sup> Deborah McGregor, Linking Traditional Ecological Knowledge and Western Science: Aboriginal Perspectives from the 2000 State of the Lakes Conference. *Canadian Journal of Native Studies* XXVIII, 1(2008):139-158. Page 145.

## PART ONE: FOUNDATIONS

### Language and Story

Language is the vessel that contains Indigenous knowledge. Understanding is embedded in language, and knowledge is structured and transmitted through language. Learning through oral language is part of its experiential nature.

Indigenous languages are rich and precise, expressing the specific knowledge required to understand the local ecosystem.

Through the processes of colonization, First Nations languages have undergone attack. Most communities suffered significant language loss, and one of the results of the loss of language is the loss of knowledge. As well, learning has moved from the oral to the written.

Some languages face extinction, but others are experiencing renewal. People are working to revitalize languages which in turn will serve to keep traditional knowledge alive.

Like most languages, strong Indigenous languages continue to grow and sometimes new words are added for contemporary objects. For example, in Sm'algayax, the Ts'msyen language, the word flashlight is *laawksm ts'amti* (light lightning or lightning from a light). In Tsilhqot'in, the word for helicopter is *betsit'ay naghedalt'ex* (Something that has something spinning on top of it.)

Incorporating traditional languages into experiential science activities wherever possible is an important part of bringing Indigenous Science into the classroom. Using appropriate language in non-trivial ways helps to validate Indigenous students and the knowledge of First Peoples communities. It also helps other students experience and understand a diversity of world views.

Where possible, develop a word bank of words and phrases from the local First Nations languages that are relevant to the units and subjects you teach, and incorporate them into lessons and assessments. There may be local community language resources in the school or community to support this.

### Story

Story is one of the main methods of traditional Indigenous learning and teaching. Combining story and experience is a powerful strategy that has always been used by First Peoples, and its power can also be brought to the science classroom.

Stories enable holistic learning. They meld values, concepts, protocol, practices and facts into a narrative. They also develop important skills of listening and thinking.

Story can be an important part of the science curriculum. Oral storytelling can be incorporated by inviting First Nations storytellers into the class, or the teacher can read a written version of a traditional story where appropriate. Reading published stories that are relevant to the science class can integrate with English Language Arts, or with First Nations language classes.

 **First Voices** is a useful online source for BC First Nations languages. It gives students searchable vocabularies in many of BC's diverse First Nations languages [www.firstvoices.com](http://www.firstvoices.com)

 **Foundations** For suggestions on how to find and incorporate story into your science units, see the section Finding and Using Narratives in the Science Classroom, page 24.

## PART ONE: FOUNDATIONS

### Place Names

Traditional place names provide information about First Peoples and their relationship with the land. Traditional knowledge is often embedded in place names. Paying attention to the name of places in traditional territories can lead to a wealth of information about local ecosystems, land use or plant and animal behaviour.

Many First Nations communities have documented the traditional place names of their traditional territories and they may be available as a classroom resource. However, some place names may be considered private and to be used only by community members.

### *Shared Concepts of Indigenous Knowledge*

As mentioned, despite the incredible diversity of the locally-based knowledge held by First Peoples, there are some important concepts that are key to understanding Indigenous Knowledge.

#### ❖ Reciprocal Relationships

An essential value of Indigenous worldview is the understanding of reciprocal relationships in all interactions in life, including those with the natural world. In such relationships, there are mutual benefits to both parties. From a First Peoples perspective, it means giving back to the land when we receive from it. It is like an exchange of gifts.

This relationship is often expressed symbolically. It is the mind-set with which a person approaches the relationship; the feeling or intent of gratitude that is key from the human perspective. Usually First Peoples thank the plants or animals that give themselves to nourish the humans as they harvest them. Sometimes, people leave a gift such as tobacco or another item as a token of respect and thanks.

By emphasizing the importance of reciprocity, First Peoples ensure that the natural world is kept in balance and maintained in a sustainable way.

#### ❖ Interconnectedness

First Peoples are diverse, and the unique knowledge each group holds is part of their individual worldview. However, they share a common belief that we are all connected to nature and to each other. This notion that we are all connected with everything in the world is expressed by many First Peoples in the phrase “All my relations.”

Inherent in this view of the world is the understanding that everything in the universe has a place there and deserves respect. From this vantage point, people view their relations with others as well as the natural world differently than someone who sees it through a microscope or telescope.

## PART ONE: FOUNDATIONS

### ❖ Transformation and Renewal

The natural world works in patterns and cycles. These processes mean that change is essential; everything from quarks to weather systems to solar systems are in constant motion. Change brings about transformation.

In transformational processes, things move through different states and dimensions, whether it is energy, carbon atoms, thought or spirit.

Transformation is at the centre of many First Peoples' traditional narratives and origin stories. They include characters called Transformers and Tricksters who assist human in ways that included transformation. Those stories are often placed in times when animals and people were able to transform shape. For example, many narratives tell of humans or other beings that have been transformed into physical features of local landscapes.

The cyclical nature of transformation results in renewal, like the seasons, the returning salmon, or the camas blooming. Renewal is necessary for life to be sustained. This implies that people need to behave in sustainable ways to ensure renewal.

First Peoples recognize the significance of renewal through communal events and ceremonies. Many communities mark the beginning of the return of important resources such as the First Salmon, First Fruits and First Bitterroot ceremonies.

### ❖ Sense of Place

Connection with place, with the land, is the foundation of Indigenous Knowledge.

This means that each Indigenous group holds unique world views, technologies and pedagogies according to their environment and territories. Indigenous knowledge, passed on through the generations, was essential for sustaining life. Survival for First Peoples depended on and depends on their particular knowledge of the land, their unique relationship with the environment, and their shared values and practices through which they made sense of the world.

The concept of Place goes far beyond the physical space. It includes a crucial Sense of Place, the memories, emotions, histories, spiritualities that bind the people to the land.

Five concepts of place have been identified, common to most First Peoples:

- Place is multidimensional. More than the geographical space, it also holds cultural, emotional and spiritual spaces which cannot be divided into parts.
- Place is a relationship. All life is interrelated.
- Place is experiential. Experiences a person has on the land give it meaning.
- Place is local. While there are commonalities, each First Nation has a unique, local understanding of Place.
- Place is land-based. Land is interconnected and essential to all aspects of culture.

Making connections with place in science curricula is an integral part of bringing Indigenous science into the classroom. That means including experiential learning in local natural and cultural situations.



#### Foundations

For ideas to build a sense of place and include land-based activities, see Including Land-Based Activities in Your Units, page 21.



## PART ONE: FOUNDATIONS

### 2. Involving Local First Nations Communities

Many of the activities in these units suggest working with an Elder or other Knowledge-keepers from a local First Nations community. These suggestions are the ideal, but of course it will not be feasible to invite speakers in every instance.

Also, it is important to remember that not every Elder or knowledge-keeper holds knowledge about every cultural topic. In most Indigenous societies, certain knowledge is held by specialists who are trained to use and pass on the knowledge. People often have specific roles and responsibilities within the community. As well, people have different life experiences to draw on.

#### *Making Connections with the Community*

Bringing First Peoples perspectives of science into the classroom means in part connecting with the local First Nations community. It is important to understand, respect and practice the local protocols when:

- inviting Elders and other knowledgeable community members into the classroom to speak
- interacting with the natural world when going out on field trips
- visiting First Nations lands and territories
- interviewing people
- holding special events such as a celebratory feast
- developing science units

Most communities have protocols in place to be followed when working with Elders and knowledge-keepers. This may include showing respect by offering a gift to the person, or perhaps to the land when on a field trip.

Make contact with the local First Nations communities through workers in schools or through the local Band Council. There may be a School District staff member such as an Aboriginal District Principal, Aboriginal Helping Teacher, Resource worker or other liaison person to help with the initial contact. Guidance can be sought from local learning centres and community organizations such as Friendship Centres, First Nations offices, Tribal Councils or cultural centres.

It is important to work with the appropriate agencies to make sure that certain Elders and knowledge-keepers do not get over-worked or called upon too often.

All knowledge shared by local First Nations is inherently their intellectual property. Respect their right to keep certain knowledge private.

## PART ONE: FOUNDATIONS

### *Diverse School-Community Relationships*

How you make connections with the local community and develop locally-based activities may depend on where your school is located:

#### **First Nations Community**

For schools in a First Nations community, students will likely focus on the knowledge and resources in their community. Students may have direct experience with the land of the territories of their people. They may have family members who are involved in the traditional resource gathering practices. The First Nations language may be taught in the school.

#### **Public Schools that serve one or more First Nations communities**

For public schools which serve one or more First Nations communities, there likely is a relationship built up between the school and community. They likely have a large number of students from one or more local communities, with established liaisons between school and community. The First Nations language may be taught in the school.

#### **Schools with a significant population of Indigenous students from diverse communities**

For town or city schools which have a significant number of Indigenous students from diverse communities, build on the strengths of the knowledge of the students in the class, where appropriate. (Don't necessarily expect Indigenous students to want to or be able to speak about Indigenous knowledge related to their home communities.)

#### **Schools with few Indigenous Students**

Even though your school may have few or no First Nations students, it is still important to incorporate Indigenous content. For schools with few First Nations students, build an understanding of the traditional territories on which the school is located. Identify ways to establish connections with other schools with significant numbers of First Nations students and First Nations communities. In their studies students could undertake comparative studies of First Nations practices in different parts of the province.

## PART ONE: FOUNDATIONS

### *First Peoples Guest Speaker Considerations*

It is important to follow protocols when inviting a member of a First Nations community or Aboriginal organization to a classroom or school. Below are some general considerations and processes. There are also often protocols specific to local communities. School district Aboriginal education departments or community education departments can also provide guidance regarding those specific protocols.

These considerations can also be adapted when taking students on field trips or into field learning experiences that will be led by, or facilitated by, a member of a First Nations community or Aboriginal organization.

#### **Before the Visit**

- Determine the purpose of the visit (how it is connected to the curriculum or learning standards for the class or course). If it is not directly connected to the curriculum, be clear about the intended learning standards so that the guest visit is meaningful experience for all involved.
- It is a culturally appropriate protocol for guest speakers to be provided with a gift and/or honourarium for sharing their time and knowledge.
  - Consult with the school district's Aboriginal education department or First Nations community to determine the appropriate amount or gift (if the speaker has not already indicated an amount for an honourarium).
  - Determine where funds will come from in advance. Check to see if the school or PAC can contribute.
  - If the school and/or school district requires any paperwork to be completed before payment can be issued, ensure that this is done well in advance of the visit so that payment can be issued at the time of visit or as soon as possible afterward.
- Talk with the speaker about the details of the visit:
  - Date and time of the visit
  - The course and grade levels of the students
  - Approximate number of students
  - Let the speaker know what content/learning has led up to the visit.
- Ask the speaker about any specific needs:
  - Are there any hand-outs that need to be photocopied in advance, or any equipment or supplies needed?
  - Is there any specific information that students should know before the visit?
  - Are there any specific protocols that the students and adults need to follow during the visit?
  - Is there anything else that will help make the visit more comfortable for the speaker (especially if it is an Elder)?
  - Would it help to have the classroom/space organized in a specific way?
  - Ask for permission to take photos or videotape (if desired).
- Ask the speaker for some background information that can be used to introduce the speaker to the students (for example, where the speaker is from, his or her role or occupation, noteworthy experiences or accomplishments).

## PART ONE: FOUNDATIONS

- Arrange arrival details:
  - Ensure everyone knows where the speaker will be met. For example, arrange to have the speaker met in the parking lot, at the front door of the school, or in the main office.
  - In some situations, the speaker may need transportation from home.
  - If possible, include students in the greeting.
- Ensure the students are prepared prior to the visit:
  - Connect speaker's visit to students' previous learning
  - Review respectful behaviour with students, including non-verbal communication
  - Model for students how to introduce themselves
  - Brainstorm with students questions that they can ask
  - Prepare students to provide a thank-you to speaker
- Ensure office staff and administrators know that a guest is expected.

### Day of Visit

- Prepare physical space of classroom. Set up any necessary equipment.
- Welcome guest, offering water/tea/coffee. Let them know where washrooms are located.
- Introduce speaker to students and if appropriate do acknowledgment of territory.
- If students will be introducing themselves to the speaker, consider a talking circle format, saying name and where they are from.
  - Ensure there is time for questions/discussion at the end of the session.
  - Have student(s) formally thank the speaker and present gift or honourarium.
  - If possible, debrief the session with speaker.
  - Walk the guest out.

\*It is important that the teacher stay present for the session as this models for the students a valuing of the knowledge and time of the speaker. If any behavioural challenges occur, it is the teacher's responsibility to address them, not the speaker's.

### After the Visit

- Debrief the session with the students.
- Do follow-up activity with students.
- Have students follow up with thank-you letter.
- Touch base with speaker to ensure that honourarium was received (if not presented on day of session).

## PART ONE: FOUNDATIONS

### 3. Connecting With the Land: Including Land-Based Activities in Your Units

Understanding and experiencing connections with the land is fundamental to Indigenous Knowledge. One way of integrating Indigenous ways of knowing into a science unit is to provide students with an opportunity to interact with the land in some way. Ideally, every unit will include a land-based activity. This section gives some suggestions for how that can be achieved.

Activities that provide experiences and connections with the land are not intended to imitate or recreate actual First People's relationships with their territories. (The exception, of course, is for students in a First Nations community school whose experiences will be related to their own cultural activities).

The types of land-based activities suggested here are intended to encourage students to:

- develop their own relationships with the land
- interact with their environment and community
- engage in authentic experiences
- develop an understanding and appreciation of different relationships with the land
- view the land from a holistic, interconnected perspective

#### Suggestions for incorporating land-based activities into your units

- Know your local area. Beyond the school grounds, what places in your neighbourhood can students visit? Explore what options are available for land based activities, such as parks, open areas, or woodlands.
- Include a holistic view; consider the big picture as well as the specific activity.
- Some possible types of land-based activities include:
  - food and medicine gathering with appropriate guidance from the local First Nations community
  - geological field trips
  - visits to archeological sites
  - exploring the night sky from an Indigenous perspective.
- You may be able to collaborate with other teachers to make joint trips.
- Have discussions with your administration to offer opportunities within the schedule.
- Adapt some of the walks suggested in *A Walking Curriculum: Evoking Wonder and Developing Sense of Place* by Gillian Judson.
- For more background and ideas, see the article "Learning from the Homeland; An Emerging Process for Indigenizing Education," by the W?SÁNEC School Board and Tye Swallow. It is found in *Knowing Home: Braiding Indigenous Science with Western Science, Book 2*, page 206. Download from <https://tinyurl.com/fnesc76>.

## PART ONE: FOUNDATIONS

### Planning for Land-Based Activities

Taking students out on the land requires planning both by students and teachers.

#### a. Selecting a Site

- Select a suitable site that students can safely and easily visit. A natural site will likely enable students to have a feeling of being connected with the land or nature. However, any site, such as a nearby park or a corner of the school grounds should have some type of character that students can identify and reflect on.
- Carry out necessary field trip permission and parental notification, as required

#### b. Preparing for the site visit

- Prepare students for the visit to the site by explaining the purpose of the activity. This will depend on how you are using these activities: on their own, or as part of a larger project.
- Go over expectations for behaviour and safety considerations, and any other protocols that may pertain to the field trip.

#### c. For more ideas for planning outdoor activities, see:

- *Get Outdoors! : An Educator's Guide to Outdoor Classrooms in Parks, Schoolgrounds and Other Special Places* (Sue Staniforth, WildBC) It includes Teacher Tip Sheets such as Outdoor Classroom Essentials, Field Trip Checklist and Outdoor Field Trip Planner.
- Judson, Gillian. *A Walking Curriculum: Evoking Wonder and Developing Sense of Place*.

### Land-Based Learning in Action

Here are two examples of authentic land-based projects experienced by students in cooperation with their local First Nations community.

#### Connecting Natural Resources and Economic Activities Kitasoo Community School, Klemtu

The high school class of Kitasoo Community School in Klemtu, BC, partnered with the local members of the KXIRA (Kitasoo-Xaixais Integrated Resource Authority), to participate in a land-based activity in which students visited different locations in their territory with the primary purpose of studying the connections between natural resources and economic activities in the area.

Local knowledge keepers shared stories with the students about the historical, environmental and socio-cultural significance of these places to the local First Nations. They also explained the different designations for places within the territory (reserve, conservancy, provincial park) and what each means as far as how the area was managed in the past and is managed today.

Once students returned to the classroom they evaluated the different perspectives people can have surrounding the use of natural resources in their territory and participated in a role play activity where they had to negotiate

## PART ONE: FOUNDATIONS

between different stake holders who were interested in the potential economic opportunities in the area.

As an assessment piece, students returned to the locations in the territory and were given the opportunity to share what they had learned about each location to the KXIRA members. Students shared their knowledge of the history, socio-cultural significance, and the different natural resources of each site.

The assessment piece for this project aimed to honour the oral transmission of knowledge in First People's cultures and the notion that knowledge is often focused on a sense of place.

### Lu Lax Kyook Ecological Monitoring Project Hartley Bay School, SD 52

Students from Hartley Bay School, of the Gitga'at First Nation, participated in real-life ecological monitoring of a local estuary over the 2014-2015 school year. They worked with Elders and scientists, and were supported by the community and the Band Council. Not only did they create their own learning, the students contributed real data to the community's on-going monitoring programs, and were able to help build a better capacity to plan for future generations. The project won the Jack Layton Award for Youth Action in Sustainability presented by Learning for a Sustainable Future for 2015. (See <http://lsf-1st.ca> for more information.)

View an overview of the project in this video: <http://bit.ly/2dqgVBc>

The goal was to provide an immersive learning environment where no one subject area was distinct from the other. The students themselves, with the guidance and direction of teachers, developed their own big ideas and constructed their own knowledge. They threw out the textbook and made our Place the textbook.

To conduct their surveys in the Mossy Bay estuary, students travelled by boats. The equipment and scientific instruments were in most cases supplied by the Gitga'at Guardians but the students were involved in making some instruments. Students participated in monitoring five particular elements of the Lu lax kyook estuary:

1. Fish populations in the estuary (Beach Seining)
2. Salinity and Temperature
3. Stream Flow
4. Land Animals surveying (Trail Cameras)
5. Berries

Students used traditional techniques such as locating animal trails, and modern technology including automatic trail cameras. This created an excellent blend of the modern with the traditional. Additionally, students learned in multiple subject areas through one learning project: Language Arts (Sm'algyax/English), Socials, Science, Math, PE, Media Visual Arts and Visual Arts.

## PART ONE: FOUNDATIONS

### 4. Finding and Using Narratives in the Science Classroom

Using traditional narratives in science units is a way of connecting with Indigenous knowledge and acknowledges the First Peoples Principal of Learning: “Learning is embedded in memory, history, and story.”

#### What to look for in finding narratives in science classes.

- The story should be authentic. It will be approved by an Indigenous group or body, either published directly by them or with an indication that the story or publication has their approval.
- While there may not be a narrative that relates to specific curriculum content, you may be able to find a local story that speaks to a holistic approach to the content.

#### Narrative sources

- Ideally, a local First Nations storyteller would visit your class to share a narrative that relates to your unit. Work with your school and district’s Aboriginal Education staff to help you to find a storyteller. They may also be able to help you communicate with the storyteller the theme of the unit and the type of story that will fit with the topic of your unit.
- There are video sources of First Nations storytellers sharing stories on the internet. These can be relied on to be authentic. However, beware of videos that illustrate or act out a traditional story unless you are sure that it is authentic and produced by or with Indigenous artists.
- Children’s books
- Published sources

#### Things to know about narratives

- Traditional narratives that are printed may have different structures than students may be used to. Many Indigenous narratives are complex intertwined stories that can take hours or days to tell fully. Often when an Elder has shared a story that has later been printed, it is just one part of a much longer narrative.
- The stories are out of context. As traditional stories were told many times, people would have known the cultural references and the context of a character or an event, so the narrative we read today often lacks this context.

#### What can students look for in a traditional narrative?

- Often examples of Traditional Ecological Knowledge are embedded in a story. Sometimes they may be explicit, other times they may be implied.
- What lessons does the story teach about human’s relationship with the land?
- How is an Indigenous perspective or worldview embedded in the story?



## PART ONE: FOUNDATIONS

### Sources for Narratives

Here are a few sources to find First Nations stories and narratives. More references can be found in the Bibliography, page 273.

- *People of the Land: Legends of the Four Host First Nations*. Theytus Books. 2009. Lil'wat, Musqueam, Squamish, and Tsleil-Waututh narratives. (See summaries of the stories in the Bibliography, page 275.)
- Sinixt Nation. Chaptikwl (Stories)  
<http://sinixtnation.org/content/chaptikwl-stories>
  - Coyote meets the Wind and the Sinixt
  - How the Columbia River Came to Be
  - Mountain Goat Brings Huckleberries
  - Frog Mountain Story (ancient survival story of Sinixt) includes video
  - Coyote at Kettle Falls
- Man Turned to Stone: T'xwelátse. Stó:lō Nation. Man Turned to Stone website. Stó:lō Research and Resource Management Centre. Link at <https://tinyurl.com/fnesc90>

This website describes the traditional story of the man who was transformed to stone, as well as a background to the importance of stories and the connections with the land.
- Transformation Stories. See Unit 2, Activity 2.1

### 5. Encouraging First Nations Learners' Engagement in Science

It is important to remember that there is as much diversity between First Nations learners as there is among all learners in BC. What works for one learner may not work for all learners. However, there are some general strategies that can encourage more First Nations learners' interest and participation in the sciences.

- Emphasize experiential hands-on learning opportunities outside the classroom.
- Make room for students to explore aspects of science that they are interested in, and that are based in the learner's own curiosity.
- Provide opportunities for students to work with, and learn from, Indigenous role models who work in the sciences, or Indigenous post-secondary students in the sciences.
- Ensure that the learning in the classroom can be connected to the learner's knowledge outside the classroom.
- Honour that there is valuable knowledge in the sciences that is held by First Peoples (i.e. Indigenous Knowledge).
- When in the classroom, ensure rich lab-work opportunities.
- Focus on the application of knowledge.
- Ensure visible presence of Indigenous peoples/cultures in the classroom.
- Incorporate project-based learning that is connected to traditional First Nations seasonal practices (i.e. food-gathering or harvesting, hunting).
- Honour cultural knowledge of the students, and help them make "bridges" between different types of knowing.
- Model respect for Indigenous peoples and cultures.
- Create opportunities for students to engage in science clubs outside of the classroom. Hooking learners into the application of science may lead them to develop more interest in the theory.

In "Metaphorical Images of Sciences: The Perceptions and Experiences of Indigenous Students who are Successful in Senior Secondary Science," Anne Tenning interviewed Indigenous students who were high achievers in their secondary science classes. The following excerpts illustrate their perspectives about what encouraged them to pursue a science path.

- "I like how there's so many experiments you can do and it's challenging, but in the end, you feel like you gave your best and you feel happy that you found the answer to what you were doing. It gives you a sense of pride or something."
- "Inclusion of Indigenous Knowledge in science education would give all students a wider perspective about science."
- Indigenous Knowledge in science "would be a good way to learn things, especially for Aboriginal students – they'd get more into it, instead of thinking, 'oh, this is boring' and they'd maybe want to explore more sciences if they were learning about their own people." [A student] explained that Western Science is "contradictory to what you're

## PART ONE: FOUNDATIONS

taught at home, so it's just reinforcing that 'living in two worlds' kind of thing.”

- Participants reinforced the importance of teaching to a variety of different student-learning styles.
- Students need to be given ample opportunities to explore topics that are of interest to them.
- Students are more likely to develop a deeper interest in science if it is an interactive, hands-on, creative experience, rather than a passive experience which places a primary emphasis on rote methods of acquiring knowledge, including lectures, notes and memorization. Such methods of instruction are in stark contrast with traditional Indigenous ways of learning (which includes, but is not limited to, learning situated in a natural environment, experiential learning, and collaborative learning) and this may further alienate Aboriginal students who bring with them a strong sense of cultural connection.
- Indigenous Knowledge should be included at every level of science education. Indigenous content should be included in all science courses, particularly at the senior-secondary level, which are formative years for students as they transition into adulthood.

See Anne Tenning, “Metaphorical Images of Sciences: The Perceptions and Experiences of Indigenous Students who are Successful in Senior Secondary Science” in *Knowing Home: Braiding Indigenous Science with Western Science, Book 2*, page 34.

<https://tinyurl.com/fnesc76>

## 6. Suggestions for Developing Locally Based Resources

This guide gives sample units which incorporate Indigenous Science perspectives into science activities. Teachers are encouraged to develop local units that speak to the local sense of place and non-appropriated knowledge of local First Nations, in collaboration with knowledgeable community members.

### Framework for Designing Indigenous Science Resources

On the following pages is a rubric for designing locally-based Indigenous science resources. It was developed by, and reprinted with the permission of Dr. Judy Thompson. Some fundamental aspects for involving Indigenous science include:

- Indigenous Voice. What cultural experts can contribute to the unit implementation?
- Indigenous Languages. How can the local First Nations languages be included in the lessons?
- Diversity of Indigenous Groups. Do the lessons recognize the diversity of First Nations? Can the unit be shared and adapted to other groups?
- Protocol. What protocols need to be followed during the implementation of the unit?
- Relationship with the Land. How can the unit reinforce the importance of the land, plants and animals to Indigenous people?
- Ways of Learning, Ways of Teaching. Are traditional ways of learning included? Are activities student centered? Is evaluation formative?

# Framework for Designing Indigenous Science Resources

## PART ONE: FOUNDATIONS

<i>Criteria</i>	<i>Gradations of Quality</i>			
	<i>4</i>	<i>3</i>	<i>2</i>	<i>1</i>
<i>Indigenous Voice</i>	Cultural experts are a significant and critical part of unit implementation. Elders and community members are involved at all stages of the curriculum development process and an Indigenous person is directly involved in the writing of the curriculum.	Cultural experts are involved. Elders and community members have been involved in many stages of the curriculum development process.	Cultural experts have been involved, but their role is not clear.	Involvement of cultural experts not mentioned.
<i>Indigenous Languages</i>	Indigenous languages are recognized as being an integral part of Indigenous ways of knowing and worldview. The language plays a large part in the lessons and activities.	Indigenous languages are recognized as being an integral part of Indigenous ways of knowing and worldview. While the language does not play a large part in the lessons, the importance of learning the language from Elders and other fluent speakers is stressed.	No mention of the importance of Indigenous languages to Indigenous ways of knowing and worldview but there are Indigenous words used here and there throughout the curriculum.	Indigenous languages are not part of the curriculum and there is no mention of their importance to Indigenous ways of knowing and worldview.
<i>Diversity amongst Indigenous Peoples</i>	Focus of curriculum is on one particular Indigenous group. The curriculum is flexible enough so that it can be adapted to other Indigenous groups.	Focus of curriculum is on one particular Indigenous group. There is not much flexibility in the lessons so that they cannot be adapted to other Indigenous groups.	Curriculum is very general and is not focused on any particular Indigenous group. However, it does make reference to the diversity amongst Indigenous groups.	Curriculum is very general and is not focused on any particular Indigenous group. Does not make reference to the diversity amongst Indigenous groups.

Adapted from: Appendix F, pp. 136-140. Thompson, J.C. (Edösdí), (2004). *Gitga'at Plant Project: The Intergenerational Transmission of Traditional Plant Knowledge Using School Science Curricula*. (Unpublished Master's Thesis). University of Victoria, Victoria, BC.

PART ONE: FOUNDATIONS

<p><b>Protocol</b></p>	<p>It is recognized that when working with specific Indigenous communities and cultural experts that there are protocols to be followed. These are explicitly stated.</p>	<p>It is recognized that when working with specific Indigenous communities and cultural experts that there are protocols to be followed. These are not stated, but are directed to individuals and/or organizations (e.g. hereditary chiefs, band council members, educators, etc.) in order to find out the proper protocol to be followed.</p>	<p>The importance of following protocol is not highlighted, but individuals and/or organizations within the community are listed as contacts for general information.</p>	<p>There is no mention of the importance of following protocol.</p>
<p><b>Relationship with the Land</b></p>	<p>States the importance of the land, plants and animals to Indigenous peoples. Lessons either take place out of the classroom on the land (e.g. at fish camps, seaweed camps, etc.) or in the classroom. Cultural experts are integral to the lessons.</p>	<p>States the importance of the land, plants and animals to Indigenous peoples. While some lessons take place out of the classroom on the land, many of the lessons take place in the classroom. Cultural experts are often involved.</p>	<p>Does not state the importance of the land, plants and animals to Indigenous peoples. Most of the lessons take place in the classroom but cultural experts are brought in once in a while.</p>	<p>Does not state the importance of the land, plants and animals to Indigenous peoples. Lessons take place inside a classroom without the involvement of cultural experts.</p>
<p><b>Ways of learning, ways of teaching</b></p>	<p>Traditional ways of learning and teaching are outlined. Activities are numerous and varied and are student-centred. They often take place on the land with Elders (observation, practice, participation, active involvement, etc.). Learning and evaluation ideally take place at the same time; is formative.</p>	<p>Traditional ways of learning and teaching are mentioned. Several activities take place, such as videos, guest speakers, field trips, guided labs, non-directed labs. Lectures are limited and teacher acts as a facilitator. Evaluation is a balance of formative and summative.</p>	<p>Traditional ways of learning and teaching are not mentioned. Some activities, such as videos or guided labs. Evaluation is a balance of formative and summative.</p>	<p>Traditional ways of learning and teaching are not mentioned. Activities are teacher-centred (lecture oriented). Evaluation is summative.</p>

## Working in Partnership with Community Members

Great success comes from working in collaboration with the local community. Here are some fundamental considerations when consulting with community members.

- Develop classroom resources in collaboration with Elders, knowledge keepers and other community members.
- Approach the community members with respect.
- Prepare to consult with community members by reading published or online resources relating to your topic to get an idea of local knowledge.
- Explore ways to allow students to get out onto the land and to experience the “place” of the local First Peoples.
- Remember that not all knowledge can be, or will be, shared. This needs to be respected.
- All cultural knowledge remains the copyright of the community. Educators, schools and/or school districts should not attempt to copyright lessons developed in collaboration with First Nations communities.
- How you connect with the local First Nations community will depend on your school and location.
  - Most school districts have a District Aboriginal Principal or similar position who may be able to connect you with community members.
  - Band operated schools have an education coordinator or other band council member whose responsibility is liaison with the schools.



## 7E Model

The 5E model has been widely used as a structure for developing experiential learning activities for science. This model can be expanded to include two significant components that incorporate Indigenous science: Environment and Elders. It can be used to structure a single lesson, or a unit over a number of days. It works well as an organizer for inquiry learning.

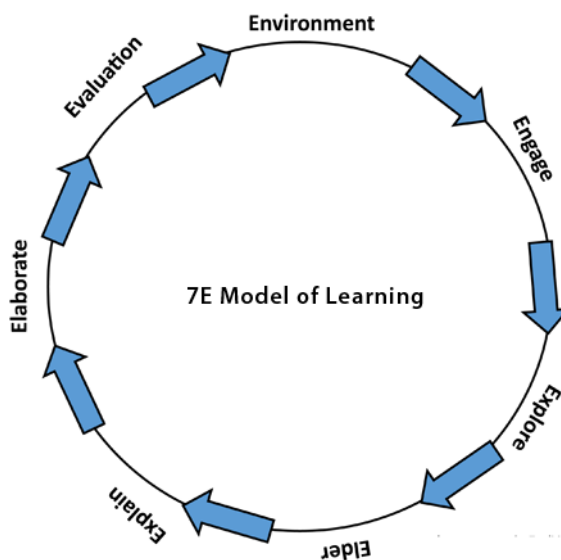

### Environment

Situate the lessons in the local land and environment. This builds an appreciation for the concept that everything is connected to everything else and taps into a sense of Place.

### Engage

Capture student attention and curiosity. Raise scientifically relevant questions. Connect what students know with a new question or idea. Ask a question, show something interesting, pose a problem.

### Explore

Experiential. Students observe, record, connect ideas, and ask questions, usually in groups. Teachers are coaches and facilitators.

### Elder

Elders and other knowledgeable community members represent the Indigenous Knowledge held by the community. They can connect the science activities through sharing their traditional knowledge. Where Elders or other knowledge keepers are not available, students may consult other authentic and appropriate cultural resources such as video, print and online sources.

### Explain

Describe observations and come up with explanations. Develop vocabulary, apply and interpret evidence. Students reflect on their processes, thinking and conclusions. Teachers guide students with questions and suggest additional resources.

### Elaborate

Use information to extend learning to new situations. Make connections to their personal lives and to society. Teachers help students broaden understanding.

### Evaluation

Students demonstrate their understanding of concepts and skills learned. Teachers ask open-ended questions and encourage students to self-assess their learning.

## 7. Assessment Suggestions

While summative assessment has a needed place and purposes, teachers are especially encouraged to use a variety of formative assessment strategies, in keeping with the First Peoples Principles of Learning and inquiry models.

### Formative Assessment Strategies

Formative assessment is assessment for learning by providing ongoing and timely feedback to students, and at the same time allowing teachers to tailor instruction to the needs of students or groups. It is embedded in regular instruction and inquiry.

A variety of formative assessment strategies can also help document students learning, and be part of their ongoing portfolio of student work.

#### 1. Informal Questioning

By asking timely and thought-provoking questions, teachers can informally assess students' understandings of concepts and processes and also guide their learning.

- Questions can focus students' reflection on the concepts, skills, goals and processes involved in an activity, providing teachers with information about their learning before, during, and after an activity or step in an inquiry.
- Most questioning, being timely, will be undocumented, but checklists could be used to assess certain concepts, skills or processes.

#### 2. Performance Task

Performance tasks are used both to teach and assess. They may consist of a single task or a set of tasks.

- Students communicate their understanding of skills and concepts through a variety of modes: active demonstration, text, images, or models. If used for formative assessment purposes, these task could provide opportunities for self and peer assessment along with teacher feedback (as opposed to being used to generate a score or grade).

#### 3. Graphic organizers

Students can represent their learning in a visual way using a variety of graphic organizers. Examples of graphic organizers include:

- Concept Map
- Compare/Contrast
- KWL
- Venn Diagram
- Classifying Chart
- Cause and Effect
- T-Chart
- Story Board
- Sequencing Chart
- Topic/Subtopic Web



#### 4. Rubrics or other criteria referenced tools.

- Depending on the activity, teachers, students or both together can develop criteria to be assessed. They can be used for assessing understandings of concepts, project or reports, self-assessment or peer-assessment.
- Performance checklist

#### 5. Journals and Portfolios

- Provide students with relevant topics or cues for their reflective journaling.
- Assess informally during the course of classwork.
- Have students assess their journals and portfolios at the end of the unit. Ask them to identify 5 or 10 sections that seem to be the most important for their learning.

#### 6. Projects and Presentations

- Self and peer assessment can be used. Students can help set out the criteria for assessment.

### Question Suggestions for Formative Assessments Using the 7Es

#### Environment

- What is special about the place we live? (in the context of the topic under study)
- How might place help you to think about the topic we're going to explore?
- What do you wonder about the place where we live?

#### Engage

- What do you already know, and what would you like to know about the topic, issue or idea? (KWL strategy could be used)
- Ask students questions that will help you to assess the level of students' understanding.
- Ask students questions that can lead to clearing up misconceptions in students' background knowledge.

#### Explore

- What is the big idea you want to explore?
- What questions do you have about this big idea?
- What one or two inquiry questions will you focus on?
- How will you go about investigating your question?

#### Elders

- How did working with Elders, cultural experts or other cultural sources add to your understanding of your question?
- Did you find out any relevant words or phrases from the local First Nations language?
- Ask questions that allow students to explain the processes they followed in their inquiry.
- Ask questions that enable students to connect their explanations with scientific knowledge and Traditional Ecological Knowledge.

#### Elaborate

- Help students develop new questions.
- Ask questions that guide students to apply their learning in new ways.

#### Evaluation

- Ask students questions that provide opportunities to show that they understand the key concepts studied.
- Ask questions that enable students demonstrate their learning progress.

### Recommended Resources for Assessment

Conley, David T. "Toward Systems of Assessments for Deeper Learning." In *Rethinking Readiness: Deeper Learning for College, Work, and Life*. Harvard Education Press, 2017. Available online at <https://tinyurl.com/fnesc957>

Frey, Nancy, John Hattie, Douglas Fisher. *Developing Assessment-Capable Visible Learners, Grades K-12. Maximizing Skill, Will, and Thrill*. Corwin, 2018.

Rosenthal Tolisano, Silvia and Janet A. Hale. *Guide to Documenting Learning: Making Thinking Visible, Meaningful, Shareable, and Amplified*. Corwin, 2018.

# Unit 1

## Exploring Indigenous Science Perspectives

### Overview

This unit brings together activities related to Traditional Ecological Knowledge and Shared Concepts of Indigenous Knowledge that are discussed in Part One, Foundations.

The activities help to scaffold the concepts of Indigenous Knowledge and Indigenous Science. They may be used together for a unit that explores Indigenous perspectives, or they could be individually incorporated into one of the thematic units, or a unit you have developed.

### *Guiding Questions*

- How can Indigenous Science help us understand our relationship with and responsibilities to the Earth?
- In what ways can Indigenous Knowledge and Science contribute to the Earth's sustainability and the preservation of diversity?
- How can Indigenous Science and Western Science work together?

## UNIT 1 • EXPLORING INDIGENOUS SCIENCE PERSPECTIVES

### Relevant BC Learning Standards for Senior Secondary Science

This unit does not deal with Content Standards directly, but does relate to the Curricular Competencies.

The Key Curricular Competencies for Secondary Science courses include:

<b>Questioning and predicting</b> <ul style="list-style-type: none"><li>• Make observation aimed at identifying their own questions, including increasingly abstract ones, about the natural world.</li><li>• Formulate multiple hypotheses and predict multiple outcomes</li></ul>
<b>Planning and conducting</b> <ul style="list-style-type: none"><li>• Assess risks and address ethical, cultural, and/or environmental issues associated with their proposed methods and those of others</li></ul>
<b>Processing and analyzing data and information</b> <ul style="list-style-type: none"><li>• Experience and interpret the local environment;</li><li>• Apply First Peoples perspectives and knowledge, other ways of knowing and local knowledge as sources of information</li></ul>
<b>Evaluating</b> <ul style="list-style-type: none"><li>• Demonstrate an awareness of assumptions, question information given, and identify bias in their own work and secondary sources</li><li>• Consider social, ethical, and environmental implications of the findings from their own and others' investigations</li><li>• Critically analyze the validity of information in secondary sources and evaluate the approaches used to solve problems</li></ul>
<b>Applying and innovating</b> <ul style="list-style-type: none"><li>• Transfer and apply learning to new situations</li><li>• Contribute to finding solutions to problems at a local and/or global level through inquiry</li></ul>
<b>Communicating</b> <ul style="list-style-type: none"><li>• Express and reflect on a variety of experiences, perspectives, and worldviews thorough place.</li></ul>

### Resources

For further information on these resources, see the annotations in the Bibliography, beginning on page [273](#).

### Suggested Resources

Print

- Judson, Gillian. *A Walking Curriculum: Evoking Wonder and Developing Sense of Place* (K-12). 2018. 68 pages.
- *People of the Land: Legends of the Four Host First Nations*. Theytus Books, 2009.
- *River of Salmon Peoples*. Theytus Books, 2015
- White, Ellen Rice. *Legends and Teachings of Xeel's, the Creator*. Theytus Books, 2018.

## UNIT 1 • EXPLORING INDIGENOUS SCIENCE PERSPECTIVES

### Video

- *Indigenous Connections to the Land*. 4:37 min. Dr. Alannah Young Leon and Francine Burning, 2015. [https://youtu.be/vxJB\\_c9JqHc](https://youtu.be/vxJB_c9JqHc)
- *Two Sciences*. Native Counselling Services of Alberta. 7:51 min. NCSA Video Channel, 2015. Online at <https://youtu.be/hDMcLi9IIqY>
- *Two-eyed Seeing*, Cheryl Bartlett 2012, 8:44 min. [https://youtu.be/\\_CY-iGduw5c](https://youtu.be/_CY-iGduw5c).

### Website

- *First Voices*. First Nations Language Resource. <https://www.firstvoices.com/>
- Ignas, Veronica. *Two Ways of Knowing, Traditional Ecological Knowledge Meets Western Science*. 2003. <http://www.ecoknow.ca/curriculum.html>.

### Additional Resources

- *Earth's Systems Interact*. <http://bit.ly/2dxPXyw>
- Four Spheres Part 1 (Geo and Bio) and Four Spheres Part 2 (Hydro and Atmo) <http://bit.ly/2ddXDql> and <http://bit.ly/2dq47kW>.
- Great Bear Sea, Environmental Science 11 & 12. [www.greatbearsea.net](http://www.greatbearsea.net)
- Two-Eyed Seeing, [www.integrativescience.ca](http://www.integrativescience.ca), <https://tinyurl.com/fnesc47>

### Blackline Masters

- 1-1 Indigenous Science
- 1-2 What is Traditional Ecological Knowledge?
- 1-3 Traditional Knowledge About Plants
- 1-4 Responsibilities to the Land
- 1-5 Thinking About Transformation

### Outline of Activities

- 1.1 What is Traditional Ecological Knowledge?
- 1.2 Reciprocal Relationships with the Land
- 1.3 Circles of Life: Transformation and Renewal
- 1.4 Interconnectedness
- 1.5 Sense of Place
- 1.6 Two Ways of Seeing the World

## Suggested Activities

Note: There are more activities here than most teachers will incorporate into their units. It is not expected that you will use all of the activities, or follow the sequence as it is described. These activities are intended to be adapted to fit the needs of your students and classroom, as well as inspire ways that you can respectfully include relevant Indigenous knowledge and perspectives in your course.

 Blackline Master  
1-1, page 49,  
*Indigenous Science*

### What is Indigenous Science?

Blackline Master 1-1, page 49, *Indigenous Science*, can be used in a variety of ways. It could be enlarged and made into an anchor chart, or copies made for each student to keep as a reference.

## Activity 1.1

### What Is Traditional Ecological Knowledge?

 **Foundations**  
For more about  
Traditional Ecological  
Knowledge, see page  
13.

If students are not familiar with the term Traditional Ecological Knowledge or TEK, you can use these activities to introduce the concept. It can also be used as review.

Traditional Ecological Knowledge is simply stated, but it encompasses many different, and at times, complex strands. These activities will help to establish a basic understanding of the concept.

- a. Begin by asking the students the question, “What does a person need to know to survive in the modern world?”
  - Leave the question open to interpretation, and have students work in groups to answer it, then share with the whole class.
  - You may want to have students classify their responses, such as knowledge to provide basic needs, to work, to use technology, or to raise a family.
- b. Discuss the question “How would you survive if the power suddenly went off for good?”
- c. Have students think about the question, “In the past, how did First Peoples live on their territories from one generation to the next?”
  - Ask students to brainstorm what types of things the people living on the local lands would have needed to know to sustain life for thousands of years.
  - Students can explore how seasonal rounds helped First Peoples to live on their territories from one generation to the next. Find resources that illustrate the seasonal rounds of local First Nations. Some First Nations communities have calendars in which the traditional names of the months reflect the seasonal relationships with the land.
  - Develop a list of types of knowledge and wisdom people would need to know.

## UNIT 1 • EXPLORING INDIGENOUS SCIENCE PERSPECTIVES

- d. Discuss with students why living sustainably on the land was essential to their survival. Guide students to think about how First Peoples interacted with the plants and animals that live on the land, and to consider the importance of making sure the resources of the land were not depleted.
- e. If it hasn't come up yet, introduce the term Traditional Ecological Knowledge. Elicit ideas of what it might involve.
- As a starting point, you may want to use Blackline Master 1-2, page 50, *What is Traditional Ecological Knowledge?* Students could elaborate on each of the main points, working in pairs or groups.
  - Students can hunt for examples of specific types of scientific knowledge or principles that are part of the Traditional Ecological Knowledge of plants. Although First Peoples did not traditionally use the terminology used by scientists today, such as physics, chemistry and biology, the understandings and processes are still part of the traditional knowledge.
  - Students could read Blackline Master 1-3, page 51, *Traditional Knowledge About Plants* to find out some examples of Indigenous scientific knowledge.
- f. Emphasize that Traditional Ecological Knowledge is dynamic and always changing to accommodate new information or changing conditions.
- As an example of the dynamic nature of TEK, you could use a case study about pine mushrooms, which is a significant industry in parts of northern BC. Ignas, Veronica. *Two Ways of Knowing, Traditional Ecological Knowledge Meets Western Science*. 2003. <http://www.ecoknow.ca/curriculum.html>.
    - See Lesson 4, Reconceptualizing Ecological Knowledge: The Pine Mushroom in Northwestern British Columbia, pages 36-41.
- g. To explore how Traditional Knowledge can be used in collaboration with other scientific studies, you may want to use some activities found in Exploring the Great Bear Sea, Environmental Science 11 & 12 ([www.greatbearsea.net](http://www.greatbearsea.net)). See Lesson 2: Traditional Knowledge and Collaborative Research (pages 33-43).

 Blackline Master 1-2, page 50, *What is Traditional Ecological Knowledge?*

 Blackline Master 1-3, page 51, *Traditional Knowledge About Plants*

## Activity 1.2

### Reciprocal Relationships With the Land

---



**Foundations**  
For more information about Reciprocal Relationships, see page 15.

a. Respecting the Land.

Begin the unit with a First Nations story that demonstrates an understanding of the need for a reciprocal relationship with the land. Depending on the source, you could have a local First Nations storyteller recount it to the class, you could read a published version aloud, or students could read it themselves.

- If possible, find a story from the local First Nations cultural group.
- A number of stories from different First Nations tell what happens when children mistreat resources from the land, or disrespect the animals in some way. Often the children mistreat salmon.
  - One such story is found in *People of the Land: Legends of the Four Host Nations*, pages 105-112. Watsauk Siem, a Tsleil-Waututh story, tells of the great leader Watsauk, and how his teachings about caring for the salmon were disrespected. The telling of this story emphasizes relationships with the natural world: “Watsauk’s way of managing our path of life was through relationships (107).” Each year the leader welcomes the returning salmon. After some boys disrespect the salmon, the fish disappear and the people suffer. The boys apologize to the salmon and Watsauk sings a song; the salmon return.

b. Another resource to help students understand the theme of reciprocal relationships with the land is the video *Indigenous Connections to the Land*. This 4:37 min. video shows Coast Salish people and their connections with the land, including a young girl and her grandmother, and Musqueam elder Larry Grant. Available online at [https://youtu.be/vxJB\\_c9JqHc](https://youtu.be/vxJB_c9JqHc).

- Ask students to watch and listen for examples of ways that people in the video show respect for the land.
- After they view the video, ask students to write a personal response to the video. Ask questions such as,
  - How did it make you feel?
  - What was the most important idea you gained from the video?
  - What further questions do you have about the content of the video?
- Discuss with the class the key ideas in the video. Some possible ideas include:
  - First Peoples have spiritual connection to the land and waters
  - Identity is connected with the land.
  - If you don’t respect the land, you lose access to resources like salmon.
  - We took care of the land and the land took care of us.
  - First Peoples still have strong connections to the land.
  - “I am the land.”



## UNIT 1 • EXPLORING INDIGENOUS SCIENCE PERSPECTIVES

- Ask, what do you think these ideas have to do with science? (For example, they relate to the natural world studied by science, because they discuss a First Peoples perspective of understanding the natural world.)
- c. Students can use Blackline Master 1-4, page 52, *Responsibilities to the Land*, to investigate the question of why the land should be treated with respect.
- First, students can annotate three quotes that were used in the video. They can highlight key words, add their own comments and questions in the margins. If students are not familiar with annotating text, you could model the activity by annotating the first one on the board.
  - Students can then search for another quote that says something about responsibilities or respect for the land. They may use books or internet sources to find a quote. You may want to have a discussion of what the best key words would be to search successfully.
  - Students can add a statement of their own that reflects their understanding of what responsibility people have for caring for the land.
  - Students can represent one of the statements from the *Responsibilities to the Land* Blackline Master in an illustration, drawing or diagram.
- d. Ask students if they know the meaning of the word “reciprocity.” Students can suggest definitions, or they can look up the word in a dictionary. Ask students to suggest different ways the word can be used.
- Ask students to consider what a “reciprocal relationship” would be. Ask them to give examples from life.
  - Ask students to explain what a “reciprocal relationships with the land” means. You could use the Think-Pair-Share strategy to help students to develop a definition.
  - As a class, agree on a group definition of a reciprocal relationship with the land. (The key idea that should be included is that there is a benefit for both sides of the relationship; if we take something from the land, we have to give something back.)
- f. Discuss the question, “What does a reciprocal relationship with the land look like?” Ask students to suggest some ways that people in a reciprocal relationship with the land would need to act. Ask, “How have First Peoples traditionally given back to the land?” (For example, show respect for the land, care for the land, live sustainably)
- Ask students to suggest examples of reciprocal relationships with the land illustrated in the video *Indigenous Connections to the Land* or the quotations about responsibility to the land.
- f. Have students work on their own or in pairs to create a web or concept map to represent their understandings about Reciprocal Relationships with the Land. Ask questions such as, how does the idea of “gifts” connect with reciprocal relationships? How can you show the idea of reciprocity visually?

 Blackline Master  
1-4, page 52,  
*Responsibilities to the  
Land*

 **Formative  
Assessment  
Strategy**

This activity can be used to assess students understanding of reciprocal relationships.

## Activity 1.3

### Circles of Life: Transformation and Renewal

Students will consider different perspectives of the concept of transformation.



#### Foundations

For more discussion about Transformation and Renewal, see page 16.

Thinking about the concepts of transformation and renewal is a way of bridging Indigenous and Western scientific perspectives. They relate to the cyclical nature of the natural world and many aspects of human lives.

- a. Have students think about the many ways that transformation occurs in our world and our lives. Ask students to brainstorm as many examples of transformation as they can in two minutes. If they are unsure how to respond, ask them to think of examples in different spheres of life, such as home life, science, the natural world, the arts, or personal life.
  - Students can create a mind map as they brainstorm, individually, in a group on chart paper, or as a whole class on the board.
  - Discuss some of the most significant transformations in the students' lists. What makes them significant? (For example, it might be the scale of transformation that makes it significant, or the personal impact.)
  - Ask students to explain what transformation is in their own words.
- b. Transformation Walk. Take students for a walk around the neighbourhood or in a park or other location to observe Transformation in action. Ask students to look at the world through the lens of change. Ask what do you see that is changing? What has changed? What will change? Which changes are good, bad or neutral?
- c. Ask students to compare change and transformation. Ask if change and transformation are different, and if so, how?
  - Ask students if they think there is a difference between the terms “climate change” and “climate transformation?”
  - Ask students if evolution is change or transformation. Have students explain their choice.
- d. Share one or more traditional First Peoples stories that include the concept of transformation or renewal. (See Activity 1 of unit 2 for suggestions.)
- e. Work with students to find out words in the local First Nations language for concepts like change, transform or transformation. If possible, find the etymology or root of the word. For example, in the Ts'msyen language Sm'algyax, *lulook* which means transform has the root *loo*, meaning to move quickly.
  - Students can use the website FirstVoices to find words in the local or other First Nations languages. Either search on the specific First Nation or language, or use the search field on the home page to find words that appear in all the languages that are on the site.



#### Land-based Activity Transformation Walk



#### First Voices

First Nations  
Language Resource  
<https://www.firstvoices.com/>

## UNIT 1 • EXPLORING INDIGENOUS SCIENCE PERSPECTIVES

- Students can also note the names of the Transformer or Trickster characters who are central to some First Nations creation or origin narratives. For example, in Stó:lō narratives, Transformers are Xexá:ls.
- f. Have students read the quote about Transformation by Gregory Cajete on Blackline Master 1-5, page 53. Discuss how his understanding of transformation is similar or different to the concepts the class has been discussing.
- g. Have students suggest examples of transformation in science topics they have studied. Students could illustrate one of the examples of transformation in science, or perhaps express it in another form, such as a flow chart, an animation or skit.

 Blackline Master 1-5, page 53, *Thinking About Transformation*

### Activity 1.4 Interconnectedness

Provide students an opportunity to understand the concept of Interconnectedness as a central part of First Peoples' understandings of the world. Below are some suggestions for approaching this topic with your students.

- a. Find out if there is a word or phrase in the local First Nations language that expresses the idea of interconnectedness.
- For example, the Nuu-Chah-Nulth say *Hishuk ish ts'awalk* which means "everything is one." In Haida, it is *Gina 'waadluxan gud ad kwaagid*; "Everything depends on everything." In Secwepmc, *Kweseltnews* means "We are all family."
  - If you have First Nations language classes in your school, perhaps the language teacher could help students develop their own phrase in the language.
- b. Invite an Elder or knowledgeable First Nations speaker to discuss examples of interconnectedness in the local First Nations culture.
- If possible ask them to tell a story that illustrates the idea that everything is connected.
- c. Read the traditional story "The Creator and the Flea Lady from *Legends and Teachings of Xeel's, the Creator*, by Ellen Rice White. This book was prepared for secondary students and includes four stories and commentaries by Snuneymuxw Elder Kwulasulwut (Ellen White). This short story clearly illustrates many strands of the Interconnectedness of people with the universe.
- In this story the little flea lady is overwhelmed when her baby is near death. She calls to Xeel's the Creator for help. "I know you are out there somewhere. You are in the water, in the air, in the sky, in the earth." She

 **Foundations**  
For more information about Interconnectedness, see page 15.



## UNIT 1 • EXPLORING INDIGENOUS SCIENCE PERSPECTIVES

gets the help she needs, from the energies of the universe, from the sand and rocks, and from her family. They work to build an ingenious incubator, using the elements of the land and sea.

- In a commentary that follows, Ellen discusses the ideas in the story, including the ideas of our connections with the universe. “The universe is made of energy. All things, inanimate as well as animate, are imbued with it; and we are all connected by universal energy” (p 20.)
  - Discuss with students the examples of natural, social and spiritual connections the Flea Lady had. Students could illustrate the connections to demonstrate their understanding.
- e. Use other stories, narratives and personal accounts, local ones if possible, to illustrate the idea of interconnectedness.
- *River of Salmon Peoples* contains some good discussions of interconnectedness:
    - p. 22 Dakelh community, “what happens in one area of the river affects what happens upstream or downstream.”
    - p. 33 Sardis Stó:Lō, “The Fraser is the main artery of Mother Earth for us.”
    - p. 71 Musqueam, “Our traditional viewpoint is to regard the salmon as brethren with spirits of their own.
    - p. 97-99 Sardis Stó:Lō, relationship of salmon, the river and the people
    - p. 113, Musqueam, paying respect to salmon, trees when harvesting them
    - p. 116, Seabird Stó:Lō, “What we call a relational world view is where everything is interconnected and related.”
- f. Make a word wall of words related to the idea of interconnectedness, such as holistic, unified, and integrated.
- g. Introduce or review the scientific perspective on the interconnectedness of the earth’s systems or spheres: atmosphere, biosphere, geosphere (also called the lithosphere) and hydrosphere.
- Use available resource materials as a focus for discussion. One suggestion available online is a six minute video *Earth’s Systems Interact*, found at the link <http://bit.ly/2dxPXyw> or search for title keywords.
    - Videos that describe the four spheres in an engaging way (but do not talk about interconnectedness) are Four Spheres Part 1 (Geo and Bio) and Four Spheres Part 2 (Hydro and Atmo) online at Youtube. For links go to <http://bit.ly/2ddXDqI> and <http://bit.ly/2dq47kW>.
  - Sphere stations. This activity encourages students to make connections between the spheres to demonstrate how everything is dependent on everything else.
    - Around the classroom put five pieces of chart paper labelled Sun, Atmosphere, Biosphere, Geosphere, and Hydrosphere.

## UNIT 1 • EXPLORING INDIGENOUS SCIENCE PERSPECTIVES

- Divide students into five groups and provide each group with a different colour of sticky notes.
  - The groups will rotate through each of the stations. At each station they write on the sticky notes ways that the subject interacts with the other spheres.
  - Add the note to the poster.
  - At the end, the teacher or students can read aloud some of the responses.
- h. Web of life activity. You will need a ball of string and a list of organisms.
- Give each student the name of an organism. One can have the sun.
  - You may have prepared cards or have students write assigned words on a piece of paper.
  - The person holding the sun tosses the ball of string to someone else in the circle, making sure they hold onto the end of the string.
  - The person who catches the string tells one way that their organism interacts with the sun.
  - Students continue tossing the ball of string, holding onto their section of string so that it forms a web. Each person explains one way that their organism interacts with the previous organism.
  - If someone gets stuck, others can help out.
  - Eventually a tangled web will be created.
  - Discuss what would happen if one of the objects was removed from the web. Ask how this is similar to a real ecosystem.

### Activity 1.5

#### Sense of Place

---

Students engage in activities that help them identify and build their own sense of place, and understand the importance of the sense of place in an Indigenous context.

- a. Interacting with the land.
- These activities give students an opportunity to experience and develop a sense of place when they visit a local site. This could be a stand-alone activity when introducing concepts about First Peoples Science, or could be used at the beginning of a larger land-based activity.
  - When students are at the site, ask them to observe the landscape around them. Ask questions such as:
    - Use all your senses to experience the site. What do you feel about the place when you pay attention with all your senses?
    - Find one feature in the site and observe it from all four directions: north, east, south and west. Does changing direction add anything to your understanding or experience of this feature?

 **Foundations**  
For more about the Sense of Place see page 16.

## UNIT 1 • EXPLORING INDIGENOUS SCIENCE PERSPECTIVES

- What patterns can you find in the site?
  - How are the features of the site interconnected? What relationships do they have with each other? What is your relationship with the elements of the site and the site as a whole?
- b. Walking. Find ideas for taking students on theme-based walks in *A Walking Curriculum: Evoking Wonder and Developing Sense of Place* by Gillian Judson. See also the associated website linked at <https://tinyurl.com/fnesc46>.
- c. Ecotherapy: Well-being and the Land

Students learn about a recent trend called ecotherapy and compare it with Indigenous understandings and relationships with the land.

- Background. Ecotherapy, also known as nature therapy or green therapy, is a growing field of health and well-being that encourages healing by interacting with nature. In some countries doctors are writing prescriptions for people to take a walk in the park, or to engage in some other activity that gets them out into nature. In Japan, a traditional practice, Shinrin-Yoku, also known as Forest Bathing, has been part of the national health system since 1982. Participants reconnect with nature by slowly walking through the forest, using all the senses to immerse themselves in the experience. Although finding healing through connections with nature is timeless, the term ecotherapy was first used in 1996 by H.J. Clinebell. As the concept has developed in North America, many branches of ecotherapy have emerged, such as horticultural therapy, green exercise, animal assisted therapy, wilderness therapy, natural lifestyle therapy, eco-dreamwork, community ecotherapy, dealing with eco-anxiety and eco-grief. In Western science, ecotherapy is often associated with ecopsychology, the scientific study of human emotional connections with nature.
- National Healing Forest. Students may be interested to investigate a project that encourages forests or green spaces dedicated to bringing about Reconciliation and healing. The idea of healing forests across the country came about after the Truth and Reconciliation report in 2015. Some people wanted to do something to help the healing process for both Indigenous and non-Indigenous people.
  - Students can find out more about the National Healing Forest at the website <https://www.nationalhealingforests.com/>
  - Students could undertake a project to develop a proposal for a Healing Forest in your local region.
- Students could investigate a real-life example of a convergence of ecotherapy and traditional connections with the land. A young Saskatchewan woman, Michela Carriere, won first place in the Aboriginal Youth Idea Challenge for her company called Aski Holistic Adventures where she offers retreats on her father's northern Saskatchewan trapline. She calls them holistic ecotherapy retreats. "It's been a passion of mine to show

## UNIT 1 • EXPLORING INDIGENOUS SCIENCE PERSPECTIVES

people the way that I grew up,” she said. “The main part of the business is taking people out on the land and teaching them how to reconnect with nature and Cree culture as well.”

- See the article “Medicine woman-in-training excited to launch holistic eco-therapy retreat,” linked at <https://tinyurl.com/fnesc48>.
- Students can compare the goals and practices of ecotherapy with the sense of place and connections with the land experienced by Indigenous people.

### Activity 1.6. Two Ways of Seeing the World

---

Students take part in an activity that asks them to look at objects from two different perspectives, a Western scientific way of seeing, and a way of seeing more aligned to an Indigenous perspective.

- a. Preparation. In preparation for this activity, ask students to bring in a “keepsake” or something that is important to them that has a personal or family story behind it.
  - It could be a rock they found on a beach with a friend or parent. It could be a picture or a picture of a keepsake.
  - Before students present their keepsake have them submit an image of it to you.
  - Collate the images and divide the students into groups. These groups will then analyze the pictures utilizing the scientific method.
  - It is suggested that you pre-set the groups and the pictures so a student does not accidentally get their own keepsake.
- b. Have students work in their groups to analyze the pictures of the keepsakes utilizing the scientific method of observation: Shape, size, colour, potential uses, and classification.
  - It is important that students show respect for the keepsake when doing their “scientific observations.” This could be a great time to discuss the idea of respect and its importance in the Indigenous world view. For example, the commodification of property/resources vs cultural use of property/resources.
  - Groups can then present their observations to the class.
- c. Next have students present their own keepsake and the story behind it. Student can do this in a variety of way, such as video, digital presentation, song, or spoken word.
  - Discuss how understanding is created through both the scientific method and the “cultural story” method.



- d. Introduce the idea of “Two-Eyed Seeing.” This is a term developed to describe a way of using the strengths of both Indigenous knowledge and Western scientific knowledge to understand the world.
- For more about this topic, see this article from the Integrative Science website, linked at <https://tinyurl.com/fnesc47>.
  - Students could view a video about Two-Eyed Seeing. See Two-eyed Seeing, Cheryl Bartlett 2012, 8:44 min) [https://youtu.be/\\_CY-iGduw5c](https://youtu.be/_CY-iGduw5c).
  - Another video dealing with two perspectives of science is *Two Sciences*. Native Counselling Services of Alberta, 2015 7:51 min. NCSA Video Channel, 2015. Online at <https://youtu.be/hDMcLi9IIqY>. A Cree knowledge-keeper and a Western ecologist discuss the similarities between Indigenous and Western science, particularly as it relates to wetlands.
- e. Ask students to reflect on why it is important to see the natural world from more than one perspective.
- Students can create a visual representation of the idea of two-eyed seeing, of Indigenous and Western Science working together.



## **What is Indigenous Science?**

These are some of the key features of Indigenous Science

*Traditional Ecological Knowledge*

*Language and Story*

*Shared Concepts of Indigenous Knowledge*

- ❖ Reciprocal Relationships
- ❖ Interconnectedness
- ❖ Transformation and Renewal
- ❖ Sense of Place

## What is Traditional Ecological Knowledge?

*TEK is Local Knowledge*

*TEK is Cumulative Knowledge*

*TEK Understands Interconnectedness*

*TEK is Necessary for Survival*

*TEK Practices Sustainability*

*TEK is Dynamic, Always Evolving and Growing*

Traditional Ecological Knowledge understands the relationships between all aspects of the local ecosystem:

- Plants species
- Animals species
- Habitats
- Landforms
- Weather
- Seasonal changes

## Traditional Knowledge about Plants

These are some examples of scientific knowledge that First Peoples have known about plants since Time Immemorial. What other understandings can you add to the list?

### Edible roots such as camas, balsamroot

- Traditional knowledge: Slow cooking makes the roots more digestible, more nutritious and sweeter.

In the past these roots were very important food items for many First Peoples. However, they contain inulin, a type of sugar that people can't digest. Slow cooking converts the complex sugars to the more digestible fructans and fructose.

While First Peoples don't traditionally use these chemical names, they have always understood the properties of the plant. To prepare the roots for eating, they traditionally cook them very slowly in a pit for a day or more to produce a sweet nutritious food.

### Properties of different types of wood

- Traditional knowledge: Different species of trees produce wood with unique properties that can be used for different purposes..

Traditional understandings of what type of wood to use in a certain situation is an important part of Traditional Ecological Knowledge. This includes properties such as strength, durability and density. People know that western red cedar can be split cleanly along the grain, and that it can be bent and hold its shape by steaming. They know certain woods such as mountain alder are strong but flexible, so make good bows and snowshoes.

### Strong fibres from plants

- Traditional knowledge: Some plants contain strong fibres that can be used for things like fabric, nets and rope.

Some plants such as stinging nettles contain fibres that can be processed for many uses. Using the fibres requires many types of knowledge, such as when to harvest it safely, how to process the plant to extract the fibres and how to spin a strong fibre.

### Preserving berries by drying

- Traditional knowledge: Dehydration allows plants to be preserved for long periods of time.

All types of berries can be preserved by drying in the sun or wind. Traditionally berries were often cooked, mashed and spread on a mat to dry. The dried cakes had to be stored properly so they did not reabsorb water. When it was time to eat them, the berries could be eaten dried, or rehydrated.

## Responsibilities to the Land

1. Here are three quotes from First Nations leaders about our responsibilities to the land. As you read them, annotate the quotes by highlighting key words. Add comments and questions in the margins.

As long as the sun shines, the rivers are flowing and the grasses are green we will remember our sacred responsibilities to the lands as our relatives.

Chief Peguis, 1817.

Man did not weave the web of life – he is merely a strand in it. What ever he does to the web, he does to himself.

Chief Seattle, Susomich, 1854

Our responsibilities are reminders to ensure the health and well-being of the seven generations that are coming.

Oren Lyons, Ondondaga-Seneca, 2007

2. Find another quote that expresses a First Peoples perspective about our relationship with the land. Give the source of your quote.

3. What is your point of view? Add your own words that express something about our relationship with the land.

## Thinking About Transformation

Creation stories depict the lines separating humans, animals, and forces of nature as rather fluid instead of rigid. Animals transform into humans and humans transform into animals.

Biologically, the metaphor is accurate, because when we eat an animal we are “transformed” into that animal, and the animal is “transformed” into us.

When we are eaten by animals (including by the small bacteria that will eat us all eventually), we are then transformed back into cycles of nature.

In many ways, ancient Native myths preceded biological theories of evolution and transformation.

Gregory Cajete Native Science, 2000 p 40.



# Unit 2

## Transformation, Genetics and Evolution

### Overview

Transformation is a theme that is central to Indigenous knowledge. It recognizes the dynamic, fluid and creative forces at play in the natural world. Evidence of the significance of transformation can be found in the origin or creation stories of most First Peoples. These usually tell of an ancient time when people and animals could communicate and transform shape. In some stories, beings often called Transformers or Tricksters in English transformed the earth into an environment where people could live. In reciprocation, the people promised to always care for the land.

The reproduction of genetic code and the processes of evolution can be seen as transformations at different scales. Thanks to the creative forces of evolution, there is a diversity of plants and animals.

Interconnectedness is another theme closely tied to genetics and evolution. A fundamental principle of evolutionary biology is that all things are related. Through the understanding of DNA – the building blocks which all organisms share – and the relationships of organisms through the evolutionary processes, interconnectedness is undeniable.

Biodiversity is closely linked to the transformations brought about through genetics and evolution.

### *Guiding Questions*

- How do First Nations perspectives and knowledge relate to the theory of evolution?
- In what ways do First Nations stories relate to the relationships between organisms, the common ancestor concept and how organisms change over time? (sharing stories)
- How are biodiversity and evolution interconnected?
- How has the genetic biodiversity of organisms due to BC's diverse geography helped BC First Peoples sustain life for thousands of years?

UNIT 2 • TRANSFORMATION, GENETICS AND EVOLUTION

Relevant BC Learning Standards for Senior Secondary Science

Course	Key Content Standards	Key Curricular Competencies
Science 10	<ul style="list-style-type: none"> <li>DNA structure and function</li> <li>Patterns of inheritance</li> <li>Mechanisms for the diversity of life: mutation and its impact on evolution; natural selection and artificial selection</li> <li>Applied genetics and ethical considerations</li> </ul>	<p><b>Questioning and predicting:</b></p> <ul style="list-style-type: none"> <li>Make observation aimed at identifying their own questions, including increasingly abstract ones, about the natural world.</li> </ul> <p><b>Planning and conducting:</b></p> <ul style="list-style-type: none"> <li>Collaboratively and individually plan, select and use appropriate investigation methods, including field work and lab experiments, to collect reliable data.</li> </ul> <p><b>Processing and analyzing data and information:</b></p> <ul style="list-style-type: none"> <li>Experience and interpret the local environment;</li> <li>Apply First Peoples perspectives and knowledge, other ways of knowing and local knowledge as sources of information</li> </ul> <p><b>Evaluating:</b></p> <ul style="list-style-type: none"> <li>Consider social, ethical, and environmental implications of the findings from their own and others' investigations</li> </ul> <p><b>Applying and innovating:</b></p> <ul style="list-style-type: none"> <li>Contribute to finding solutions to problems at a local and/or global level through inquiry</li> </ul> <p><b>Communicating:</b></p> <ul style="list-style-type: none"> <li>Express and reflect on a variety of experiences, perspectives, and worldviews through place.</li> </ul>
Life Science 11	<p><b>Microevolution:</b></p> <ul style="list-style-type: none"> <li>Adaptation to changing environments</li> <li>Changes in DNA</li> <li>Natural selection</li> </ul> <p><b>Macroevolution:</b></p> <ul style="list-style-type: none"> <li>Speciation</li> <li>Processes of macroevolution</li> <li>Evidence for macroevolution</li> </ul>	
Anatomy and Physiology 12	<ul style="list-style-type: none"> <li>DNA</li> <li>Gene expression</li> </ul>	



## Resources

For further information on these resources, see the annotations in the Bibliography, beginning on page 273.

### Suggested Resources

#### Classroom Resources

- A variety of images of living things, some closely related, some, such as wolf, husky, cedar, salmon.

#### Narratives

- First Nations origin and creation narratives, such as:
  - The woman who fell from the sky
  - Raven and coyote origin stories
  - Raven Steals the Light. Told by Bill Reid and Robert Bringhurst. Canadian Museum of History website with permission at <https://bit.ly/2R7YVoj>
  - The Winter Hunter and the Mosquitoes. Franz Boas, Tsimshian Mythology, 1916. Online at [archive.org](https://archive.org): <https://bit.ly/2FyD7kD>
  - The Winter Hunter and the Mosquitoes. Canadian Museum of History, condensed version, adapted from the version published by Franz Boas. Online at <https://bit.ly/2Dj9z8d>
  - *Stories from People of the Land: Legends of the Four Host First Nations*. Theytus, 2009.

#### Print

- Amaron, Beryl. *More Than Useable Tools: Towards an Appreciation of Nle?kepmx Fibre Technology as a Significant Expression of Culture*. UNBC Masters Thesis, 2000. Linked at <https://bit.ly/2ZiD8Px>.
- *Globe and Mail*. “Microbe reveals ‘major new branch’ of evolutionary tree, Halifax researchers say,” November 14, 2018. <https://tgam.ca/2Hs2lmo>
- King, Thomas. *The Truth About Stories*. House of Anansi, 2003. Also as podcast, *The Truth About Stories*. CBC Massey Lectures, 2003. <https://bit.ly/2Q30IKY>
- *Kokanee of British Columbia*. Wild BC, 2004.
- Olsen, Sylvia. *Working With Wool*. Sono Nis, 2010.
- *People of the Land: Legends of the Four Host First Nations*. Theytus, 2009.
- *Taking Nature's Pulse: The Status of Biodiversity in British Columbia*. Biodiversity BC website. <https://tinyurl.com/fnesc20>.

#### Websites

- The Truth About Stories. Thomas King <https://bit.ly/2Q30IKY>.
- *First Voices*. <http://www.firstvoices.com>
- Genetics Home Reference site. <https://tinyurl.com/fnesc14>.

## UNIT 2 • TRANSFORMATION, GENETICS AND EVOLUTION

- Williams, Shawna. "Study Finds Epigenetic Differences Between Hatchery-Raised and Wild-Born Salmon," *The Scientist*, 2018. <https://bit.ly/2XpW8uM>
- Golden Spruce narrative at artist April White website (www.aprilwhite.com) at <https://bit.ly/2Kslbsj>
- McKnight, Zoe. "Whatever Happened to Haida Gwaii's Revered Golden Spruce?" *The Vancouver Sun*, 09-29-2012. <https://bit.ly/318WQyH>
- Kiidk'yaas, the Golden Spruce. Atlas Obscura. <https://tinyurl.com/fnesc57>.

### Extracting DNA websites

- Extracting DNA from Strawberries Experiment. The Home School Scientist, 2012. <https://bit.ly/2HH77uw>
- How to Extract DNA From Anything Living. Learn.Genetics, University of Utah. <https://bit.ly/2SPwfGo>
- Squishy Science: Extract DNA from Smashed Strawberries. Scientific American, 2013. <https://bit.ly/2DI9USI>

### Stickleback websites and videos

- BC Species and Ecosystems Explorer. <https://tinyurl.com/fnesc55>
- Making of the Fittest: Evolution of the Stickleback Fish. 15:38 min. BioInteractive Video <https://www.youtube.com/watch?v=Pv4Ca-f4W9Q>
- *Meet the Threespine Stickleback*, linked at <https://tinyurl.com/fnesc50>.
- Natural Selection Still Going Strong. <https://tinyurl.com/fnesc51>.
- Stickleback Evolution Virtual Lab app. iOS app
- Stickleback Pairs Fact Sheet. <https://tinyurl.com/fnesc53>
- "Stickleback Species Pairs." This 6 page illustrated brochure was published by the BC Government in 1999. <https://tinyurl.com/fnesc52>.

### Evolution of Corn websites

- Evolution of Corn. Learn.Genetics. <https://bit.ly/2rAtVDi>
- "Tracking the Ancestry of Corn Back 9,000 Years." *The New York Times*, 2010. <https://nyti.ms/2OuacTD>
- "A Single Domestication For Maize Shown by Multilocus Microsatellite Genotyping." *Proceedings of the National Academy of Sciences*, 2002. <https://bit.ly/2HDAkq6>

### The Story of the Salish Woolly Dog websites

- The Fort Victoria Journal. <http://www.fortvictoriajournal.ca/gallery.php>
- Rare Woolly Dog Hair Found in Coast Salish Blanket. Burke Museum, 2017. 1.23 min. <https://youtu.be/W-7xcnyaZmU>
- Barsh, Russel. The Coast Salish Woolly Dogs Historylink.org, 2016. <https://tinyurl.com/fnesc11>.
- Early Canid Domestication: The Farm-Fox Experiment. Lyudmila N. Trut. *American Scientist*, Vol. 87, No. 2, pp. 160-169 . <https://bit.ly/2XdBYUE>

## UNIT 2 • TRANSFORMATION, GENETICS AND EVOLUTION

### *Blackline Masters*

- 2-1 Levels of Biodiversity
- 2-2 Combination Notes
- 2-4 Cladograms
- 2-5 Marine Animals
- 2-6 Forest Animals

### **Outline of Activities**

- 2.1 Start with a Story – Transformation Narratives
- 2.2 Transformation, Genetics and Evolution
- 2.3 Connecting Evolution, Biodiversity and First Peoples
- 2.4 Representing Relationships: Cladograms
- 2.5 Stickleback Stories
- 2.6 The Story of the Salish Woolly Dog
- 2.7 The Evolution of Corn
- 2.8 Fisheries or Conservation Officer Interview
- 2.9 Further Topics for Inquiry

## Suggested Activities

Note: There are more activities here than most teachers will incorporate into their units. It is not expected that you will use all of the activities, or follow the sequence as it is described. These activities are intended to be adapted to fit the needs of your students and classroom, as well as inspire ways that you can respectfully include relevant Indigenous knowledge and perspectives in your course.

### Activity 2.1

#### Start with a Story: Transformation Narratives

Students will experience a traditional First Nations narrative that illustrates transformation.

- a. If possible, invite a local First Nations storyteller to tell a story that includes the idea of transformation.
  - Ensure that the visitor is informed about the topic, and understands the purpose of the activity. Discuss with them what they would like to contribute to the learning conversation. This may be personal stories, traditional stories or experiences.
  - Ensure that the students are responsive with questions at the end. This can also be done by having students send questions to the storyteller beforehand.
  - Be sure to discuss any individual roles students need to preform before during and after the visit, such as meeting the speaker at the door of the school, guiding them to the classroom, making sure they are comfortable, behaviour expectations during the visit, observing protocols around compensation, etc.
  - For more information about protocols for inviting First Nations Elders and knowledge-keepers into the class, see Part One, Foundations, page 19.
- b. If it is not possible to meet with a storyteller, have students read or listen to a traditional narrative that includes the theme of transformation. If possible, find a story that comes from your local region.
- c. For a unique perspective on stories and storytelling, students can experience a traditional creation story told by Thomas King from his book *The Truth About Stories*. He compares the story The Woman Who Fell From the Sky with the creation story from Genesis.
  - If possible, students can listen to Thomas King tell the story. It is available as a podcast online at <https://bit.ly/2Q30IKY>
    - The pertinent section starts at 17:30 minutes. There are several places to stop, but one suggested place is at the 36:30 minute mark.



**Foundations**  
For more about protocols for inviting First Nations Elders and knowledge-keepers into the class, see page 19.

For ideas about using Narratives, see page 24.



**Formative Assessment Strategy**

Are students able to verbally explain why specific protocols are important to follow when a knowledge-keeper visits a classroom?

## UNIT 2 • TRANSFORMATION, GENETICS AND EVOLUTION

- Alternatively students could read the section in the book, or you could read it aloud to them. The section begins on page 10 starting at “So you have to be careful with the stories you tell.” and the suggested ending is on page 23 after the second paragraph.
  - Discuss with the class how the stories reflect the values of the societies that created them.
- d. After listening to, reading or viewing the story, have students discuss or record their initial reactions. Ask questions such as:
- What impressed you about this story? What did you find interesting, curious, surprising?
  - What questions do you have about the story?
  - How does this story reflect place? In other words, how are things like the geography, climate, plants and animals where the people live reflected in the story?
  - What does this story have to do with science?
- d. Have students read or listen to the story again. Ask them to identify examples of Indigenous scientific knowledge that are embedded in the story.
- e. Discuss how the idea of transformation is dealt with in the story.
- What aspect of existence is described in this story?
  - How does this transformation change over the course of the story?
  - What outside force or influence caused this transformation? Is there a source of energy that causes the transformation?
  - How did the changes that occurred impact the aspect of existence or the world in general? If not stated explicitly in the story, state your own opinion.
- f. Have students work cooperatively to compare different transformation stories. They could use the jigsaw strategy.
- Students could work in expert groups, with each group reading or listening to a different story. Students would then move into sharing groups with each member describing the story they studied in regards to the aspects of transformation and Indigenous scientific knowledge found in the story.



### Formative Assessment Strategy

Use the Think-Pair-Share strategy to assess students' initial understanding of the narrative.

The following are some suggested narratives that you could use for students to consider the concept of transformation. These are just a few examples to suggest how transformation narratives might be used.

### The Winter Hunters and the Mosquito

Summary: In this Ts'msyen story a group of hunters and their wives encounter a village of unusual people in the mountains. After one of their babies dies, the people escape the village and cause avalanches to destroy the people, who they discover are mosquito people (but human size). They kill the chief and throw his remains on the fire. The ashes are transformed into tiny mosquitoes.

## UNIT 2 • TRANSFORMATION, GENETICS AND EVOLUTION

- There are two printed versions of the story.
  - The original version in Franz Boas, *Tsimshian Mythology*, published in 1916. Available online at [archive.org: https://bit.ly/2FyD7kD](https://bit.ly/2FyD7kD)
  - Canadian Museum of History, condensed version, adapted from the version published by Franz Boas. Online at <https://bit.ly/2Dj9z8d>
- Examples of Indigenous scientific knowledge embedded in the narrative include:
  - making and using snowshoes for mobility
  - understanding the nature of snow that can cause dangerous avalanches
  - shells can be used to make knives.
  - the significance of the number four
  - the physiology of the mosquito, especially the proboscis
- The main transformation is the creation of the mosquitoes as we know them from the ashes of the chief of the mosquito people. The energy causing the transformation appears to be fire. Other transformations could include the change of snowbanks into an avalanche, caused by the people loosening the snow, and the forces of gravity. Students may also consider that the Chief's heart was transformed into a separate entity when it was removed from his body.
- A different version of the origin of mosquitoes is found in the book *People of the Land: Legends of the Four Host Nations*. The Musqueam story Qelqelil, pages 53-68, tells how some careless children are captured by an old giant woman to be cooked for her dinner. However, they manage to push her into the fire and her ashes are transformed into mosquitoes, and like the old woman, are always seeking blood.

### Spences Bridge story of Transformers: Sesulián and Sekúlia

Summary: In this piece from a very old narrative, two Transformers visit the Fraser River near Lytton to teach humans how to make and use tools. One man made fun of the Transformers, so they transform him, his house and family into stone.

- Find this story reprinted in Beryl Amaron, "More Than Useable Tools: Towards an Appreciation of Nl̓eʔkepmx Fibre Technology as a Significant Expression of Culture" (UNBC Masters Thesis 2000), pages 179-180 (pdf pages 185-186) available at <https://bit.ly/2ZiD8Px>. Also in the original 1917 publication at archive.org: <https://bit.ly/31fx0Jy>
- Some features of note in this story:
  - The people lived in "underground lodges," also known as pit houses.
  - It refers to a particular breed of dog that didn't bark. Presumably evidence of selective breeding of canines by First Peoples. See Activity 2.6 below.
  - People were punished for being disrespectful.
  - Stories are linked to the land, evidenced by the impressions of human

## UNIT 2 • TRANSFORMATION, GENETICS AND EVOLUTION

feet that can be seen in the rocks in the area. Presumably a rock formation today represents the people turned to stone, although that is not mentioned in the story.

- The Transformers instructed the people by making patterns.

---

### Raven Steals the Light

This is a very well-known story, shared by many First Nations. One accessible source is the Haida version, told by Bill Reid and Robert Bringhurst. It is reproduced on the Canadian Museum of History website with permission at <https://bit.ly/2R7YVoj>

---

### Stories from People of the Land: Legends of the Four Host First Nations

The Transformer Story of Lil'wat People: Creation of Lil'wat Territory, pages 13-19.

- Two brothers and their sister, known as the Transformers, shaped the land of Lil'wat people, leaving landmarks that can be identified today. At the same time, they instruct the people on how to harvest resources from the land.

Coyote, (Lil'wat), pages 22-43.

- This story tells different adventures of Coyote, the trickster/transformer character. First, he attempts to create a son out of different materials from the land – mud, rock, pitch and finally cottonwood bark (teaching an understanding of the different properties of these materials). Then Coyote and his son go on a journey and a variety of transformations happen along the way.

The Young Girl That Transformed into a Wolf (Musqueam), pages 49-50.

- A short version of story in which a girl, tired of always having to hunt deer for her family, transforms into a wolf.

Qelqelil (Musqueam), pages 53-68. See notes under The Winter Hunters and the Mosquitoes, above.

Smwkwa'a7 The Great Blue Heron (Squamish), pages 75-78.

- The Transformers are preparing the world for the coming of the people, and they transform a grumpy old man into the Great Blue Heron.

Sch'ich'iyúy The Sisters Mountain (Squamish), pages 82-90.

- This tells the story of the transformation of two sisters into the two prominent mountain peaks visible from Vancouver, called by the Squamish the Sisters, but commonly known today as the Lions.

Tsleil-Waututh Nation Story of Creation, pages 97-101

- The first man and woman are created as a result of transformations of aspects of the natural world.

## Activity 2.2

### Transformation, Genetics and Evolution

---

 **Foundations**  
Find out more about First Peoples perspectives on Transformation, page 16.

a. Thinking about Transformation.

To delve deeper into the concept of Transformation from an Indigenous perspective, you can use one or more of the activities found in Activity 1.3, Circles of Life: Transformation and Renewal (Unit 1, page 42).

b. Ask students what transformations are involved in genetics. What transformations are involved in evolution? (For example, genes transform elements and molecules into proteins – gene expression – which then go on to transform the body in myriad ways. In evolution, one form of an organism is transformed into a new and unique form over time.)

- If you are just beginning the study of these topics, you could return to the questions later in the unit.

c. Ask students to identify some of the effects of genetic transformations on the natural world. Encourage them to think of a diversity of effects (e.g. responsible for evolution; brings about diversity in living things; sometimes has negative effects).

d. Discuss how genetic transformations might be viewed from an Indigenous perspective and a Western science perspective. Would there be similarities and differences? (For example, an Indigenous view might take a holistic perspective, looking at the big picture, while Western science may focus more on the specific processes involved. An Indigenous perspective may also take in other dimensions such as spiritual connections.)

e. Extracting DNA Lab

Students can conduct a lab activity that involves extracting the DNA from organic matter. There are a number of online sites that provide directions for such an activity. They involve a series of steps using readily available chemicals such as laundry detergent and rubbing alcohol to precipitate strands of DNA. Some sites are:

- Extracting DNA from Strawberries Experiment. The Home School Scientist, 2012. <https://bit.ly/2HH77uw>
- How to Extract DNA From Anything Living. Learn.Genetics, University of Utah. <https://bit.ly/2SPwfGo>
- Squishy Science: Extract DNA from Smashed Strawberries. Scientific American, 2013. <https://bit.ly/2DI9USI>

e. Have students formulate some questions they have about the role of transformation in genetics and evolution. They may work individually, in groups or as a whole class.

- Discuss how these questions might be answered.
- Return to these questions at the end of the unit. Have students reflect on how they have been answered, or transformed into further questions.

 **Lab Activity**

 **Formative Assessment Strategy**  
Use students' questions to assess their understanding of the connections between transformation, genetics and evolution.





## Activity 2.3

### Connecting Evolution, Biodiversity and First Peoples

- a. Discuss with students what they understand about the concept of biodiversity. You could hold a class discussion, students could work in groups to come up with a working definition, or students could work individually to reflect on their own understanding of the term.
- b. Have students consider three levels of biodiversity: genetic diversity, species diversity and ecosystem diversity. (Note that some sources include a fourth level, functional diversity, which is how species get food and use the resources of an ecosystem.)
  - Students can use Blackline Master 2-1, page 78, *Levels of Biodiversity*, to help develop their thinking.
  - Students can use their background knowledge to suggest some aspects of the three components.
  - Discuss ways that the three levels are connected. (For example, they demonstrate different levels of viewing organisms; the health of biodiversity of each level is interconnected; all the elements work together.)
  - After students have considered the three levels on their own, they can read more about them in the document *Taking Nature's Pulse: The Status of Biodiversity in British Columbia*. See pages 6-7 (pages 38-39 of the PDF).
    - *Taking Nature's Pulse* is a 2008 document that gives background to what biodiversity is from a BC perspective, and analyses the state of biodiversity as it was at that time. Section 2.4 focuses on genetic diversity in BC.
    - The document is available at the Biodiversity BC website, [www.biodiversitybc.org](http://www.biodiversitybc.org) or linked directly at <https://tinyurl.com/fnesc20>.
  - Ask students what role interconnectedness plays in the components of biodiversity.
  - Ask students to represent the three levels of biodiversity in a diagram or illustration. Note that *Taking Nature's Pulse* uses a pyramid to represent the relationship. Ask students to suggest other forms they could use to illustrate the relationships between the three levels.
- c. Biodiversity Walk.
  - Take students on a biodiversity walk around the school or neighbourhood. Ask them to view their environment through the lens of biodiversity.
  - They can work individually or in groups to see how many different species they can observe.
  - Ask questions such as:
    - What do you observe when you take a broad or wide-angle view of the ecosystem?

 **Formative Assessment**  
Assess students' prior knowledge of "biodiversity." Students can assess how well they understand the meaning and importance of biodiversity. Later they can review their understandings to assess their growth.

 Blackline Master 2-1, page 78, *Thinking About Biodiversity*

 *Taking Nature's Pulse*, Biodiversity BC. Online at <https://tinyurl.com/fnesc20>

 **Land-based Activity**  
Biodiversity Walk

## UNIT 2 • TRANSFORMATION, GENETICS AND EVOLUTION

- What do you observe when you take a close-up view? (If you have magnifying glasses students could use them to view a part of the soil or a tree.)
  - Did you see evidence of a species, but not the species itself? (For example, nest, cocoon, web)
  - After the walk, either in the field or back in the class, discuss the species they might have missed. Ask them to estimate the percentage of biodiversity that they did not see or was hidden.
    - Have students read, or read to them if you don't have copies in the field the text box on page 88 (PDF page 120) of *Taking Nature's Pulse*. (It explains that it is estimated that every square meter of soil in BC has 2 million invertebrates living in it.)
    - Discuss the role that these hidden invertebrates play in an ecosystem. What could happen if there is a loss of biodiversity?
  - Students can write a reflection or journal entry noting two or three things they felt or thought about on their biodiversity walk.
- d. Discuss how geography impacts genetic biodiversity in British Columbia. Background: BC's diverse geography, with many island and isolated mountain valleys, as well as a variety of climates, have been like a laboratory for genetic variation. In many unique ecosystems organisms have adapted to their local habitat.
- Ask students to consider why BC's geography has resulted in a wide range of genetic diversity. (For example, the geography presents different environmental challenges that species have adapted to in diverse ways.)
  - Students can use *Taking Nature's Pulse* to learn more about the genetic diversity in BC.
    - See pages 74- 81 (PDF pages 106-113) and Genetic Diversity, pages 218-219 (PDF pages 250-251).
  - Discuss the connections between BC's geography and the evolution of species in BC.
- e. Importance of Biodiversity to First Peoples.
- Ask students to suggest reasons why biodiversity was, and is, important for First Peoples. They can work in pairs or groups to brainstorm some ideas.
  - Have students read Section 1.3 of *Taking Nature's Pulse*, pages 11 to 15 (43-47 in the PDF) to learn more about why it is important.
  - Students can create a web or mind map to show ways that biodiversity is important to First Peoples. Responses could include:
    - maintaining the natural world was essential for life in the past
    - has an impact on resources of life, including food, technology and medicine.
    - wealth of plants and animals important to world view, such as responsibility to care for the natural world
    - reflected in social structure and arts

## UNIT 2 • TRANSFORMATION, GENETICS AND EVOLUTION

- diversity impacted how the land was used as people moved to different ecosystems to harvest different resources.

### f. Salmon Genetic Diversity

Pacific salmon are extremely important resources for many BC First Peoples. The different species of salmon and steelhead have a tremendous amount of genetic diversity. Maintaining this diversity is essential for maintaining salmon stocks and ensuring they can adapt to changing conditions in the future.

- Ask students to think about how diverse Pacific salmon are genetically. For instance, you could ask, "How different do you think salmon are genetically?"
- Student responses will depend on their prior knowledge of salmon species. If students are familiar with the different species of salmon, they may suggest that each species is genetically different.
- If students have read Genetic Diversity, pages 218-219 (PDF pages 250-251) in *Taking Nature's Pulse* in Activity c) they will recall that according to that 2008 document there more than 400 genetically distinct populations among the five species of salmon.
  - If they haven't read it, you can explain it to them, or have them read it themselves.
- If students are not familiar with the species of salmon and other salmonids such as steelhead, give them an opportunity to find out about some of the characteristics of each species.
  - The Pacific salmon species in BC are: chinook (spring), chum (dog), coho, pink (humpback), sockeye. Kokanee are land-locked salmon. Also related are steelhead and cutthroat trout, sea-going species of trout.
  - You could connect the study of species of salmon with the concept of speciation, the evolutionary process of organisms evolving to form distinct species.
- Ask students to predict what features of a salmon's life history or behaviour might be influenced genetically. Some of those features are:
  - size
  - age at maturity
  - anadromous or not
  - timing of migration to sea
  - direction fry swim when they hatch- upstream or downstream
  - resistance to pathogens
  - homing to natal stream has some genetic component, not fully understood
- Students could investigate the evolutionary story of the kokanee. See the book *Kokanee of British Columbia* (Wild BC), Activity 3, "Why Did Kokanee Evolve From Sockeye Salmon."



**Formative Assessment Strategy**  
Use the Combination Notes activity to assess students understanding of biodiversity and its connections with genetics and evolution.

g. Combination Notes

- Students can use Blackline Master 2-2, page 80, *Combination Notes* to review and summarize what they have learned about the connections between biodiversity, genetics and evolution.
- When they have completed the activity, ask students to reflect on which of the four sections they found the easiest to complete. Ask, why were you most successful at that thinking skill?

## Activity 2.4

### Representing Relationships: Cladograms

The term "All My Relations" is used by many First Peoples to recognize the interconnectedness we have between each other and other species. It also recognizes and honours the people and relationships in our past that helped to shape who we are and have become.

Scientists sometimes use a graphic representation of organisms to indicate relationships, called cladograms. In this activity students use the technique of constructing a cladogram to find evidence of evolutionary relationships.

- Begin the lesson by displaying images of two closely related organisms, such as a wolf and a husky. As a class have students brainstorm a list of characteristics that these animals share. (For example, fur, eyes in front, four legs, tail.)
- Next show a pair of images for two organisms that are not closely related, such as a salmon and a spruce tree. Ask students to brainstorm characteristics that these organisms share. (Examples may be fewer and harder to come up with, but possible responses could be that they are composed of cells, they are living, they reproduce, they are carbon-based.)
- Discuss the differences between the two comparisons. Ask, "What conclusions about how these organisms are related can you draw from the evidence provided in these comparisons?" (Students will likely suggest that wolves and huskies are more closely related to each other than salmon and cedar because they share a greater number of common characteristics.)
- Ask students to consider what characteristics might be identified from an Indigenous Science perspective. (For example, for some First Nations, all play a role in the interconnectedness of a traditional lifestyle; they are all significant in the cultural and spiritual life of the First Peoples.)
- If students are unfamiliar with constructing a cladogram, they could use Blackline Master 2-3, page 81, *Derived Characteristics*, to help them think about shared traits in a number of organisms.
  - The top diagram models the organisms in the discussions above. Make sure students understand the significance of the concentric shapes.





Blackline Master 2-3, page 81, *Derived Characteristics*

## UNIT 2 • TRANSFORMATION, GENETICS AND EVOLUTION

- Students can then decide on four different organisms to put in the bottom diagram, using a similar refinement of traits. Then they can share with a partner and have them identify the traits they see.
- f. Students then build a cladogram. They can draw their own diagram, or use Blackline Master 2-4, page 82, *Cladograms*.
- If students are not familiar with cladograms, explain that they are a way to work out relationships between organisms. It shows how closely or distantly organisms are related in respect to their evolution.
  - If students have worked with Blackline Master 2-1, they can transfer the information to the top cladogram on Blackline Master 2-2, or their own diagram.
- g. Have students work in groups of three or four and distribute a selection of 4 to 6 organism images. You could use Blackline Master 2-5, page 83, *Marine Animals* and Blackline Master 2-6, page 84, *Forest Animals*, to make cards. Students can choose which organisms to work with, or you could distribute them randomly. Alternatively, students could just work with the names of the animals without images.
- Each group will create as many pairings of these organisms as time allows and decide which of the organisms are more closely related by the number of common characteristics they can come up with.
  - Have students create a cladogram using the animals they have chosen or been presented with.
  - Each group will report which pair they thought were most closely related.
  - Key to animals on Blackline masters:
    - Marine Animals: cod, crab, octopus, shrimp or prawn, halibut, abalone, sea urchin, cockle (or clam), salmon, chiton.
    - Forest animals: grizzly bear, beaver, elk, squirrel, loon, moose, porcupine, rabbit or hare, deer, blue jay
- h. Discuss how a cladogram is different from an evolutionary tree. (For example, evolutionary trees show how an organism is related to ancestors and descendants; cladogram shows relationships among organisms.)
- i. Student may be interested to learn about a recent scientific discovery of a microbe that represents a new branch of the evolutionary tree. Rather than giving the organism the usual Latin name, the Dalhousie University scientists who discovered it named it for an important creature in Mi'kmaq cultural traditions. The new discovery is named *Hemimastix kukwesjijk*.
- Students can find out why a Mi'kmaq name was chosen, and what this says about the relationship of scientists today with First Nations.
  - Have students find out the position of this microbe on the evolutionary tree. Ask why its discovery surprised scientists.
  - One source is a newspaper article "Microbe reveals 'major new branch' of evolutionary tree, Halifax researchers say" *Globe and Mail*, November 14, 2018. <https://tgam.ca/2Hs2lmo>

 [Blackline Master 2-4, page 82, Cladograms](#)

 Blackline Master 2-5, page 83, *Marine Animals*  
 Blackline Master 2-6, page 84, *Forest Animals*

Mi'kmaq (Migmaq, Micmac) are the First Nations whose territories include the Maritime provinces, the Gaspé Peninsula of Quebec and northern Maine.

## Activity 2.5

### Stickleback Stories

---

The stickleback is an excellent example of adaptation to the environment, and also of speciation. It is an especially good example of the effects of geographic isolation on genetic adaptation in BC. BC has a number of rare species of stickleback that are only found in one or two lakes. More than that, they have evolved into two separate species adapting to different habits within the lake.

- a. Ask students if they are familiar with a fish called the stickleback. Explain that it is a fish of great interest to scientists because of its noticeable adaptations to different habitats.
- b. Ask students if they know where the community of Sooke, or the T'Souke First Nation is located. Explain that the name of the people comes from t'souke, the traditional name of the stickleback fish in the T'Souke language. The small fish are found in the Sooke River estuary.
  - Chief Gordon Planes has said that the T'Souke people are like the stickleback fish because they are small but strong and stick together. Rather than going extinct they thrive in the ever-changing environment.
  - Ask, how might transformations of the lives of First Nations through colonization be like the evolutionary transformations of the stickleback?
- c. Have students investigate the similarities and differences between marine and freshwater stickleback species. Here are some suggested resources:
  - Natural Selection Still Going Strong. This website has an infographic that illustrates the differences in morphology and shows the genetic connections. <https://tinyurl.com/fnesc51>.
  - *Meet the Threespine Stickleback*, linked at <https://tinyurl.com/fnesc50>. This 3 minute video explains and illustrates the differences. Note that the video is part of a unit, and the ending refers to an activity that will not be relevant to your students.
  - Discuss the purpose of the stickleback's armour – the lateral plates and spines. (Spines and armour plates allow for protection from predators.)
  - Students can illustrate the two types of stickleback, labelling the features that are evidence of evolutionary adaptation.
- d. Species Pairs: The BC Stickleback story.
  - Explain that in a few BC lakes the freshwater stickleback have evolved into two different species. One is benthic, that is, it lives on the bottom of the lake. The other is limnetic, living nearer the surface. Scientists have found that they are distinct species, but are closely related. They call them Species Pairs or Stickleback Pairs. The pairs in each lake where they live are genetically different from pairs in other lakes.
  - Ask student to suggest why freshwater sticklebacks may have evolved into pairs, with some living in a benthic habitat and others in an open water habitat.

 **Cross-Curricular Link**  
This question could link to the study of the effects of colonization in secondary Social Studies courses.

## UNIT 2 • TRANSFORMATION, GENETICS AND EVOLUTION

- Suggest students think of variables in these habitats that might cause adaptations.
- Students can then find out more about the Species Pairs. For example, what are the differences between the pairs? Why did they evolve that way? Students can use one or more of these resources:
  - "Stickleback Species Pairs." This 6 page illustrated brochure was published by the BC Government in 1999. <https://tinyurl.com/fnesc52>.
  - Stickleback Pairs Fact Sheet. This fact sheet gives detailed information on one of the BC Species pairs in Vananda Creek. Linked at <https://tinyurl.com/fnesc53>.
- Discuss how each type of stickleback adapted to its unique habitat.
  - Ask, What are some of the pressures that cause physical characteristics in organisms to change?
- Point out that the BC Stickleback Pairs are on the BC endangered species list.
  - They can explore more about the endangered status of stickleback at the BC Species and Ecosystems Explorer, a BC government website. Go to the link at <https://tinyurl.com/fnesc55> and enter "stickleback" into the name field.
- Discuss why scientists are concerned about the loss of a few fish in a few lakes. (For example, the concept that biodiversity is essential for the natural world as a whole. The unique fish are just as much a part of the interconnectedness of life as other organisms.)
- e. Students can delve deeper into the genetics of the marine and freshwater species by using these resources:
  - Viewing the documentary *Making of the Fittest: Evolution of the Stickleback Fish*. 15:38 min. BioInteractive Video. <https://youtu.be/Pv4Ca-f4W9Q>
    - The video follows scientists who use genetic tracking technologies to explain the differences. They discover the role that gene expression plays.
  - Students can engage in a virtual lab. To explore how scientists study the evolutionary changes in stickleback, students can use the iOS app Stickleback Evolution Virtual Lab.
    - Students participate virtually in three experiments dealing with the changes in pelvic structures in freshwater stickleback.
    - As well, the app includes background information, tutorials, videos and quizzes. Available for free on iOS mobile devices at the Apple app store.
- f. After they have studied the stickleback, have students engage in an activity that demonstrates their learning. some suggestions include:
  - Tell the story of the evolution of the stickleback in a narrative form. This could be the evolution of the marine to freshwater, or the freshwater to Species Pairs, or it could be about both. They could tell the story in a digital format, as a graphic novel or as a book for younger students.



### Formative Assessment Strategy

Use one of these activities to assess students' understanding of key features of evolution as exemplified in the stories of the stickleback in BC.



- Create a poster illustrating adaptations of the stickleback and what habitats these adaptations are best suited to enhance survivability.
- Design a dichotomous key that is a guide to the different species of BC stickleback.

## Activity 2.6

### The Story of the Salish Woolly Dog

---

Students investigate the domestication of dogs, and in particular a unique breed of dog raised by some BC First Nations to supply hair for weaving textiles.

- a. Show students an image of the Paul Kane painting “A Woman Weaving a Blanket.”
  - One good source is the UVic website The Fort Victoria Journal. Scroll down the page to the gallery titled The Songhees (Lekwungen) and Clallam. It is the fifth picture in the top row. It can be downloaded and enlarged to a high resolution. <http://www.fortvictoriajournal.ca/gallery.php>
  - Another source is the web page The Coast Salish Woolly Dogs by Russel Barsh, at Historylink.org, 2016. Online at <https://tinyurl.com/fnesc11>.
  - Explain that this painting is by Paul Kane, who observed a Coast Salish person weaving when he visited Fort Victoria in 1847.
  - Take this opportunity to ask students to find examples of First Nations technological inventions, skills, and evidence of Indigenous scientific knowledge illustrated in the picture. For example, loom and weaving (properties of textiles), bentwood boxes, spindle whorl (physics).
  - Explain that this painting is a rare image of a unique dog known as the Salish woolly dog (or Salish wool dog). The wool that is being spun and woven is largely made out of the hair from these dogs, which were bred and raised especially for their hair.
- b. Ask students to write down some questions about the Salish Woolly Dog. Then have them find out more about how the dogs were raised and utilized. Sources include:
  - Sylvia Olsen, *Working with Wool*, pages 53-55.
  - Russel Barsh, The Coast Salish Woolly Dogs at <https://tinyurl.com/fnesc11>.
  - Andrea Merrill. "Behind the Breed: Salish Wool Dog." Animals of the Pacific Northwest website, 2019. <https://tinyurl.com/fnesc12>.
  - *Coast Salish Wool Dog Poster*. UBC Biology. <https://tinyurl.com/fnesc13>
- c. Students can share their findings in groups or with the whole class. Ask questions such as:
  - How did the Coast Salish people make sure Woolly dogs didn't interbreed with other dogs?
  - Why aren't there Salish Woolly Dogs alive today?



## UNIT 2 • TRANSFORMATION, GENETICS AND EVOLUTION

- What does the story of the Salish Woolly Dog tell you about First Peoples' understandings about selective breeding?
- d. Students can present their findings about the Salish Woolly Dog in a project suitable for elementary school children.
  - They should choose their audience: for instance will it be for very young children or those in Grades 4 or 5?
  - They should decide on a format, such as a book, poster, digital presentation or other format.
  - If possible have students share their projects with children of the appropriate age and get their feedback.
- e. Student can research another breed of dog unique to BC, the Tahltan Hunting Dog. This story has a twist because some people claim to be breeding this dog today, even though most recognize it as extinct.
- f. Students can investigate a scientific study that investigated the transformation of wild canines into domestic animals. It asks, what factors led domestic dogs to be tame?
  - Have students read the scientific article *Early Canid Domestication: The Farm-Fox Experiment*. You could download and prepare copies for students, or they could read it online.
    - Article source: Early Canid Domestication: The Farm-Fox Experiment: Foxes bred for tamability in a 40-year experiment exhibit remarkable transformations that suggest an interplay between behavioral genetics and development. Lyudmila N. Trut. *American Scientist*, Vol. 87, No. 2, pp. 160-169
    - The article is available for download at <https://bit.ly/2XdBYUE>
  - Questions for consideration during this case study could include:
    - Whose intention was it to domesticate the canids: the humans or the animals? Make a case for both.
    - Which characteristics were being selected for?
    - In the domesticated version, which characteristics began to change from the wild organism?
    - How did the experimenters ensure that tameness was a result of genetic change?
    - How did the ratio of tame to un-tame foxes change over the forty year experiment?
    - How does the change in genotype affect the phenotype of the domesticated organism?
    - How did domestication affect the hormones produced by the adrenal glands in the foxes? How did this affect their behaviour?
    - How did domestication change the breeding patterns of the organisms?
  - Bring the class together to discuss how artificial selection of their organism was completed and how the changes affected future generation.

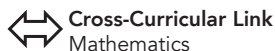

- Math Connections. Students can extract the data from the article and creating a graph that shows the relationship between tame and wild organisms. Students can also use this to draw conclusions as to the success or failure of the experiment to achieve its purpose.
- g. Who selects who? Students can debate the question: Is it the animals or the people doing the domesticating?
- This can be done as a modified talking circle. After studying one or more of the activities relating to the selective breeding of canines, students can develop arguments to support one side of the question.
  - Half of the class can develop an argument around the idea that the animals actually began to domesticate humans for the benefit of the animals themselves. The idea of who benefits more from the pairing of humans and domesticated animals is a powerful argument for this side.
  - The other half the class can argue that it was in fact the humans who began the process, being conscious beings.
  - First Peoples knowledge of the intelligibility of nature can be discussed in this activity as well, being used by both sides of the argument.

## Activity 2.7

### The Evolution of Corn

---

Students investigate the Indigenous domestication of corn or maize as an example of artificial selection.

- a. Write the following words on the board and ask students what these all have in common:
- avocado, chocolate, corn, peanut, peppers, potato, squash, tomato
- After they have made some suggestions, explain that they are all plants that were domesticated by Indigenous people in the Americas.
  - Discuss how significant these foods are globally. (For example, they are very common around the world and are fundamental to much of the world's cuisine.)
  - Ask students what kinds of scientific knowledge would people like the Aztecs and Mayans have had to successfully domesticate these plants. (For example, they would have had to know how to selectively breed succeeding generations of plants to produce desired characteristics.)
  - Review or introduce the concepts of natural and artificial selection.
- b. Have students investigate the story of how corn or maize was domesticated, and how scientists tracked down the single original plant that all corn is derived from (teosinte).
- The research could be split up between students, with some finding out

## UNIT 2 • TRANSFORMATION, GENETICS AND EVOLUTION

about how it was domesticated, and others research the genetic archaeology used to identify its original ancestor.

- Students can find many sources of information about the development of corn. Some places to start are:
  - Evolution of Corn. Learn.Genetics. <https://bit.ly/2rAtVDi>
  - "Tracking the Ancestry of Corn Back 9,000 Years." The New York Times, 2010. <https://nyti.ms/2OuacTD>
  - "A Single Domestication For Maize Shown by Multilocus Microsatellite Genotyping." Proceedings of the National Academy of Sciences, 2002. <https://bit.ly/2HDAkq6>
- c. Rather than just focussing on corn, students could also investigate how artificial selection was used to domesticate other food plants that originated in the Americas. These plants include:
  - amaranth, avocado, cassava, chia, chocolate, corn, papaya, peanut, peppers, pineapple, potato, quinoa, squash, sunflower, sweet potato, tomatillo, tomato
  - Note that the domestication of some of these plants is not well understood and may be more difficult to research.
- d. Students can develop their own questions to guide their inquiry. Here are some suggested questions they could start with:
  - What was the intention of the First Peoples in developing this agricultural resource? How did they inform their decisions?
  - Which characteristics were being selected for?
  - In the domesticated version, which characteristics began to change from the wild organism?
  - How does the change in genotype affect the phenotype of the domesticated organism?
  - How did domestication change the breeding patterns of the organisms?
- d. Students can decide how to present their findings to be shared with the rest of the class, or another audience. Encourage students to use some kind of narrative form, presenting the information as a story.
- f. You may want to connect the study of the domestication of corn with the Indigenous knowledge inherent in the Three Sisters story, which involves the companion planting of corn, beans and squash. See Unit 7, Activity 7.11, page 199.

 **Unit Link**  
See the Three Sisters story in Unit 7, Connecting Food Security and Climate Change, page 199

## Activity 2.8

### Fisheries or Conservation Officer Interview

---

This lesson will provide students with a grasp of the diversity of living organisms that exist in their local area and the benefits reaped by the community of this diversity.



#### Field Trip Activity

- a. Prepare by arranging a visit with a local fisheries officer or conservation from the community. This could be as a classroom visit by the fisheries officer, or if possible students could make a field trip to the fisheries office as a field trip or at a location important to the fisheries department.
- b. Identify and set up a time for the local officer from the community to visit the class, or for the class to visit the officer (weather and access permitting).
- c. Prepare the speaker as to the focus of the talk, such as diversity of local species, harvesting seasons, harvesting techniques, changes in behaviours and numbers of local species over time.
- d. Prepare students beforehand with a discussion on how evolution has created the diversity of life we see and that this diversity is beneficial to humans and worth maintaining. (cross reference to ethnobotany unit for discussion on biodiversity)
  - Generate with the class a list of questions that can be asked after the speaker is finished.
  - Multiple students can be given the same question, but all will listen to the presentation with an ear to answering their given question.
- e. If the speaker does not answer the question during the talk, the students are responsible for asking themselves.
- f. If time remains in class after the talk is done, discuss the questions together as a class.
- g. Students can write a report, outlining their findings from both their research and their interview. This may take the form of a video, digital slide presentation, or another format chosen by students.

## Activity 2.9

### Further Topics for Inquiry

---

There are many scientists working in the ever-expanding fields involving genetics and evolution. Students can investigate one of these topics individually or in groups.

- a. What genetic impact did European Contact have on First Peoples?
  - Find out about a gene that plays a role in the immune system, the HLA-DQA1 gene. See Genetics Home Reference site at <https://tinyurl.com/fnesc14>.
  - This scientific article reports on a genetic study involving the DNA of some Ts'msyen people in the Prince Rupert area.
    - "A time transect of exomes from a Native American population before and after European contact." John Lindo et al. Nature Communications, 2016. Linked at <https://tinyurl.com/fnesc56>.
- b. Are there epigenetic differences in hatchery and wild salmon?
  - Students can refer to this article in *The Scientist* which describes the study and reactions by other scientists. Shawna Williams, "Study Finds Epigenetic Differences Between Hatchery-Raised and Wild-Born Salmon," *The Scientist*, 2018. Available at <https://bit.ly/2XpW8uM>
- c. Kiidk'yaas, the Golden Spruce
 

Kiidk'yaas, The Golden Spruce, was a unique tree that existed on Haida Gwaii for 300 years. It was a Sitka spruce with a genetic mutation that resulted in the needles having a golden colour rather than the usual green. When it was felled by a misguided activist there was a great feeling of loss by the Haida people and others.

  - Possible resources:
    - Students can see an artistic image of Kiidk'yaas at the website of Haida artist April White ([www.aprilwhite.com](http://www.aprilwhite.com)). The page includes a summary of the Haida narrative about this unique tree. Available at <https://bit.ly/2KsIbsj>
    - Zoe McKnight, "Whatever Happened to Haida Gwaii's Revered Golden Spruce?" *The Vancouver Sun*, 09-29-2012. <https://bit.ly/318WQyH>
    - Kiidk'yaas, the Golden Spruce. Atlas Obscura. <https://tinyurl.com/fnesc57>.

## Blackline Master 2-1

# Levels of Biodiversity

The word *biodiversity* comes from *biological diversity*. It refers to the diversity of living organisms and their interconnectedness.

The Canadian Biodiversity Strategy defined biodiversity as:

*The variety of species and ecosystems on earth and the ecological processes of which they are a part – including ecosystem, species and genetic diversity.* (Source: Taking Nature's Pulse p 5.)

Use this table to record information about the levels of biodiversity

	Genetic biodiversity	Species biodiversity	Ecosystem biodiversity
Facts and Ideas			
Examples			
Questions			

## Blackline Master 2-1 SAMPLE RESPONSE KEY

# Levels of Biodiversity

The word *biodiversity* comes from *biological diversity*. It refers to the diversity of living organisms and their interconnectedness.

The Canadian Biodiversity Strategy defined biodiversity as:

*The variety of species and ecosystems on earth and the ecological processes of which they are a part – including ecosystem, species and genetic diversity.* (Source: Taking Nature's Pulse p 5.)

Use this table to record information about the levels of biodiversity

	Genetic biodiversity	Species biodiversity	Ecosystem biodiversity
Facts and Ideas	<ul style="list-style-type: none"> <li>- foundation of all biodiversity</li> <li>- toolkit for life</li> <li>- genes change to adapt to changes in environment</li> <li>- changes through natural selection</li> <li>- change through random mutations</li> </ul>	<ul style="list-style-type: none"> <li>- species are units of genetic diversity</li> <li>- mate among themselves but not with others</li> <li>- species adapt to habit through genetics</li> <li>- species are interdependent on other species</li> </ul>	<ul style="list-style-type: none"> <li>- a unique community of many species interacting as one unit</li> <li>- made up of land, water, plants, animals and microorganisms</li> <li>- some regions have few ecosystems (low diversity) and some have higher diversity of ecosystems</li> </ul>
Examples	<ul style="list-style-type: none"> <li>-The white Spirit or Kermode bear is a genetic variation of the black bear</li> </ul>	<ul style="list-style-type: none"> <li>- The coastal wolf is a genetically distinct subspecies of the grey wolf</li> <li>- The woodland caribou is a subspecies of caribou</li> </ul>	<ul style="list-style-type: none"> <li>- A watershed can have a high diversity of ecosystems e.g. alpine, forest, river, grasslands, estuary</li> </ul>
Questions	<ul style="list-style-type: none"> <li>- Why is genetic diversity called the tool kit for life?</li> <li>- Why is genetic diversity important for survival?</li> <li>- How might genetic biodiversity react to climate change?</li> </ul>	<ul style="list-style-type: none"> <li>- What causes a new species to develop?</li> <li>- Why is it important to have species diversity?</li> <li>- What could happen if one species disappeared?</li> </ul>	<ul style="list-style-type: none"> <li>- How high or low is the ecosystem biodiversity in our region?</li> </ul>

# Combination Notes

Record notes about what you have learned in the left column. Use images, sketches or graphics to illustrate the ideas in the right column. Summarize what you have learned at the bottom left, and write questions you still have on the bottom right.

**Subject** \_\_\_\_\_

<b>Notes</b>	<b>Images</b>
<b>Summary</b>	<b>Questions</b>



## Derived Characteristics

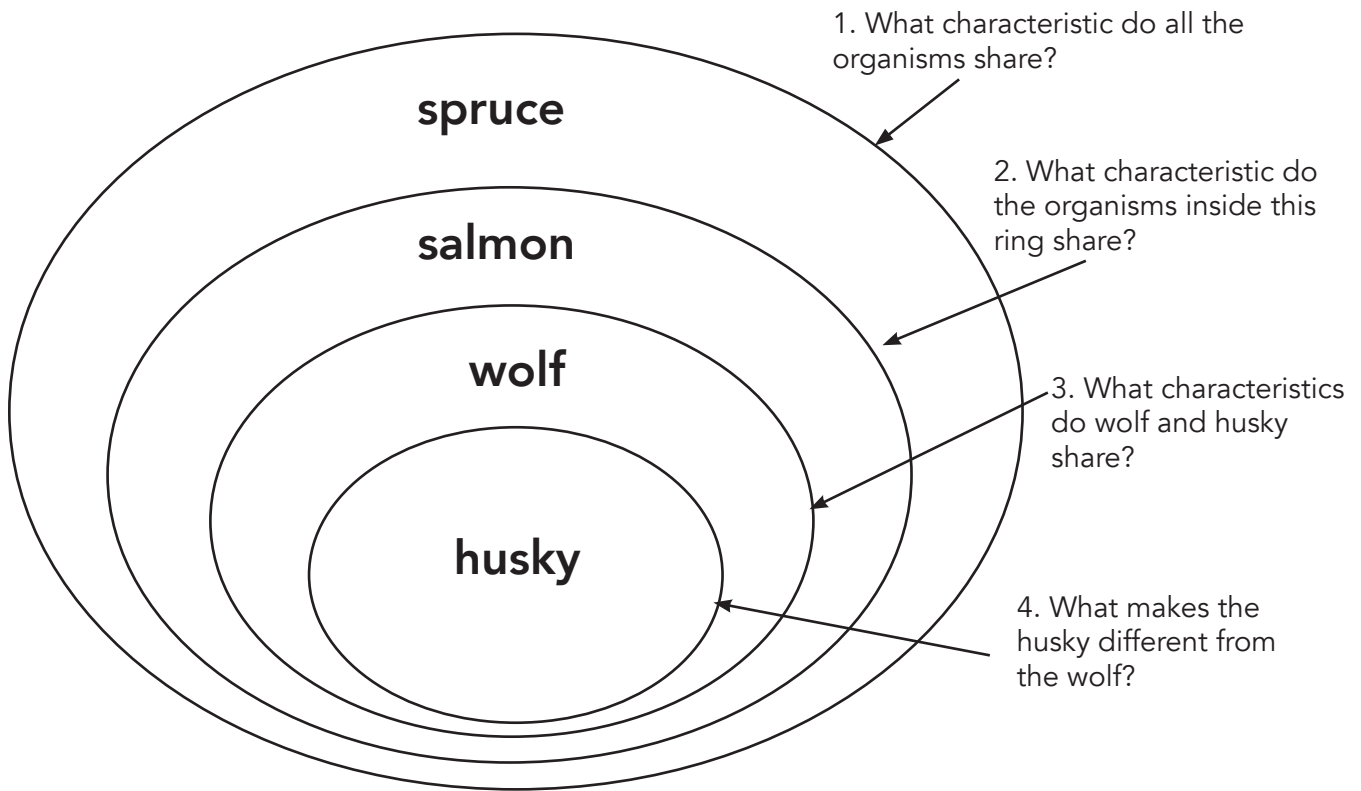

Pick 4 organisms and put their names in the rings. Ask your partner to think of what traits each ring shares.

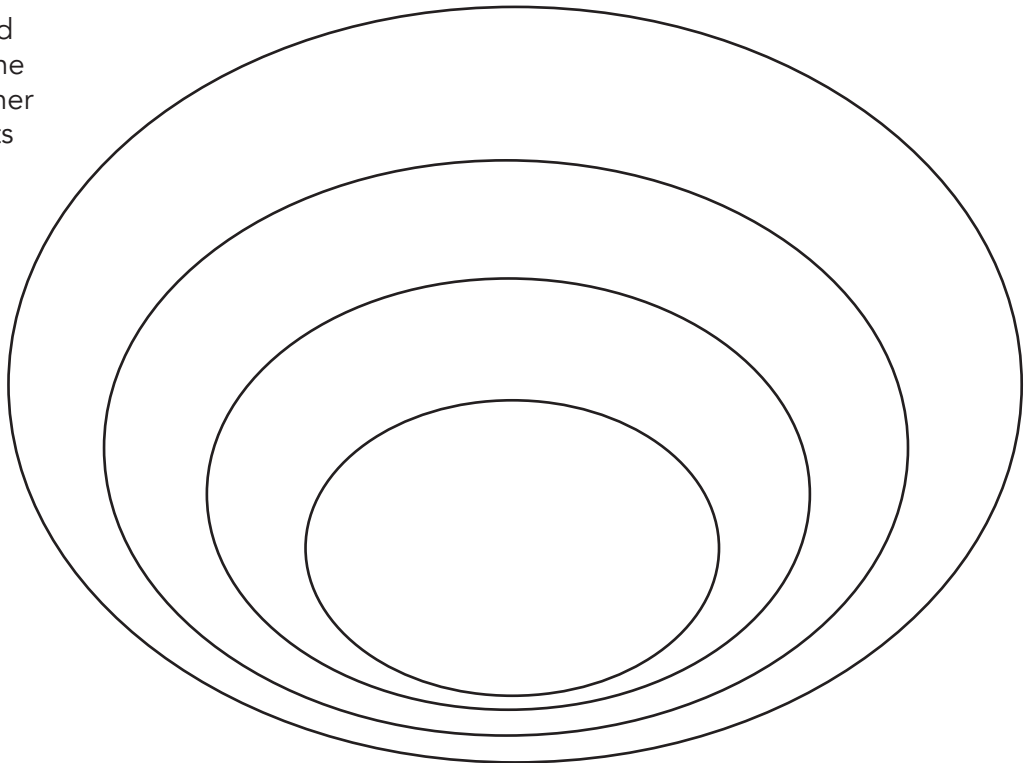

# Cladograms

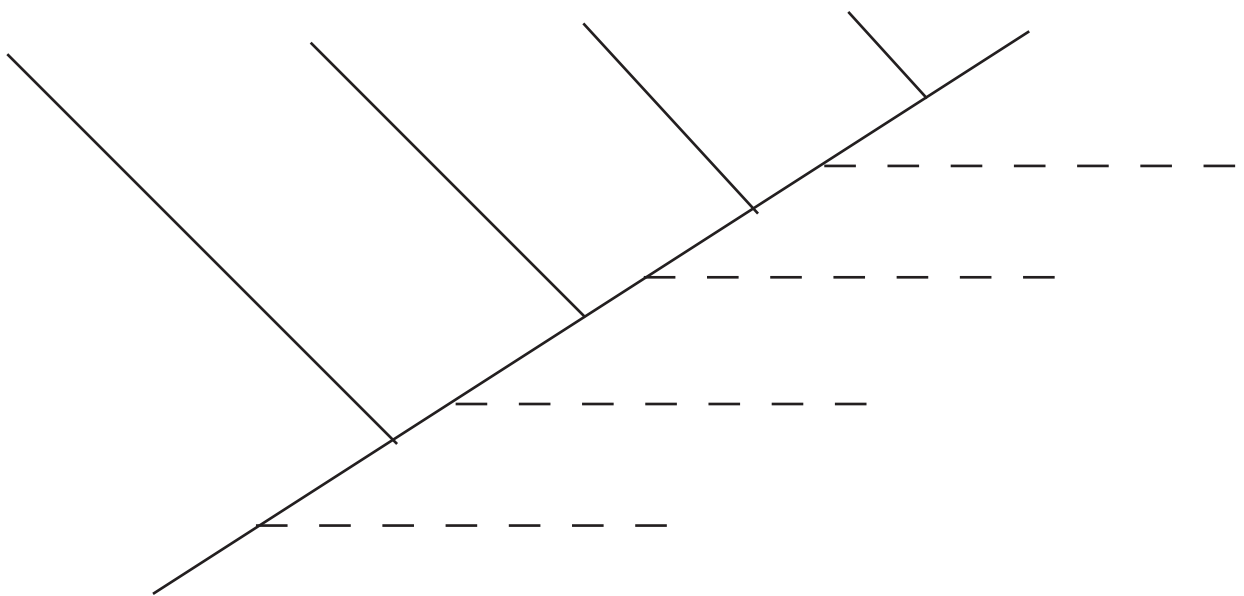
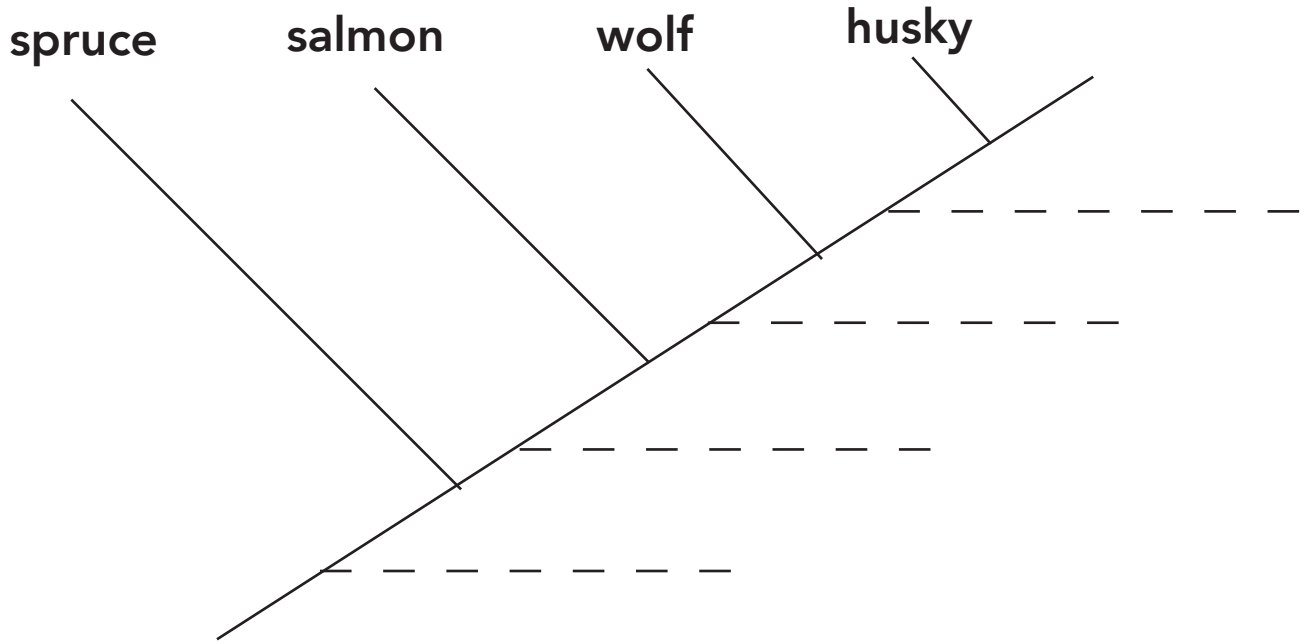

Blackline Master 2-5 **Marine Animals**

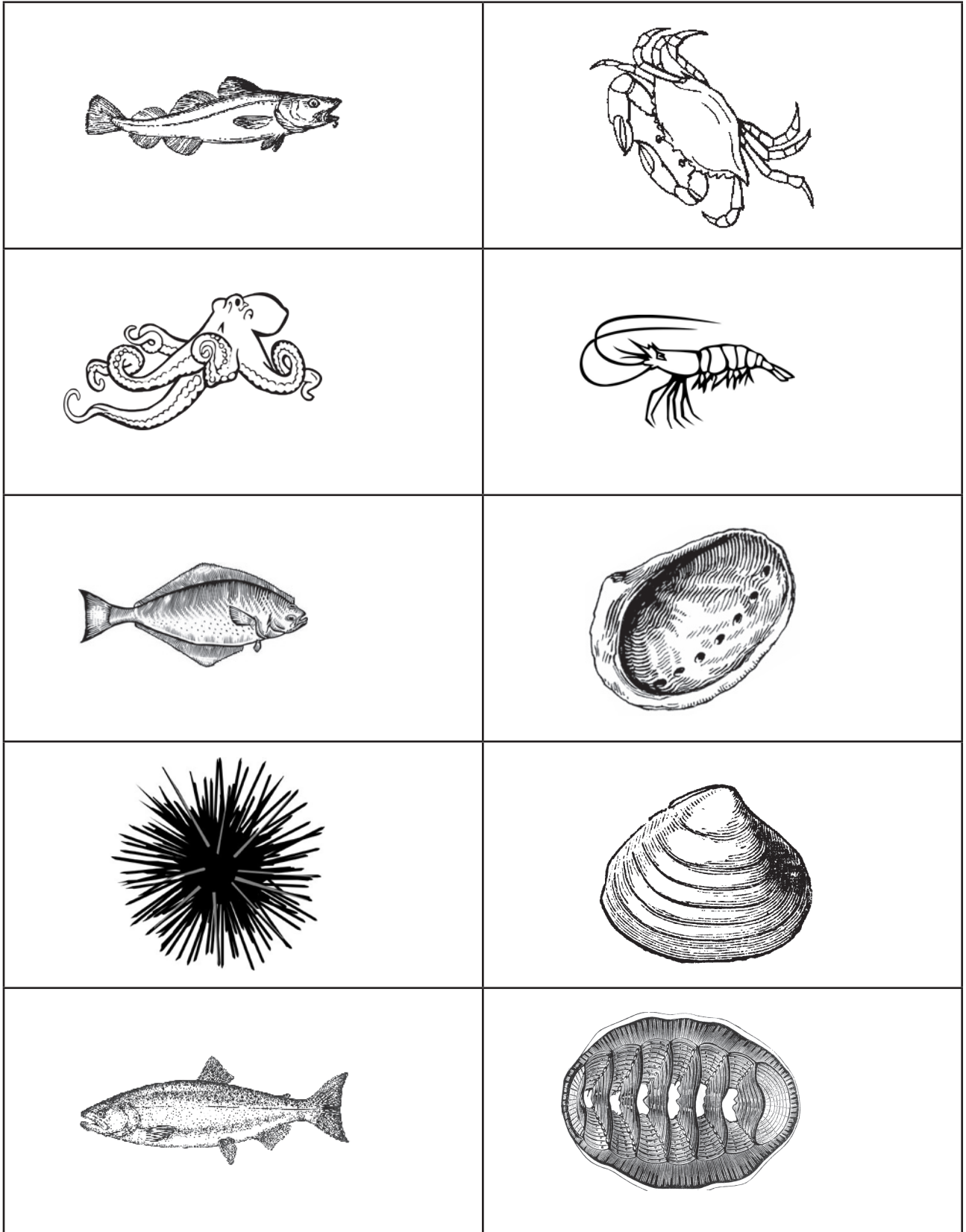

Blackline Master 2-6 Forest Animals

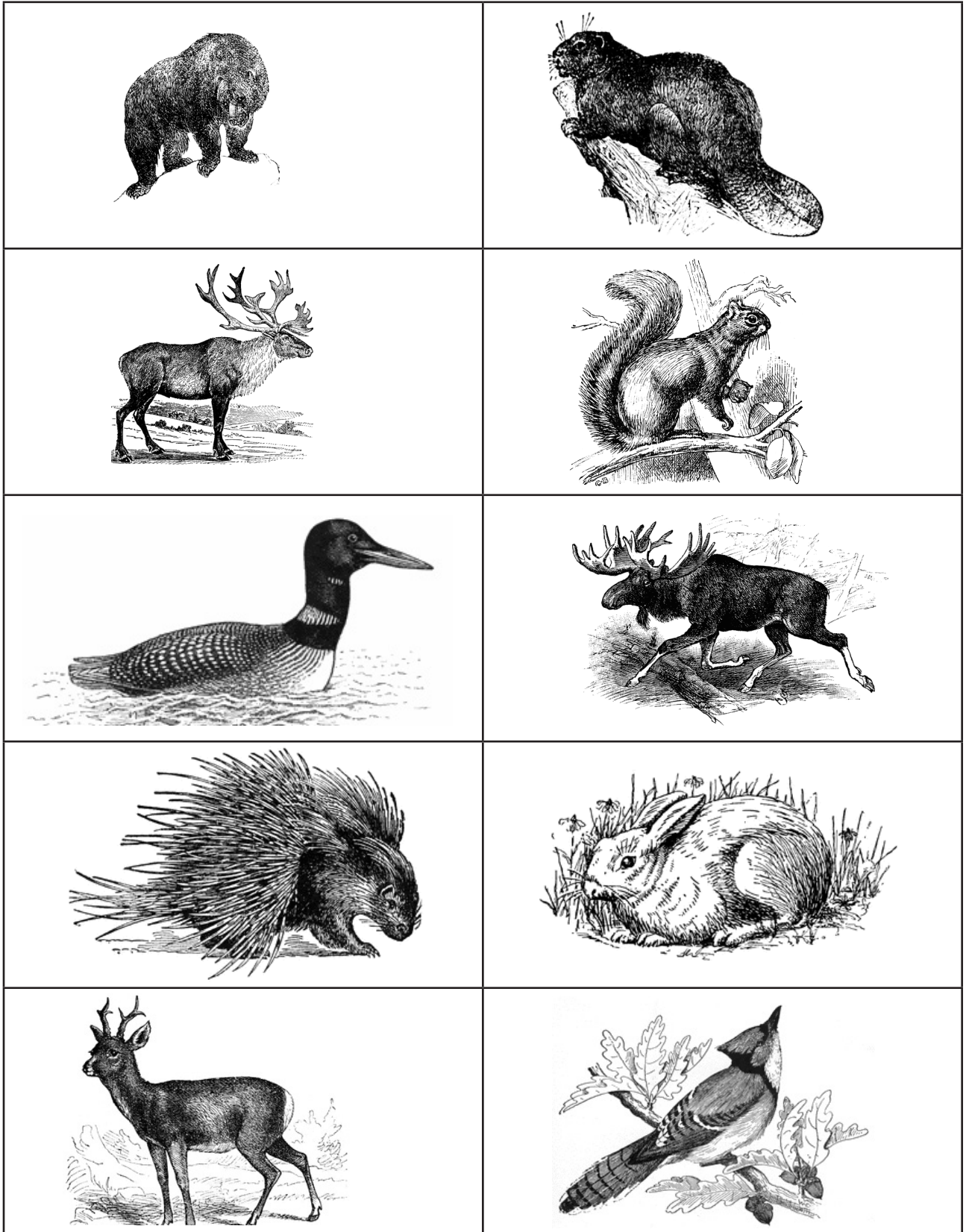

# Unit 3

## Relationships to Fresh Water

### Overview

#### *Introduction*

First Peoples view water in a holistic sense, recognizing its unique qualities and roles in the world. Water is seen in cyclical forms that mirror the Western view of the water cycle, but also include a seasonal cycle.

First Peoples have a relationship with water that acknowledges water as a unique, living entity. Bodies of water often house spirits or have a matter of personage. The relationship is viewed as an understanding of reciprocity and care. In contemporary views, many First Nations have Waterkeepers who understand and protect this relationship.

This unit examines our relationships with water from a variety of approaches. Students consider how we respect and use water at a personal level, at the local level, and from the perspectives of First Peoples. They study what makes a healthy watershed, and have the opportunity to engage in field and lab activities that analyse water quality. Finally students examine contemporary issues of water use and water quality, particularly as they affect First Peoples.

#### *Guiding Questions*

- What is our relationship with water?
- How well do we use the freshwater resources in our region?
- How can water resources be understood from the perspective of Indigenous Knowledge and Indigenous Science?
- What are some critical issues around the ways we use water?

## UNIT 3 • RELATIONSHIPS TO FRESH WATER

### Relevant BC Learning Standards for Senior Secondary Science

Course	Key Content Standards	Key Curricular Competencies
Science 10	<ul style="list-style-type: none"> <li>• Transformation of energy</li> <li>• Local and global impacts of energy transformations from technologies</li> </ul>	<p>Questioning and predicting:</p> <ul style="list-style-type: none"> <li>• Make observation aimed at identifying their own questions, including increasingly abstract ones, about the natural world.</li> </ul> <p>Planning and conducting:</p> <ul style="list-style-type: none"> <li>• Collaboratively and individually plan, select and use appropriate investigation methods, including field work and lab experiments, to collect reliable data.</li> </ul> <p>Processing and analyzing data and information:</p> <ul style="list-style-type: none"> <li>• Experience and interpret the local environment;</li> <li>• Apply First Peoples perspectives and knowledge, other ways of knowing and local knowledge as sources of information</li> </ul> <p>Evaluating:</p> <ul style="list-style-type: none"> <li>• Consider social, ethical, and environmental implications of the findings from their own and others' investigations</li> </ul> <p>Applying and innovating:</p> <ul style="list-style-type: none"> <li>• Contribute to finding solutions to problems at a local and/or global level through inquiry</li> </ul> <p>Communicating:</p> <ul style="list-style-type: none"> <li>• Express and reflect on a variety of experiences, perspectives, and worldviews through place.</li> </ul>
Earth Sciences 11	<ul style="list-style-type: none"> <li>• Water as a unique resource</li> <li>• First Peoples knowledge and perspectives of water resources and processes</li> <li>• Effects of climate change on water sources</li> </ul>	
Environmental Science 11	<ul style="list-style-type: none"> <li>• Abiotic characteristics – aquatic</li> <li>• First Peoples ways of knowing and doing</li> <li>• Resource stewardship</li> <li>• Restoration practices</li> </ul>	
Environmental Science 12	<ul style="list-style-type: none"> <li>• Water quality parameters and bioindicators</li> <li>• Availability and water use impacts</li> <li>• Land management</li> <li>• Personal choices and sustainable living</li> </ul>	
Geology 12	<ul style="list-style-type: none"> <li>• First Peoples knowledge of landforms over time</li> <li>• Groundwater and aquifers</li> </ul>	

## Resources

For further information on these resources, see the annotations in the Bibliography, beginning on page 273.

### Suggested Resources

#### Maps

- Outline map of the local community
- Topographical map of a watershed in your local area

#### Print Resources

- Assembly of First Nations. Water Declaration. <https://bit.ly/2H5rq4y>
- Safe Drinking Water Foundation, First Nation Water Issues Case Studies, linked at <https://tinyurl.com/fnesc77>.
- Saltman, Jennifer. *First Nations water ceremony held for wildfire evacuees in Kamloops*. Vancouver Sun, 2017. <https://bit.ly/2VZkHhK>
- *The Streamkeepers Handbook, A Practical Guide to Stream and Wetland Care*. Salmonid Enhancement Program, Department of Fisheries and Oceans, 1995. The Pacific Streamkeepers Federation website. <https://tinyurl.com/fnesc80>.

#### Videos

- T'souke First Nation (2013 annual water blessing ceremony). Salish Sea Sentinel, 2013. 1:28 min. <https://youtu.be/FbGEleRIYCc>
- Watershed. video and article. BC Tomorrow website (www.bctomorrow.ca). <https://tinyurl.com/fnesc58>.

#### Websites

- BC Government. Snow Survey Data. <https://bit.ly/2E7duEi>.
- BC Government. BC guidelines for water quality. <https://tinyurl.com/fnesc43>.
- British Columbia. iMapBC application BC Government website, linked at <https://tinyurl.com/fnesc28>
- Fantasy Island watershed activity <http://www.darylsience.com>, direct link at <https://tinyurl.com/fnesc16>.
- Toporama, The Atlas of Canada. Nation Resources Canada. <http://atlas.gc.ca/toporama/en/index.html>.
- Waterworks: What is a watershed at [sciencenorth.ca](http://sciencenorth.ca), link at <https://tinyurl.com/fnesc17>



### ***Additional Resources***

- Traditions and Science. Spring Culture Camp Grades 7-9 Guidebook. Old Crow Experiential Education Project. Vuntut Gwitchin Government. <https://bit.ly/2U6PXdn>
- Ts'elxwéyeqw Tribe. *Being Ts'elxwéyeqw: First Peoples' Voices and History from the Chilliwack-Fraser Valley, British Columbia*. David M. Schaepe, Ed. Harbour Publishing, 2017
- "I am the River, and the River is me: Legal personhood and emerging rights of nature." West Coast Environmental Law. <https://tinyurl.com/fnesc15>.

### ***Blackline Masters***

- 3-1 Respecting Water
- 3-2 Watershed Mapping Activity
- 3-3 Design Thinking Template
- 3-4 Case Study Framework Organizer
- 3-5 Consequence framework

### **Outline of Activities**

- 3.1 Respecting Water
- 3.2 Local Water Systems
- 3.3 Healthy Watersheds
- 3.4 Water Sampling Investigation
- 3.5 The Quality of Fresh Water
- 3.6 Contemporary Water Issues



## Suggested Activities

Note: There are more activities here than most teachers will incorporate into their units. It is not expected that you will use all of the activities, or follow the sequence as it is described. These activities are intended to be adapted to fit the needs of your students and classroom, as well as inspire ways that you can respectfully include relevant Indigenous knowledge and perspectives in your course.

### Activity 3.1 Respecting Water

---

Students consider the relationship between humans and water, the significance of water to their own lives and the natural world, and the unique relationship that First Peoples have with water.

- a. Ask students to think about their own relationship with water. You could begin by asking an open-ended question like “What is your relationship to water?” or “What are your connections with water?” Encourage a diversity of responses that reflect the many ways that we use water in our daily lives and on special occasions.
  - Students can brainstorm their responses to the question using a web or mind map, notes or diagrams.
  - After students have had time to respond, discuss the question as a whole class. Ask students to listen for the key ideas, and summarize them at the end of the discussion.
  - Ask students further questions about their relationship with water, such as:
    - Is water important to your identity? If so, how?
    - Do you take water for granted?
    - Could we show more respect for water? If so, how?
- b. Find out what you and your students know about their local domestic water systems. Ask questions such as:
  - Where does the water in our taps come from?
  - Do your families pay for the water they use? If so, how expensive is it?
  - Is your drinking water treated in any way?
  - Where does our wastewater and sewage go? How is it treated?
- c. The Interconnectedness of Water.
  - Discuss how water is interconnected with the natural world. Ask, Why is water crucial for life on Earth?
  - For more ideas and activities about the theme of Interconnectedness, see Unit 1, Interconnectedness, page 43.

 **Foundations**  
For background information about Interconnectedness, see page 15.

## UNIT 3 • RELATIONSHIPS TO FRESH WATER

 Blackline Master 3-1,  
page 103, *Respecting  
Water*

- d. First Peoples Relationships with Water.
- Students can read and discuss some quotes about the importance of water to First Peoples, found on Blackline Master 3-1, page 103, *Respecting Water*.
  - Learn some water-related words in the local First Nations language. If possible, work with First Nations language teachers in your school, district or First Nations community.
    - Water words could include: water (general term); clear water; spring or spring water; open water; lake, waterfall; water life; water spout; ocean; saltwater; to dip or draw water, to drink water, to hunt on the water, to come out of the water onto land.
    - Are there words about water that are difficult to translate into English?
  - You may want to introduce the Assembly of First Nations National Water Declaration at this point to introduce some ideas about First Peoples' relationship to water. (See Activity 3.6 below)
- e. Explore the spiritual connections First Peoples have with water. Many First Peoples hold water ceremonies. The protocols differ for each community, and have a number of purposes. However they all demonstrate the interconnectedness with water, and the respect that First Peoples hold for water.
- If possible, identify local examples of water ceremonies, or evidence of the interconnectedness of water in traditional stories.
  - The T'souke First Nations holds an annual water blessing ceremony on the ocean front. Students can watch a short video of the 2013 event. *In the water... a blessing*. T'souke First Nation. Salish Sea Sentinel, 2013. 1:28 min. <https://youtu.be/FbGElERiYcC>
  - At Kamloops in 2017, following the disastrous wildfires that summer, Secwepemc people held a special water ceremony for the evacuees who were displaced from their homes. Students can read about the ceremony in the article *First Nations water ceremony held for wildfire evacuees in Kamloops*, Jennifer Saltman, Vancouver Sun, 2017. See <https://bit.ly/2VZkHhK>.
- f. Legal Living Water. Students can investigate the topic of a body of water being declared a legal person.
- Recall, or share with students, the quote at the bottom of Blackline Master 3-1 on page 103. It reports how New Zealand has given legal rights to the Whanganui River.
  - Discuss why a river might be given the legal status of a person. Ask how this reflects the Maori relationship with the river.
  - Students can research to find out how and why this law was passed. There are a variety of places on the internet to find information. One site to start with is a BC article on the West Coast Environmental Law site, "I am the River, and the River is me: Legal personhood and emerging rights of nature," online at <https://tinyurl.com/fnesc15>.

## Activity 3.2

### Local Water Systems

Students identify local freshwater features in their community or region.

- a. How well do you know your local rivers and lakes? Discuss what streams, rivers, ponds and lakes occur around your community or region. Students can suggest water features they are familiar with, and discuss ways they may have experienced or interacted with them.
  - Ask questions such as:
    - What is the closest stream or river to our school?
    - What is the biggest river in our region? What body of water does it empty into?
  - Note that in urban areas many original streams have been buried or eliminated. Students may be interested to find out about lost streams, or projects where urban streams have been “daylighted” or opened up again.
- b. Water Walk. Take students outside to observe local water systems. There are a number of possible walks you could take.
  - If possible students could visit a nearby fresh water feature such as a lake, river or waterfall. Set a purpose that matches the feature and its significance to the local ecosystem and local First Nations communities.
  - Neighbourhood water walk. Take students around the neighbourhood to find evidence of water systems in the built environment. Ask students observe both natural water features (surface water, streams, puddles, ditches) and structures such as fire hydrants, storm drains, swimming pools, etc.)
  - How water friendly is our neighbourhood? In nature water soaks into the soil at a gradual rate. In many urban environments the ground is impermeable, increasing the amount of runoff. On your walk ask students to assess what happens to surface water in your neighbourhood. Is water allowed to percolate naturally into the soil, or is it the runoff directed to built infrastructures?
- c. Give students an opportunity to locate water features on a map of the local area. There are a variety of approaches you could use, depending on the available resources.
  - Topographical maps. If available, students can use 1:50 000 topographical maps of your region.
  - Toporama, The Atlas of Canada. This interactive website by National Resources of Canada provides topographical maps of all of Canada. <http://atlas.gc.ca/toporama>
    - You can zoom in to as small a scale as 1:6000, and any scale larger than that. There are a variety of layers that can be toggled on and off. One useful layer is water flow, which adds arrows to show the direction of



#### Formative Assessment Strategy

Provide an outline map of the community and ask students to draw on rivers, streams and lakes they know.



#### Land-Based Activity

Water Walk

## UNIT 3 • RELATIONSHIPS TO FRESH WATER

water flow for rivers. Maps can be drawn on, and both distances and areas can be measured on the map.

- Google Earth. This app provides 3-D imagery of the landscape, which students can manipulate to zoom in or look at from different perspectives. Students can find their local community on the Google Earth app and identify rivers and lakes.
- d. If the information is available and it is appropriate to share, students can learn the First Nations names of some local water features. The local Aboriginal Education department or First Nations community offices may be able to provide maps with some local place names.
- e. How does topography affect freshwater systems? Discuss the connections between the freshwater features in your region and the topography. Include standing water features such as bogs or swamps.
- f. Discuss the local water infrastructures that service your community.
- Students can find out where their drinking water comes from, and where waste water goes, and how it is treated.
  - Visit a Water Treatment Facility. You may be able to have students visit a water treatment facility to see how water is treated before they drink it. This will likely be most appropriate for First Nations communities and other small communities where the treatment plant is accessible.



### Field Trip Activity

## Activity 3.3. Healthy Watersheds

---

Students build an understanding of what a watershed is, what makes a healthy watershed, and how human activity impacts watersheds.

A watershed is a region of land that is drained by one river system. Usually it falls between ridges of high land that direct the flow of water. A watershed includes both surface water (rivers, lakes, wetlands) and subsurface ground water.

Watersheds are significant for many reasons. They collect and channel precipitation from higher ground into water systems, and ultimately into the ocean. Whatever enters the watershed affects the water quality of the whole system. They also create ecosystems. For First Peoples, watersheds support are essential for maintaining healthy ecosystems where they harvest resources. In many First Nations communities, watersheds help define boundaries for a family, clan or community resource gathering activities.

### UNIT 3 • RELATIONSHIPS TO FRESH WATER

- a. Understanding Watersheds. Ask students if they can give a definition of a watershed. If students are likely to have encountered the term before, ask them to write a definition in their own words. If not, have students suggest ideas in a class discussion.
- b. How big is a watershed? Explain that large watersheds can contain smaller watersheds. For example, the Fraser River watershed drains almost 25% of British Columbia. It is made up of several other major watersheds, such as the Nechako, Thompson and Lillooet watersheds. These in turn are made up of smaller watersheds.
- Ask students to determine what larger watersheds their community or region is part of. Suggest they consider what is the largest river the local waters flow into before entering the ocean.
- c. What is a healthy watershed? Students can view a video or read an article about watersheds in British Columbia.
- The video “Watershed” and accompanying article which covers the same content can be found at the BC Tomorrow website ([www.bctomorrow.ca](http://www.bctomorrow.ca)). The watershed page is linked at <https://tinyurl.com/fnesc58>.
  - The information includes features of a watershed, why watersheds are important, and how human activity can affect watersheds.
  - Before viewing the video, ask students to look for reasons why watersheds are important.
  - After viewing, students can work in groups to list the many ways that watershed are important. They can refer back to the video and the text.
  - Then groups can summarize the impacts of human activity on watersheds.
  - Students can use Blackline Master 2-2, page 80, *Combination Notes* to review and summarize what they have learned about watersheds.
- d. Significance of Watersheds for First Nations communities
- Students can suggest some reasons why healthy watersheds are important for First Nations communities. (For example, they are necessary for clean water, healthy ecosystems where they harvest resources; in many parts of the province they are essential for healthy salmon populations.)
  - For many BC First Nations watersheds are key to their governance systems, as watersheds are used to define their territories.
    - For an example of how watershed are used to define territories, students can refer to the Gitxsan Nation website. It has a map of Gitxsan territory that shows the lands for each Wilp or House Group.
    - The map is linked at <https://bit.ly/2PXhJpR>. This map shows the entire territories of the Gitxsan, and the individual territories of the Wilp or House Group.
    - Students can zoom in on the map to see the individual territories of all the Gitxsan House Groups. They are indicated by territory name and the chief’s name. Students can identify the watershed or part of a watershed that make up the territory of a particular House Group.



#### Formative Assessment Strategy

Assess students’ prior knowledge about watersheds through their responses and discussion.



Watershed video, BC Tomorrow website.

<https://tinyurl.com/fnesc58>



Blackline Master 2-2, page 80, *Combination Notes*

## UNIT 3 • RELATIONSHIPS TO FRESH WATER

 Blackline Master  
3-2, page 104,  
*Understanding Watersheds*

### e. Mapping watersheds

- To investigate the basics of watersheds, you can use Blackline Master 3-2, page 104, *Understanding Watersheds*. First, ask students to indicate the direction of the water flowing through the rivers and streams shown on the map.
- Next ask students to notice the dotted line marked “Saddle.” Ask what this line represents. ( E.g. the ridge between a group of hills or mountains.) Discuss the directions that the rivers on each side of this line will flow. (Above the line will flow north; below the line will flow south.)
- Ask, if rain or snow was to fall on the north side of the hill tops, where would the water eventually drain into a lake? Where would rain have to fall to drain into the large river?
- Have students identify the second saddle running north-south. They can draw a dotted line on the map to show the line of this ridge. Discuss where the rainfall would flow on either side of this ridge.
- Ask students to imagine that someone at the location labelled on the map (starburst symbol) spilled some toxic chemicals. Ask them to indicate which rivers downstream of the spill would be affected by the spill.
- Ask students to indicate the main watershed shown on this map. They could shade in the area that includes the watershed. (Students should shade all the land between the two saddles that drains into the main river.)
- Have students look back at the maps used in Activity 3.2c to identify the watershed that your school is in.
  - Have students draw a sketch map showing your local watershed, and the neighbouring watersheds.

### f. Snow Packs in Watersheds. In large watersheds, a great deal of water is stored over winter in the snowpack at higher elevations. The amount of snow, and the rate at which it melts in the spring, can have a significant impact the landscapes lower in the watershed. This can result in drought, if there was low snowfall, or in flooding, if a large pack melts quickly.

- Students can investigate the amounts of accumulated snow in a region near you and determine if the snowpack is considered to be normal or not.
  - Students can use the BC Government Snow Survey Data interactive website to find your local snow pack data station. It is found at the link <https://bit.ly/2E7duEi>.
- Once they have identified the closest data station, explore the data and determine how much snow is held in the snowpack. Compare this to another station elsewhere in the province. Compare this year to previous years.
- What are the effects and consequence of more than or less than regular amounts of snow accumulation? Ask students to think about repercussions in all four seasons.

## UNIT 3 • RELATIONSHIPS TO FRESH WATER

- Ask students to identify flooding zones in the local watershed for the upcoming spring, given what they know about watersheds and snowpack distribution.
- g. Watersheds and water cycles
- Have students build a model depicting their knowledge of, and interaction with, the water cycle considering the flow of energy. Include how the dispersal of a pollutant would affect the system.
    - Fantasy Island watershed activity at <http://www.darylscience.com>, direct link at <https://tinyurl.com/fnesc16>.
    - Waterworks: What is a watershed at [sciencenorth.ca](http://sciencenorth.ca), linked at <https://tinyurl.com/fnesc17>

### Activity 3.4

## Water Sampling Investigation

---

This activity gives suggestions for students to collect water quality data from a local stream, lake or wetland. It can be used in a variety of ways, depending on the desired purpose and outcomes.

The purpose you set for the sampling will dictate the types of tests students will undertake, and the materials you will need. See the Materials Checklist, page 97 for a list of suggested field supplies.

To organize the field trip, use Blackline Master 3-3, page 105, *Water Sampling Investigation*. You can go over the tests to be conducted, and students can fill in the appropriate boxes.

 Blackline Master 3-3,  
page 105, *Water  
Sampling Investigation*

- a. Setting the purpose for the investigation
- Decide on why students will collect the water sampling data. This will help determine which of the tests they will carry out. Some possible purposes are:
    - Salmon habitat assessment
    - Biodiversity of an ecosystem
    - Water quality for drinking
    - Is it safe for swimming?
  - You may want to have students participate in a national project to test local water quality. See the Water Rangers program, <https://waterrangers.ca>.
  - You will find a number of ideas for stream and wetland studies in *The Streamkeepers Handbook*. (DFO 1995). <https://tinyurl.com/fnesc80>.
- b. Preparations
- Discuss the purpose of the water sampling activity with the students.
    - Ask students to suggest what types of tests they might do on the water body for the purpose and outcomes they want.

## UNIT 3 • RELATIONSHIPS TO FRESH WATER

- You may want to practice collecting the water quality data in the safety of the classroom first to familiarize the students with the equipment and testing apparatus. If you know someone with an aquarium you can ask them for some of their aquarium water to get some real results.
- You could have students create maps to and from the proposed collection site.
- Students can use internet mapping resources to outline the exact data collection locations at the stream, lake or wetland.
- If time permits, you may want to visit your data collection site with your students before you start collecting data. This might help them prepare themselves for their data collection time, such as wearing the appropriate clothing and footwear or leaving some backpack items in their locker.
- You can put students into groups that are responsible for specific types of data.
- Warn students about possible dangers in stream areas from pollution and garbage that can collect from people irresponsibly disposing of garbage and waste. Also make sure they are aware that these areas are slippery and falls can occur and to wear proper footwear.

### c. Water Sampling

These are some of the principle parameters that can be collected and tested. Which ones students will use will depend on the purpose of sampling activity.

#### **Physical measurements**

Temperature: air and water

Water depth

Stream Flow Rate

#### **Chemical measurements**

pH

Nitrate

Nitrite

Ammonia

Dissolved Oxygen

#### **Observational measurements**

Turbidity test

Invertebrate identification

Streamside Plant Identification



## Water Sampling Investigation

### Field Materials Checklist

- Blackline Master 3-3 “Data Recording Sheet”
- Buckets (great for carrying your supplies)
- 2 meter stick (marked off in 1/10 meter)
- Thermometers (Celsius)
- Clipboards
- Pencils (pen ink can smear when wet)
- Aquarium Water Testing Kit (either API or Tetra brands can be bought at PetSmart or Walmart). The freshwater testing kit you get must test for pH, nitrate, nitrite, ammonia
- Salifert O2 Test kit (These are available at some aquarium stores or online in Canada for \$20)
- Stopwatch
- Calculator
- 1 to 2 foot wood stakes (tie bright flags or paint the tops of the stake a bright color)
- hammer (to drive the stakes into the stream bank)
- float for flow test. This could be a bottle filled with water (if you are certain it will be retrieved) or something biodegradable that is brightly colored that floats (e.g orange, radish)
- plastic collection containers with sealable, secure lids (can be old butter containers etc....)
- small garden hand shovel
- camera
- standard ruler
- compass
- drawing paper
- invertebrate key in plastic page protector (sample linked at <https://tinyurl.com/fnesc72>)
- clear plastic sealable bottle that is 250ml-1000ml size (for turbidity test)
- turbidity color chart in plastic page protector

## Activity 3.5

### The Quality of Fresh Water

---

This activity can be done in conjunction with Activity 3.4, Water Sampling Investigation.

- a. Have students brainstorm different ways that one or more local freshwater sources in your region, such as a lake, river or wetlands, is used.
  - Ask students to classify the uses into human or animal uses.
  - They can further classify the human uses. Ask, which are uses for local residents, and which are uses that extend beyond our region? Be sure students consider commercial, industrial, agricultural and recreational uses in addition to municipal. Human activities include:
    - Intense agriculture, which can introduce large amounts of nitrogen containing fertilizer into water systems,
    - Industrial factories, which can introduce numerous toxic contaminants through effluent discharge,
    - Urban development, which can cause stress on aquifers due to high water consumption needs of the local populations
    - Energy production, damming rivers to build hydroelectric generators can displace many of the species living in the area and completely change the location of the watershed.
  - Discuss how these different uses impact the access to water, or affect its quality.
- b. Students can engage in water sampling of local water sources. You can use both natural sources such as a local lake or stream, or a domestic supply of water such as the school water system, home, a local mall or a community centre.
  - Use the directions in Activity 3.4, selecting the tests that are appropriate for the materials you have. Typical water quality tests include:
    - alkalinity
    - ammonia
    - arsenic
    - colour
    - copper
    - iron
    - manganese
    - nitrate
    - pH
    - sulphate
    - total chlorine
    - total hardness.
  - Water testing kits can be ordered from the Safe Drinking Water

#### Lab Activity

Testing for Water Quality

## UNIT 3 • RELATIONSHIPS TO FRESH WATER

Foundation, <https://www.safewater.org>. There are opportunities for schools to be sponsored to receive the kits free, or they can be purchased.

c. How safe is your water?

- Students can refer to the BC guidelines for drinking water quality guidelines at the BC government site. Select the Drinking Water Sources guidelines linked at <https://tinyurl.com/fnesc43>.
- Students can compare their data with the guidelines to assess how well their water samples match the guidelines.
- Have students reflect on what they would do in a water quality issue in their community where the water was declared unsafe to use. Ask, Have you ever had this occur?

d. Students can use a Design Thinking activity to explore solutions for water quality issues. (Design Thinking is a framework for problem solving used in many sectors. See e.g. <https://www.ideo.com/pages/design-thinking>.)

- Pose this problem scenario:

How can a water system be regulated, monitored, purified or recycled so that people can have access to quality drinking water?

- Pair students up and have them go through the Design Thinking Template together. The template is found on Blackline Master 3-5, page 111. (2 pages). This activity may take a significant amount of time. Be sure to plan for a natural break according to your school schedule.
- Have students create a solution to the problem and present their idea. Students should include and consider both ecological and environmental impacts to their decision and how it reflects the Indigenous concepts of balance and accommodation, recognizing that all voices of those affected and all possible solutions should be included.
- Have students present their solutions to each other in a gallery walk.
- Students choose their three preferred solutions giving reasons for their choice. Students should be able to give constructive criticism on how to further improve the idea. If possible, share these ideas and solutions outside the class to obtain an authentic audience.
- Ask students to reflect on how the quality of a water source impacts the environment and people who use it. Ask questions such as:
  - How does water quality of a water source affect the body systems of those people affected?
  - How does it affect the ecosystem?
  - What links are present that would amplify the problem? (e.g. food webs, watersheds)
- As an extension, have students determine who in their community would have the power to implement these solutions. Then discuss how can these student solutions can be presented to those with the power to develop their ideas into reality?



### Peer Assessment Strategy

Have students offer constructive criticism to improve the design of others, being sure to look at scientific knowledge and quality procedures.



### Formative Assessment Strategy

Use these student reflections to assess their understanding of the impact of water quality on ecosystems and people.

## UNIT 3 • RELATIONSHIPS TO FRESH WATER

 Blackline Master  
3-5, page 113,  
*Consequence Framework*

### **Formative Assessment Strategies**

Have students submit their responses to Blackline Master 3-5, *Consequence Framework*, to assess their understanding of the importance of water quality

- e. Ask questions such as the following:
- What is happening about water safety that bothers you? Write details and examples.
  - Who is involved in this problem? Name as many people or organizations as possible.
  - How could this be different? What are alternatives?
  - What else do you want to know about this issue?
- f. Have students discuss as a small group, using Blackline Master 3-5, page 113, *Consequence Framework* with the sentence stem:
- What would be the consequences if the water was completely safe to drink...
- For example, people wouldn't need to spend money on bottled water.
  - See how far down a chain of events students can go. (For example, people would save money. People would drink tap water)

## Activity 3.6

### Contemporary Water Issues

---

- a. Whose Water Is It? This activity will help students consider their relationships to water from source to tap.
- Fill a glass or beaker of water from the tap in front of the students.
  - Set the glass down on a counter or table and ask, “Whose water is this?”
  - Let the students propose their thoughts on water ownership.
  - Refer to the water in the pipes that lead to the tap and ask the same question, “Whose water is this?”
  - Refer to a local stream or reservoir and ask the same question “Whose water is this?”
- b. As we know, water is essential to life. We also know that Canada has 1/5 of the world's freshwater supply. Yet we are also one of the highest “water wasters.” At the same time, we know that too many First Nations communities do not have quality fresh water for their daily needs.
- Discuss the issue of poor water quality that is a constant issue in some First Nations communities in Canada.
  - Have students watch a 2015 CBC news report, “Unable to drink local water for 16 years.” Found online at <https://bit.ly/2QYE9rl> (Note, contains allegations of racism)
    - Students can also read the associated news article, “Bad water: ‘Third World’ conditions on First Nations in Canada” at <https://bit.ly/2MgtKX4>.

### UNIT 3 • RELATIONSHIPS TO FRESH WATER

- c. Assembly of First Nations Water Declaration. Give students an opportunity to study the Assembly of First Nations (AFN) document, National Water Declaration.
- Present to the students the AFN National Water Declaration document and discuss how this document reflects First Nations relationships to water. Understanding that this document was written as a response to the numerous issues surrounding First Nations relationship to water, such as:
    - Degradation of water supply outside of traditional territory
    - Water as the life-blood of the earth
    - Water as a spiritual entity
- d. Compare the AFN Water Declaration with water rights in the BC Provincial Water Licensing and Rights provisions, found at the BC Government website, <https://bit.ly/2XnAEPI>
- How should conflicts about water rights between the AFN and the BC Provincial Government be resolved? For example Site C Hydroelectric Dam and pipeline construction.
- e. Bottled water. Ask students if they know of any issues around bottled water. Discuss the pros and cons of using bottled water.
- Students can research the safety and sustainability of bottled water. They can find out about places in BC where large companies are permitted to bottle water from an aquifer to sell.
  - Ask students to consider the question, Should water even be a commodity from an Indigenous perspective?
  - Have students submit their thoughts on whether water should be sold as a commodity if viewing water from a First Peoples perspective in short paragraph form.
- f. Water Issues Case Study. Have students investigate a current issue around water and consider it in light of the AFN Water Declaration.
- Discuss possible topics such as issues of water use a quality in First Nations communities, bottled water pipeline development, water or sewage treatment, impacts of climate change.
  - For additional case study examples, see a unit developed by the Safe Drinking Water Foundation, First Nation Water Issues Case Studies, linked at <https://tinyurl.com/fnesc77>.
  - This case study can be done individually, in pairs or in small groups. Use the following as a guiding question throughout the case study: “If we operate according to the AFN Water Declaration how would we respond to this issue?”
  - Students can work to gather their resources. Where necessary you may need to provide the students with some resources on their topic.



Assembly of First Nations  
National Water Declaration.  
<https://bit.ly/2H5rq4y>

### UNIT 3 • RELATIONSHIPS TO FRESH WATER

 Blackline Master 3-6,  
page 114, *Case Study  
Framework Organizer*

- Students can use Blackline Master 3-6, page 114, *Case Study Framework Organizer* to help guide their research. It lays out five criteria for the project:
  - Ability to see the issue from a First Peoples' perspective
  - First Peoples concerns are addressed in terms of the issue
  - AFN National Water Declaration document is referenced
  - First Peoples relationships to water are described in the context of the issue
  - How well does the final presentation reflect your understanding of the issue?
- Students prepare a final output that summarizes the issue and includes the criteria set out in the Case Study Framework Organizer.
- Students can present orally to teachers, as a presentation to the class, in written form or in another manner chosen by the students.

## Honouring Water

Water is the most life sustaining gift on Mother Earth and is the interconnection among all living beings. Water sustains us, flows between us, within us, and replenishes us.

Water is the blood of Mother Earth and, as such, cleanses not only herself, but all living things.

Water comes in many forms and all are needed for the health of Mother Earth and for our health.

The sacred water element teaches us that we can have great strength to transform even the tallest mountain while being soft, pliable, and flexible.

Water gives us the spiritual teaching that we too flow into the Great Ocean at the end of our life journey. Water shapes the land and gives us the great gifts of the rivers, lakes, ice, and oceans. Water is the home of many living things that contribute to the health and well-being of everything not in the water.

*Assembly of First Nations*

<https://www.afn.ca/honoring-water/>

When you respect water, that water will respect you back. If you don't respect water, that water will take you – that's when you drown."

Leo Pard, Blackfoot Spiritual Elder,  
Piikani Nation

<https://www.sacredrelationship.ca/why-water/>

When First Nations lose access to a sacred or traditional water source, they also lose access to the beings and spirits that inhabit that water source. This loss ripples out. Stories, songs, dances, and even Indigenous words related to or based in that water source are also lost. The foundational elements of Indigenous legal traditions and knowledge systems are therefore at risk.

Danika Billie Littlechild

Transformation and re-formation: First Nations and water in Canada. <https://dspace.library.uvic.ca/handle/1828/5826>

On March 20th, 2017, the New Zealand government enacted legislation recognizing the Whanganui River as a legal person, holding rights and responsibilities equivalent to a person. ... The Whanganui River legislation enshrines that pre-existing relationship [with Maori people of the river].

# Understanding Watersheds

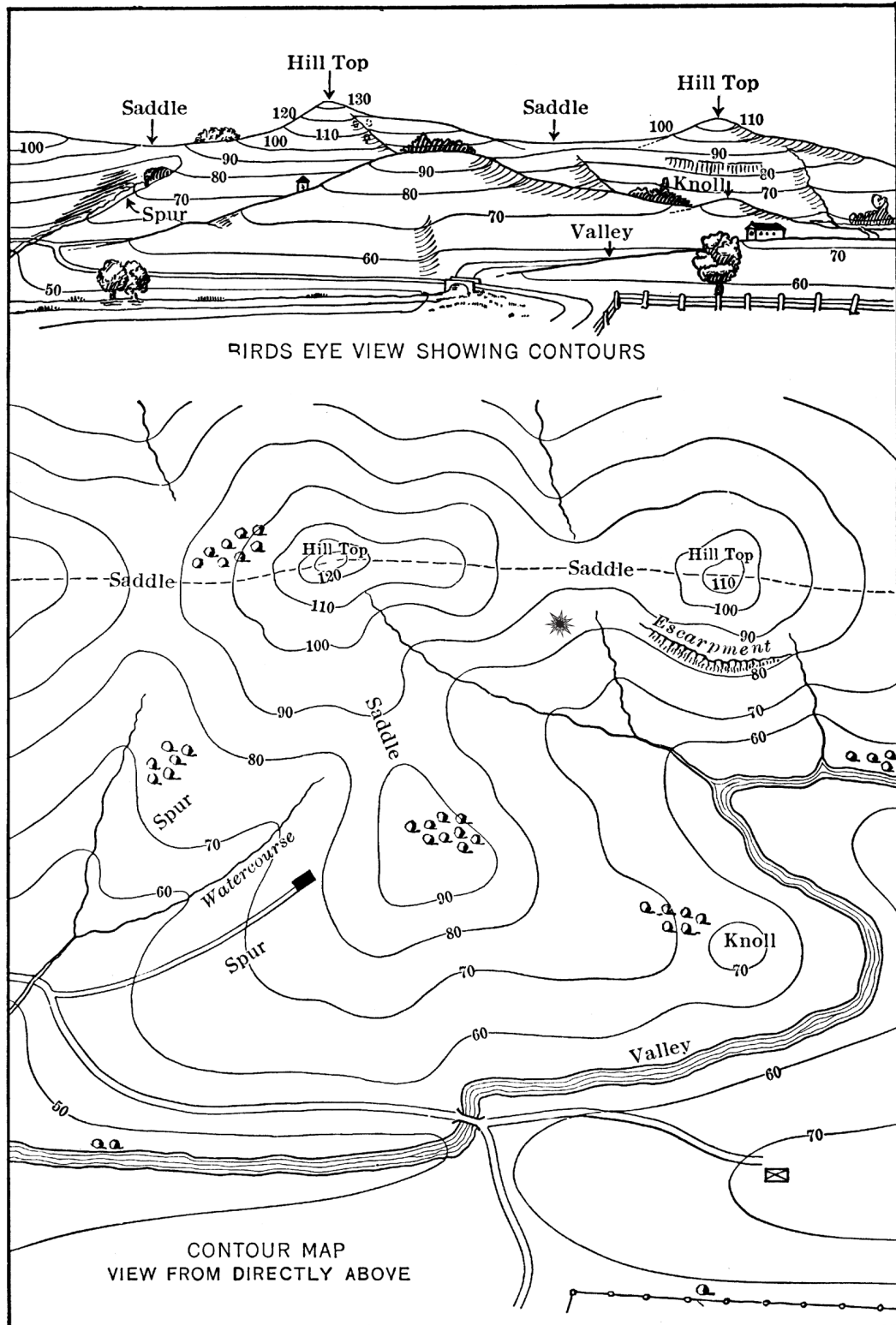



# Water Sampling Investigation

## Physical Measurements

### ☐ 1. Temperature

- Use regular lab thermometers to measure both air and water temperatures.
- Measure the water temperature in the same place and the same level where you will be taking the dissolved oxygen water sample.
- For the water temperature, put the tip of the thermometer a few centimetres below the surface.
- Wait one to two minutes before reading the temperature. Make sure you read it while it is still in the water.

### ☐ 2. Water Depth

- Use a two meter stick to measure the depth of the stream in four different spots in your sampling area.
- Record the four trials.
- Calculate the average depth.

### ☐ 3. Stream Flow Rate

#### a. Mark out a section of the stream to test

- Put a marker such as a flagged stake at the start point on a straight section of the stream.
- Measure a distance of 10m to 15m along the bank. Record the distance between stakes.
- Put another marker at the end point.

#### b. Estimate the area of the stream's cross-section

- From the start point, measure the distance across the stream from one side to the other (width).
- Take depth measurements straight across the waterway to the other side.
- Measure the depth of the stream at regular intervals using the 2 meter measuring stick.
- Add up all of the depths and divide by the number of measurements to get the Average Depth (depth).
- For a more accurate estimate you can repeat this process half way between the start and end, and at the end point.
- Calculate the area of the stream cross section using the formula  $A = w \times d$  (Area equals total width times average depth).

#### c. Run the time trials

- Release a float in the middle of the stream at the start point and start the timer. Use either a retrievable float or a biodegradable object such as a radish or orange.
- Stop timing when it reaches the end point.

- Repeat the time trial two more times.
- d. Calculate the average velocity
- Calculate the velocity of each trial using the formula  $V=d/t$  (velocity equals distance travelled divided by travel time (units of  $m^2$ ))
  - Calculate and record the average velocity.
- e. Stream Flow Rate
- Calculate the stream flow rate using the formula  $Q = A \times V$ . (Flow Rate ( $m^3/s$ ) = Total Average Cross Section ( $m^2$ ) x Surface Velocity ( $m/s$ ))
  - Since stream beds vary from rocky and rough to smooth, you have to “correct” the surface velocity to reflect the velocity on the bottom of the stream. The more rocky the bottom the lower the correction number. Choose which of these situations apply to the stream.

Type of Stream	Velocity Correction Factor
Regular channel with smooth sides	0.85
Deep slow, moving stream	0.75
A small stream with a smooth bed	0.65
A quick, turbulent stream	0.45
A very shallow, rocky stream	0.25

Flow Rate “Q” Calculation:

- The final corrected stream flow rate is  $\text{Flow Rate } (m^3/s) = \text{Total Average Cross Section } (m^2) \times \text{Surface Velocity } (m/s) \times \text{Correction factor}$

## Chemical Tests

4. pH
- Collect a water sample in the water sample bottle. Put 5 mL of the sample into a test tube.
  - Use the pH indicator from your water testing kit to measure the pH of the sample. Follow the directions for the kit to test and identify the pH.
  - Record the pH on your data sheet.
5. Dissolved Oxygen
- Collect a new sample of water. Put 5 mL of the water into a test tube.
  - Follow the instructions of the Dissolved Oxygen test kit to add the necessary test solutions, making sure you wait for the times indicated.
  - Observe the colour changes and interpret them according to the test kit instructions.
6. Nitrates
- Collect a new sample of water. Put 5 mL of the water into a test tube.
  - Follow the instructions of the nitrate test kit to add the necessary test solutions, making sure you wait for the times indicated.

- The measurements are in parts per million (ppm). You can follow your test kits instructions to measuring.
  
- 7. Nitrites
  - Collect a new sample of water. Put 5 mL of the water into a test tube.
  - Follow the directions on the nitrites test kit.
  
- 8. Ammonia
  - Collect a new sample of water. Put 5 mL of the water into a test tube.
  - Follow the directions on the ammonia test kit
  
- 9. Phosphates
  - Collect a new sample of water. Put 5 mL of the water into a test tube.
  - Follow the directions on the ammonia test kit
  
- 10. Coliform
  - Follow directions of the test kit.
  
- 11. Turbidity Test
  - Use the turbidity test as directed by your teacher.
  - You can compare your turbidity sample with the sample chart in this link:  
<https://sciencefirstpeoples.weebly.com/salmon.htm>
  
- 12. Invertebrate Identification
  - Gently disturb some of the rocks in the pools to find some of the larger invertebrates.
  - Take pictures of them, making sure to record the time and date. Make sure to leave the area as pristine as possible.
  
- 11. Plant Identification
  - Identify the plant species in and around your water quality sampling site.
  - Plants can be identified using the “E-Flora” Website at  
<https://tinyurl.com/fnesc67>

# Blackline Master 3-3

## Stream Study Data Recording Sheet

Recorder Names \_\_\_\_\_

Stream Name \_\_\_\_\_

Location \_\_\_\_\_

GPS Coordinates \_\_\_\_\_

Collection Date \_\_\_\_\_

### General Conditions

Time of Data Collection \_\_\_\_\_ am/pm

Days Since Last Data Collection \_\_\_\_\_

Weather Conditions (describe the weather as you see it...ie clear, cloudy, rainy, snowy)

\_\_\_\_\_  
\_\_\_\_\_  
\_\_\_\_\_

### Physical Measurements

Current Air Temperature \_\_\_\_\_ Co

Current Water Temperature \_\_\_\_\_ Co

Depth of Water (multiple trials across the stream)

Trial 1 \_\_\_\_\_ (m) Trial 2 \_\_\_\_\_ (m) Trial 3 \_\_\_\_\_ (m) Trial 4 \_\_\_\_\_ (m)

Average Depth \_\_\_\_\_ (m)

Distance across water \_\_\_\_\_ (m) Average Cross Section \_\_\_\_\_ (m<sup>2</sup>)

Total Average Cross Section \_\_\_\_\_ (m<sup>2</sup>)

Stream Surface Velocity (try this 3 times)

Distance in meters between the 2 flagged stakes \_\_\_\_\_ meters

Time it takes for the float to drift between the 2 flagged stakes

Trial 1 \_\_\_\_\_ seconds Trial 2 \_\_\_\_\_ seconds Trial 3 \_\_\_\_\_ seconds

Velocity (m/s) =

Trial 1 \_\_\_\_\_ m/s Trial 2 \_\_\_\_\_ m/s Trial 3 \_\_\_\_\_ m/s

Velocity Average \_\_\_\_\_ m/s

## Stream Study Data Recording Sheet page 2

### Chemical Measurements

pH \_\_\_\_\_ (1 – 14) Nitrite Test \_\_\_\_\_ 0 – 5 ppm (mg/L)

Nitrate Test \_\_\_\_\_ 0 – 160 ppm (mg/L) Ammonia Test \_\_\_\_\_ 0 – 8.0 ppm (mg/L)

Dissolved Oxygen \_\_\_\_\_ 2 – 14 ppm (mg/L)

### Observational Measurements

Water Turbidity \_\_\_\_\_ 10 – 250 (NTU)

### Invertebrate & Plant Identification

(these might be identified at a later time from pictures)

Record the date and time of each picture taken

Photo 1 Date/Time \_\_\_\_\_ Identification \_\_\_\_\_

Photo 2 Date/Time \_\_\_\_\_ Identification \_\_\_\_\_

Photo 3 Date/Time \_\_\_\_\_ Identification \_\_\_\_\_

Photo 4 Date/Time \_\_\_\_\_ Identification \_\_\_\_\_

Photo 5 Date/Time \_\_\_\_\_ Identification \_\_\_\_\_

Photo 6 Date/Time \_\_\_\_\_ Identification \_\_\_\_\_

Photo 7 Date/Time \_\_\_\_\_ Identification \_\_\_\_\_

Photo 8 Date/Time \_\_\_\_\_ Identification \_\_\_\_\_

Photo 9 Date/Time \_\_\_\_\_ Identification \_\_\_\_\_

### Streamside Plant Identification

Draw an aerial sketch of where the plants occur in relation to the stream on the next page.

Add the following features where they occur in your sampling location

Log

Riffles

Rapids

Overhanging bank or cutback

Rocks along a shoreline

Garbage or Refuse

# Stream Study Data Recording Sheet page 3

## Streamside Plant Identification

(Draw an aerial sketch of where the plants occur in relation to the stream)

Write the names of the species in the place(s) where they occur

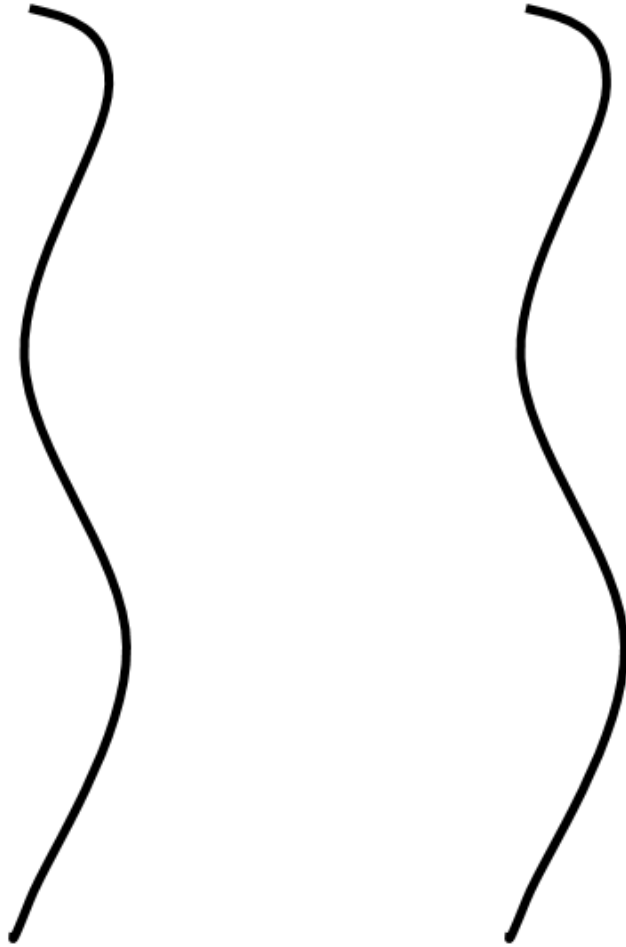

Add the following features where they occur in your sampling location



Overhanging bank or cutback along a shoreline





## Design Thinking Template

4. Sketch 5 Ideas (Ideate)

5. Gain Feedback from Your Partners (Ideate)

6. Redesign Your Idea Based on Feedback (Ideate/Prototype)

7. Sketch Your Group's Idea (Ideate/Prototype)



# Consequence Framework

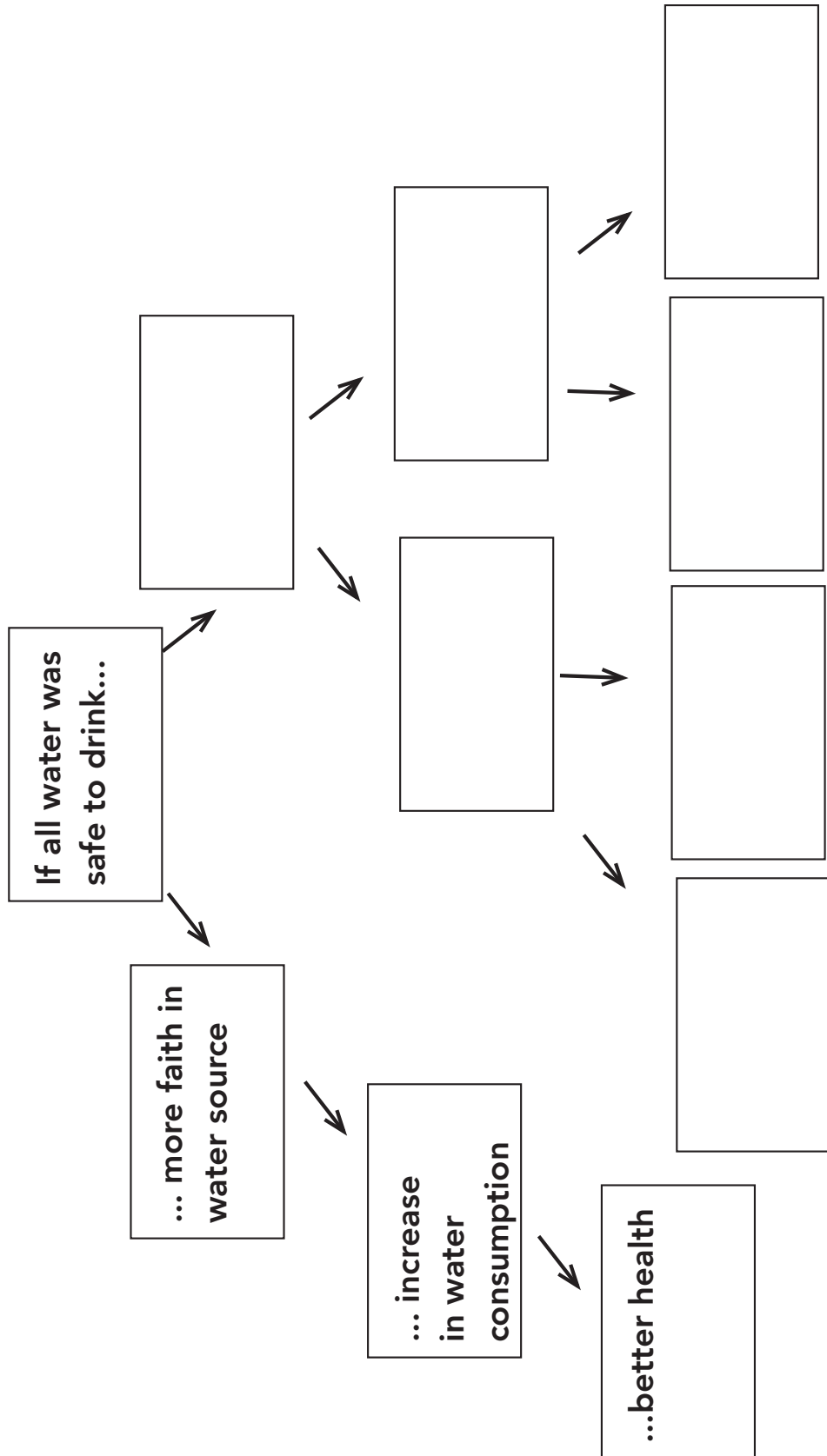

## Blackline Master 3-6

# Case Study Framework Organizer

As you look into an issue presented by your teacher, consider the following aspects of the issue and record your thoughts.

- Ability to see the issue from a First Peoples' perspective
- First Peoples concerns are addressed in terms of the issue
- AFN National Water Declaration document is referenced
- First Peoples relationships to water are described in the context of the issue
- How well does the final presentation reflect your understanding of the issue?

Prepare a final output that summarizes the issue and includes the parameters set out in the grading rubric below.

You can present orally to your teacher, make a presentation to the class, in written form or in another format agreed on by you and your teacher.

	4	3	2	1
Ability to see the issue from a First Peoples perspective	All aspects of the issue were discussed using First Peoples viewpoints	Most aspects of the issue were discussed using First Peoples viewpoints	Few aspects of the issue were discussed using First Peoples viewpoints	No attempt was made to view the issue through First Peoples perspectives
First Peoples concerns are addressed in terms of the issue	All possible concerns are addressed in terms of the issue.	Multiple concerns are addressed in terms of the issue.	One concern is addressed in terms of the issue.	No First Peoples concerns are addressed in terms of the issue.
AFN National Water Declaration document is referenced	AFN National Water Declaration document is referenced where appropriate	AFN National Water Declaration document is referenced, in some cases inappropriately.	AFN National Water Declaration document is referenced inappropriately	No reference to AFN National Water Declaration document
First Peoples relationships to water are described in the context of the issue	First Peoples relationship to water is interwoven throughout the discussion	First Peoples relationship to water is part of the discussion	First Peoples relationship to water is briefly referenced	First Peoples relationship to water is not present in the response to the issue.
To what extent does the final presentation reflect your understanding of the issue?	The final presentation clearly reflects the students research and clearly shows understanding	The final presentation at times reflects the students research and understanding is generally shown	The final presentation rarely reflects the student research and rarely is understanding shown	The final presentation does not reflect the student research and understanding is not shown.

# Unit 4

## Shaping the Land

### Overview

Traditional Ecological Knowledge incorporates many ways of taking care of the land to ensure that resources are sustainable and provide food security for the present and the future. Today we may use terms such as land management, stewardship, and conservation, but for First Peoples the application of traditional knowledge was and is a way of life.

First Peoples applied knowledge to take care of the land and resources in diverse ways. For example, they used selective harvesting to ensure plants and animals were only harvested at appropriate times, taking into account the time of year, the age or point in the organism's life cycle. People rotated their harvest sites so that the plants and animals were not depleted in one area. In order to regulate the management of the resources, First Peoples had systems in place to control and regulate who could use what territories.

Another way that First Peoples managed the land in the past was to actively shape the land. They used a diversity of practices that maintained, enhanced and intensified the resources. These include terracing the ground to produce clam gardens and root gardens, building structures to direct the movement of fish and animals, and using controlled burning to maintain ecosystems.

In this unit students will have an opportunity to learn about a variety of ways that First Peoples shaped the land in the past, and infer the Traditional Ecological Knowledge and understanding of scientific principles that were used in these techniques. They also can engage in activities that look at ways that these ancient practices can be applied today.

### *Guiding Questions*

- How have First Peoples practices affected the sustainability of ecosystems?
- How have First Peoples applied their knowledge of the land to alter landscapes in ways that ensure a sustainable lifestyle?
- How do traditional practices for shaping the land encourage growth and sustainability of the local culture?
- In what ways can traditional First Nations strategies and practices be applied today?

## Relevant BC Learning Standards for Senior Secondary Science

Course	Key Content Standards	Key Curricular Competencies
Environmental Science 11	<ul style="list-style-type: none"> <li>• Ecosystem complexity: roles; relationships; population dynamics</li> <li>• Energy flow through ecosystems</li> <li>• Matter cycles through and between living systems</li> <li>• Succession</li> <li>• First Peoples knowledge and other traditional ecological knowledge in sustaining biodiversity</li> <li>• Benefits of ecosystem services</li> <li>• Human actions and their impact on ecosystem integrity</li> <li>• First Peoples ways of knowing and doing</li> <li>• Resource stewardship</li> <li>• Restoration practices</li> </ul>	<p>Questioning and predicting</p> <ul style="list-style-type: none"> <li>• Make observation aimed at identifying their own questions, including increasingly abstract ones, about the natural world.</li> </ul> <p>Planning and conducting</p> <ul style="list-style-type: none"> <li>• Collaboratively and individually plan, select and use appropriate investigation methods, including field work and lab experiments, to collect reliable data.</li> </ul> <p>Processing and analyzing data and information</p> <ul style="list-style-type: none"> <li>• Experience and interpret the local environment</li> <li>• Apply First Peoples perspectives and knowledge, other ways of knowing and local knowledge as sources of information</li> </ul>
Environmental Science 12	<ul style="list-style-type: none"> <li>• Soil characteristics and ecosystem services</li> <li>• Land use and degradation</li> <li>• Land management</li> <li>• Personal choices and sustainable living</li> <li>• Global environmental ethics, policies and law [<i>including First Peoples perspectives, philosophies and responsibilities</i>]</li> </ul>	<p>Evaluating</p> <ul style="list-style-type: none"> <li>• Consider social, ethical, and environmental implications of the findings from their own and others' investigations</li> </ul> <p>Applying and innovating</p> <ul style="list-style-type: none"> <li>• Contribute to finding solutions to problems at a local and/or global level through inquiry</li> </ul> <p>Communicating</p> <ul style="list-style-type: none"> <li>• Express and reflect on a variety of experiences, perspectives, and worldviews thorough place.</li> </ul>

### *Cross-curricular Connections*

BC First Peoples 12

- Traditional Territories of the BC First Nations and relationships with the land

Contemporary Indigenous Studies 12

- Varied identities and worldviews of indigenous peoples, and the importance of the interconnection of family, relationships, language, culture, and the land

## Resources

For further information on these resources, see the annotations in the Bibliography, beginning on page 273.

### Suggested Resources

- Ethnobiology books and articles, particularly those relating to the local area
- Access to a field site (see Activity 4.6)
- Snively, Gloria and Wanosts'a7 Lorna Williams, eds. *Knowing Home: Braiding Indigenous Science with Western Science, Book 1*. Download at <https://pressbooks.bccampus.ca/knowinghome>

Resources for studying Clam Gardens

- "Ancient Clam Gardens Increased Shellfish Production: Adaptive Strategies from the Past Can Inform Food Security Today." Amy S. Groesbeck, Kirsten Rowell and Dana Lepofsky, Anne K. Salomon. *PLoS ONE* 9(3), 2014. Linked at <http://ow.ly/NJ1L303qvDU>
- The Clam Garden Network. Website at <https://clamgarden.com/>.
- *Clam garden time lapse*. <https://youtu.be/hqWC5CeVQy8>
- *Mysteries of Ancient Clam Gardens*. Andrew Elizaga, 2013. 6:43 min. [https://youtu.be/DIGn4yd15\\_I](https://youtu.be/DIGn4yd15_I)
- *A Wall Worth Building*. 3:55. Hakai Magazine, 2017. <https://youtu.be/22Nytmxw2Z8>
- Williams, Judith. *Clam Gardens*. New Star Books, Vancouver, 2006.

Resources for studying Shell Middens

- Shell Middens. (1 page summary) Royal BC Museum website: <https://tinyurl.com/fnesc22>
- Ancient First Nations Archaeology Midden Site. (2.10 min video) [https://youtu.be/yDAL2fo\\_AjA](https://youtu.be/yDAL2fo_AjA)
- Shell Midden. (2.14 min. video) History channel. <https://youtu.be/Z7mOuWnzk1o>
- Shell Middens. (article) The Canadian Encyclopedia. <https://tinyurl.com/fnesc23>.
- Gamble, Jessa. "How British Columbia's Coastal People Fertilized the Forest." *hakaimagazine.com*, linked at <https://tinyurl.com/fnesc24>.
- Trant, Andrew J. *et al.* "Intertidal Resource Use Over Millennia Enhances Forest Productivity. *Nature Communications* 7, 2016. Linked at <https://tinyurl.com/fnesc25>.

Resources for studying Landscape Burning.

- CBC. *Imagine the Fire*. *The National*. 2013. 14:24 min. <https://bit.ly/2UC2u87>.

## UNIT 4 • SHAPING THE LAND

- CBC “B.C. First Nation sets fires to save bison,” <https://tinyurl.com/fnesc26>.
- Indigenous Corporate Training Inc. “Indigenous Fire Management and Traditional Knowledge.” 2019. <https://bit.ly/2UTXhgU>.
- Johnson, Leslie Main. “Aboriginal Burning for Vegetation Management in Northwest British Columbia.” In *Indians, Fire and the Land in the Pacific Northwest*. Robert Boyd, ed. Oregon State University Press, 1999. Linked at <https://tinyurl.com/fnesc27>.
- Simmons, Ellen. “British Columbia’s Indigenous People: The Burning Issue.” *Journal of Ecosystems & Management* 13 (2). <https://bit.ly/2L1aBLT>

### Additional Resources

- Deur, Douglas and Nancy Turner, eds. *Keeping It Living: Traditions of Plant Use and Cultivation on Northwest Coast of North America*. University of Washington Press, 2006.
- Turner, Nancy and Fikret Berkes. *Coming to Understanding: Developing Conservation through Incremental Learning in the Pacific Northwest*, 2006. *Human Ecology* v. 34. Online at <https://bit.ly/2H9U9FD>.
- FNESEC. *Science First Peoples Teacher Resource Guide Grades 5 to 9*. FNESEC/FNSA, 2016.

### Blackline Masters

- 4-1 Shaping the Land
- 4-2 Clam Gardens
- 4-3 Stone Fish Traps

### Outline of Activities

- 4-1. First Peoples Relationships with the Land
- 4-2. How Did First Peoples Shape the Land in the Past?
- 4-3. Clam Gardens; Shaping the Intertidal Zone
- 4.4 Indigenous Landscape Burning
- 4.5 Modifying Waterways
- 4.6 Can Ancient Methods Work Today?

## Suggested Activities

Note: There are more activities here than most teachers will incorporate into their units. It is not expected that you will use all of the activities, or follow the sequence as it is described. These activities are intended to be adapted to fit the needs of your students and classroom, as well as inspire ways that you can respectfully include relevant Indigenous knowledge and perspectives in your course.

### Activity 4.1

#### First Peoples Relationships with the Land

Build on students' understanding of First Peoples' reciprocal relationships with the land.

- a. Ask students to reflect on the question, "Why is the Land important to First Peoples?"
  - Students can record their own thoughts, then share with a partner or the class.
  - Alternatively, students could work in groups to brainstorm a number of reasons why the land is important.
- b. If you have not done so, use activities from Unit 1, 1-2, Reciprocal Relationships With the Land on page 40. If you have, review why a reciprocal relationship is important for First Peoples' relationships with the land.
- c. To build students' understanding of the traditional territories of the local First Nations, see *Science First Peoples 5-9*, for the activity "Traditional Territories," page 34.



#### Formative Assessment Strategy

Use student responses to this question to assess their understanding of First Peoples' relationships with the land.

**Science First Peoples 5-9**  
Traditional Territories, page 34

### Activity 4.2

#### How Did First Peoples Shape the Land in the Past?

- a. Discuss with students different ways that people modify the land today. (For example, we clear it to build houses and roads, we cut down trees for wood, we build dams to produce electricity.) Ask, which of these examples demonstrate a reciprocal relationship with the land?
  - Landscape Walk. Students can explore their neighbourhood or community to observe how the landscape has changed over time. Ask them to picture how it might have looked fifty years ago or 200 years ago.
    - Students can take pictures that show how the local landscape has been changed over time.



Land-Based Activity

Landscape Walk

## UNIT 4 • SHAPING THE LAND

- Later they can share their images with the class and discuss why they chose to photograph the subjects they did.
  - Alternatively, they can find pictures in publications or online that show how people have altered the landscape in striking or significant ways around the world.
  - Discuss the question, Is there a reciprocal relationship shown in the photographs, and if so, what are the consequences?
- b. Ask students if they know of any ways that First Peoples modified or shaped the land in the past. Write their suggestions on the board. If students can't think of any ways, ask them to predict how First Peoples might have shaped the land in the past.
- Discuss how these methods might be different or similar to the modern ways people alter landscapes today.
  - Discuss how the examples or predictions could demonstrate reciprocal relationships. For example, some techniques enhance the productivity of the land, giving back – it needs to be sustained.
- c. To spark interest, present an example of one of the examples of land modified by First Peoples in the past. If possible, illustrate a local example.
- It could be an example that:
    - will be of special interest to your students
    - is relevant to the local First Nations
    - is relevant to current events, such as landscape burning in relation to wildfires
  - Use one of the examples discussed in the activities below. Some suggestions are:
    - landscape burning
    - wapato garden
    - clam garden
    - reef net fishery
    - stone or wooden fish traps
- d. Students can use Blackline Master 4-1, page 130, *Shaping the Land*, to learn about some of the ways that people modified or shaped the land in the past. Students are asked to suggest what they think the purpose of shaping the landscape might have been for each example.
- e. Students choose one of the methods to investigate further. This could be done as an inquiry, or as research project.
- Inquiry: Students could create an inquiry question about one of the methods that interests them. They would then research the topic to find answers to their question.
  - Alternately, students could research one of the techniques and present their findings as a project.

 Blackline Master 4-1,  
page 130, *Shaping the  
Land*,

### Formative Assessment Strategies

As students work on their projects, assess the connections they are making between skills and processes involved with the technique, and the big ideas of survival, sustainability and reciprocity.



## UNIT 4 • SHAPING THE LAND

- Discuss different aspects of the techniques that can be investigated, including:
    - underlying traditional scientific knowledge required
    - technologies required
    - skills required
    - purpose or goals of the technique
    - connections with other cultural aspects
    - the reciprocal nature of the technique
    - ways that the practice or strategy aided sustainability or survival
    - real-life examples of where this technique was or is used.
  - Refer to the activities below for suggestions for resources.
  - Students can use the 7 Es to guide the research. Students can use Blackline Master 5-4, page 158 (Unit 5) Inquiry Using the 7 Es. For background see 7 E Model in Foundations, page 31.
- f. Have students decide how they will present their findings. For example, they could create a written report with illustrations, a model with explanatory notes, a digital slide show or video, or an oral talk.
- g. After students have completed their inquiries and projects, they can present them to the class or to another audience such as an Elders or Seniors group in the community.

 Blackline Master 5-4, page 158 (Unit 5) Inquiry Using the 7 Es.

 **Foundations**  
7 Es Model, page 31

 **Self-Assessment Strategy**  
Have students assess their final product using criteria established by the class.

### Activity 4.3

## Clam Gardens: Shaping the Intertidal Zone

Students can take a closer look at one way that First Peoples on the coast altered the land to enhance the yield of resources. Clam gardens were used on the coast for millennia to enhance clam growing ecosystems. After colonization they fell into disuse, and only around 2006 were they widely noticed and studied by the outside world.

- a. Introduce the topic of clam gardens using the video *A Wall Worth Building*, produced by Hakai Magazine, found online at <https://youtu.be/22Nytmxw2Z8>
- Student could view other videos to get different perspectives on clam gardens. For example:
    - Mysteries of Ancient Clam Gardens. This can be found on Youtube at [https://youtu.be/DIGn4yd15\\_I](https://youtu.be/DIGn4yd15_I).
    - For a short view of a clam garden through the changing tides, view the time lapse video found at <https://youtu.be/hqWC5CeVQy8>
- c. Students can research more about clam gardens to investigate the Indigenous scientific understandings inherent in their structure. They can find out how the clam gardens require a knowledge of habitat interconnectedness.

## UNIT 4 • SHAPING THE LAND



### Clam Garden Model

- Explore the structure of the clam garden and suggest the benefit they served for both the natural environment and for the First Nations that used them. Ask, how does the clam garden structure change to suit the needs of the local environment?
- Research sources include:
  - Blackline Master 4-5, Clam Gardens, page 132.
  - *Clam Gardens*, by Judith Williams.
  - The Clam Garden Network. Website available at clamgarden.com
  - A report on a scientific study is available online: Ancient Clam Gardens Increased Shellfish Production: Adaptive Strategies from the Past Can Inform Food Security Today. Linked at <http://ow.ly/NJ1L303qvDU>.
- d. Students can illustrate a clam garden, or build a model or diorama of a beach with a clam garden.
  - Students can work in groups to create dioramas of a clam bed. They could use clay, sticks, sand, grass and clam shells to put together a representation of aquaculture structures built by indigenous peoples.
- e. Explain that the technology of clam gardens wasn't widely known outside of First Nations communities until 2006. Discuss why such a significant resource management technology was virtually unknown by science for so long.
- f. Coastal Shell Middens. The large quantities of shellfish harvested in the past resulted in the alteration of the land in a different way. People deposited the shells around their houses, and eventually the shells formed huge piles around the habitation site. People used the shells to level out the ground, or build up the terrain. Today the middens are important archeological sites, and are evidence of the presence of First Nations living there for thousands of years.
  - Students can find out what a shell midden is, and how their composition largely of shells has enabled them to last for thousands of years.
  - Suggested resources include:
    - Shell Middens. (1 page summary) Royal BC Museum website: <https://tinyurl.com/fnesc22>
    - Ancient First Nations Archaeology Midden Site. (2.10 min video) [https://youtu.be/yDAL2fo\\_AjA](https://youtu.be/yDAL2fo_AjA)
    - Shell Midden.(2.14 min. video) History channel. <https://youtu.be/Z7mOuWnzk1o>
    - Shell Middens. (article) The Canadian Encyclopedia. <https://tinyurl.com/fnesc23>.
  - Student can investigate a feature of shell middens only recently recognized by scientists. Researchers have found that trees, particularly western red cedar, grow better in the presence of shell middens.
    - Students can learn more by reading the article “How British Columbia’s Coastal People Fertilized the Forest,” at the website hakaimagazine.com, linked at <https://tinyurl.com/fnesc24>.

## UNIT 4 • SHAPING THE LAND

- The study this article is based on is “Intertidal Resource Use Over Millennia Enhances Forest Productivity: Trant *et al.*, at the website nature.com, linked at <https://tinyurl.com/fnesc25>.
- g. Students can conduct soil tests to measure the calcium content.
  - Students can use a simple test with vinegar. For a suggested procedure to follow, see the activity Determination of Carbonate Concentrations in Calcareous Soils with Common Vinegar Test, online at <https://bit.ly/2VnI2sz>.
  - Students can use chemical indicators to conduct further soil tests.
  - Have students design an experiment that studies the effects of adding shells to soil. If possible, have them carry out their experiment.
  - Students could possibly investigate areas where Indigenous clam gardens may have been cultivated to see if the concentration of calcium is higher than other areas. This confirmation can lead to conversations and discussion about the benefits of previous land shaping by Indigenous peoples.
- h. Have students summarize what they have learned about clam gardens.
  - Students can label or be able to explain orally ways that the clam garden illustrates Traditional Ecological Knowledge.



### Lab Activity

Soil tests for Calcium



### Formative Assessment Strategy

Students should label or be able to explain orally ways that the clam garden illustrates Traditional Ecological Knowledge.

## Activity 4.4 Indigenous Landscape Burning

---

In this activity, students will better understand how fire was used for thousands of years as a practice by First Peoples in stewardship of the land (for restoration, community protection and food security).

- a. Introduce the technique of controlled landscape burning by having students view the CBC video *Imagine the Fire*. It reports on how the Dene of the Fort Liard First Nations in north-eastern BC use traditional burning practices to manage its traditional territories.
  - CBC. *Imagine the Fire*. *The National*. 2013. 14:24 min. <https://bit.ly/2UC2u87>. CBC news video
  - Students can also read the accompanying news article “B.C. First Nation sets fires to save bison” linked at <https://tinyurl.com/fnesc26>.
  - For further background, students can read the article “British Columbia’s Indigenous People: The Burning Issue.” by Ellen Simmons. *Journal of Ecosystems & Management* 13 (2). <https://bit.ly/2L1aBLT>

## UNIT 4 • SHAPING THE LAND

- b. Ask students to think about why First Peoples used fire to manage the land in the past.
- First ask students to predict why First Peoples might want to use controlled burning on their territories. Ask them to think of a variety of ways it might be used.
  - To see a summary of ways that fire was used in the past, students can read the article “Indigenous Fire Management and Traditional Knowledge.” (Indigenous Corporate Training Inc. 2019) <https://bit.ly/2UTXhgU>.
  - The uses of controlled or prescribed burning given in the article are to:
    - Manage the buildup of combustible materials
    - Manage regeneration
    - Manage pests
    - Open and maintain trails and paths
    - Create grazing lands for prey species (and later for horses)
    - Rejuvenate quality and quantity of forage (new growth being higher in protein and minerals)
    - Clear land for agriculture
    - Stimulate productivity of berry patches
    - Stimulate growth of medicinal plants
    - Produce materials for basketry
    - Create fuel breaks around camps and villages
  - Have students think more about the ways that First Peoples used fire to manage the land.
    - Students can work in groups to consider one of the uses, distributed so all the uses are covered. They can explain what the given use means, and suggest what the expected results of the burning would look like. When completed they can share their findings with the rest of the class.
    - Students can illustrate one of the uses of fire. The illustrations can be displayed in a gallery.
    - Charades. To engage students actively, have them select one of the uses and act it out for group members or the whole class, who will try to determine which use it is. The selection could be their own choice, or you could write the items on slips of paper which students select at random.
- c. Students can dig deeper into the use of Indigenous fire management by reading an ethnobotany study about landscape burning in one region of BC.
- "Aboriginal Burning for Vegetation Management in Northwest British Columbia," by Leslie Main Johnson. (1999) Available for download at <https://tinyurl.com/fnesc27>.
  - Note that, consistent with the time this was written, the term "Indian" is used in the document.
  - This study explores the use of landscape burning by the Gitksan and We'suwe'ten people of the upper Skeena River region.

## UNIT 4 • SHAPING THE LAND

- Have students read to find out how the Gitksan and We'suwe'ten used fire to manage the landscape. Ask questions such as:
    - Where did they burn?
    - When did the burn?
    - Why did they burn?
    - Who was responsible for the burning?
    - What effect did the appropriate burning have on the vegetation?
    - What skill and knowledge did people use to burn successfully?
  - Ask students to read the section Suppression of Berry Patch Burning, pages 244-245. Discuss why the provincial government suppressed the traditional burning practices.
- d. Have students suggest the skills, understanding of scientific principles and traditional ecological knowledge First People needed for landscape burning.
- Responses could include:
    - knowledge of the weather; understanding the right wind and precipitation conditions to start burning
    - understanding fuel loads; the amount of vegetation that there is to burn
    - how to control the burning so it doesn't run away
    - understanding how plants and soil will respond to the burning
    - knowledge of plant cycles and how they will regenerate
    - how frequently burning should take place (e.g. every two years, ten years?)
- e. Landscape Burning Lab Demonstration. As a class project, have students compare the growth potential of burned sod and unburned sod.
- Necessary items are:
    - 2 metal pie pans
    - 2 “pie pan sized” pieces of sod (maybe from a corner of your sports field).
  - Let both pieces of sod dry out for 10 days.
  - In either a fume hood or outdoors in a location such as the school parking lot, burn the dried grass on one of the pieces of sod in its pie pan.
  - After the piece of sod has cooled, plant seeds from another type of plant not growing in the sample. Apply an appropriate amount of water in both the burned and the unburned soil samples.
  - Allow the plants to grow. Compare the subsequent growth of the secondary growth plants in both of the samples.
- f. Wildfires. Effects of climate change can be witnessed in the increasing number of wildfires we experience in BC and elsewhere. Some people believe if traditional landscape burning practices were followed, there would less threat of such large forest fires. Students can investigate the issue to decide if they agree or disagree.
- Students can work in pairs or small groups to examine the issue. Groups can create their own questions to investigate, or the class could decide on a question. For example, they could ask, “How would traditional landscape burning practices affect the forest fire situation today?”



### Lab Activity

Landscape Burning  
This lab activity has been tested and works successfully and safely.

## Activity 4.5

### Modifying Waterways

---

Many Indigenous techniques for shaping the land involve terrestrial ecosystems. However, they also used sophisticated technologies to enhance aquatic ecosystems. These include wetlands, estuaries and marine environments. Clam gardens are one example, and a number of other examples are given here.

Students can explore one or more of these technologies on their own or in groups. They could conduct a research project or an inquiry-based study. This should include an analysis of the Indigenous knowledge and understanding of scientific principles (e.g. biological, physical) that were (and are) applied to use the technology successfully.

The topics below give a brief overview and a number of resources that students can begin with.

#### a. Wapato Gardens

Wapato is an aquatic plant that grows in wetlands. In the past they were a significant source of carbohydrates for some First Nations communities, including the Katzie First Nation in the Pitt River area. Recent road construction in the area revealed a complex management system that shows people enhanced the wetland habitat to increase the sustainability of the plant.

Students can investigate how First Nations modified the wetlands thousands of years ago, and how the Katzie First Nation is working to restore their habitat today.

- This is an online news article summarizing the finding of the wapato gardens. "Hunting the Elusive Wapato," Joanne Will, 14 Jan 2010, The Tye, linked at <https://tinyurl.com/fnesc62>.
- "Engineered feature used to enhance gardening at a 3800-year-old site on the Pacific Northwest Coast." Tanja Hoffmann et al. *Science Advances*, 2016. Linked at <https://tinyurl.com/fnesc61>.
- Katzie & the Wapato: An Archaeological Love Story. Natasha Lyons, et al. *Archaeologies: Journal of the World Archaeological Congress*, 2018. Download at <https://tinyurl.com/fnesc59>.
  - This article is notable because it presents a scientific study as a narrative.
- *This is an Eco-Cultural Restoration in Katzie Traditional Territory*. Katzie First Nation, linked at <https://tinyurl.com/fnesc60>.

#### b. Reef Net Fisheries

This unique technology was used by Straits Salish communities around southern Vancouver Island and the Gulf Islands. It involves using stationary nets to mimic the ocean floor and make the fish think they are heading for deeper water.

## UNIT 4 • SHAPING THE LAND

- Video: *To Fish As Formerly: WSÁNEĆ Nation Brings Reef Net Fishing Back After 100 Years* (5.35 min.) <https://youtu.be/vTQk1IR9ibc>
- Ahearne, Suzanne. "Reclaiming a Banned Saanich Fishery." UVic News, 2016. <https://tinyurl.com/fnesc29>.
- Claxton, Earl and John Elliot Sr. *Reef Net Technology of the Saltwater People*. Saanich Indian School Board, 1994.
- Reef net fishing is used as a case study in the article "Coming to Understanding: Developing Conservation through Incremental Learning in the Pacific Northwest" by Turner and Berkes See pages 506 (last paragraph) to page 510 of Turner and Berkes. <https://bit.ly/2H9U9FD>
- *Knowing Home*, pages 122-123 discuss this fishery, with an illustration.

### c. Estuary Gardens

In a similar fashion to clam gardens, First Peoples built terraces along estuaries to increase the critical habitat for some important food plants that grow in particular zones of estuaries. These are sometimes called root gardens, or estuarine root gardens.

- See pages 125-127 of *Knowing Home*, Book 1. This includes pictures of some of the plants grown in estuary gardens, and diagrams of a cross-section of a salt marsh.
- Students can investigate an ethnobotanical project conducted in Squamish territory, led by Indigenous ethnobotanist Leigh Joseph.
  - Students can read the online article "Getting Back to Her Roots (Nicole Trigg, *The Squamish Chief* June 24, 2011) <https://bit.ly/2UACM4w>. This article explains how Leigh Joseph studied the rice root plant for her Master's thesis, and involved the Squamish community to restore the estuary gardening of rice root.
- Students can go deeper into the research by studying Leigh Joseph's Master's thesis, *Finding Our Roots: Ethnoecological Restoration of lhásem (Fritillaria camschatcensis (L.) Ker-Gawl), an Iconic Plant Food in the Squamish River Estuary, British Columbia*. <https://bit.ly/2TL9z9V>.

### d. Stone Fish Traps

These large traps were used at the mouths of estuaries where salmon moved from the salt water to the rivers and streams where they would spawn.

- Blackline Master 4-3, page 134 *Stone Fish Traps*
- Gitxaala (Kitkatla) fish traps. Naomi Smethurst. *Inscribed on the Landscape: Stories Of Stone Traps And Fishing in Laxyuup Gitxaala*. Masters thesis, UBC, 2014. <https://tinyurl.com/fnesc30>.
- Heiltsuk fish traps:
  - Heiltsuk Stone Fish Traps. An overview of two sites near Bella Bella with Heiltsuk archaeologist Xanius, Elroy White. theyee, 2012, 2:45 min. <https://youtu.be/jQIQO11cT-8>.
  - Xanius, Elroy White. *Heiltsuk stone fish traps: Products of my ancestors' labour*. SFU M.A. thesis. 2006. <http://summit.sfu.ca/item/4240> (Note: This document can only be read online, not printed.)

 Blackline Master 4-3,  
page 134, Stone Fish  
Traps



## UNIT 4 • SHAPING THE LAND

- J. A. Pomeroy. Stone Fish Traps of the Bella Bella Region. 1976. <https://tinyurl.com/fnesc31>.
  - Tseshaht, Broken Group.
    - Video: Stone Fish Traps. James Thompson Photography. 2014. 0.49 min. <https://youtu.be/rbUPmay2fOI>.
    - Tseshaht Oral History and Ethnography. Ts'ishaa: Archaeology and Ethnography of a Nuu-chah-nulth Origin Site in Barkley Sound, by A. D. McMillan and D. E. St. Claire, Archaeology Press, Simon Fraser University, Burnaby See pages 28 to 30. <https://tinyurl.com/fnesc32>
  - Deep Bay, Vancouver Island.
    - Gregory G. Monks. *An examination of relationships between artifact classes and food resource remains at Deep Bay, DiSe7*. Doctoral Thesis, UBC. Pages 166-169; 303 (pdf pages 179-182; 316). Linked at <https://tinyurl.com/fnesc78>.
- e. Herring
- Coastal First Nations use a number of techniques to encourage herring to spawn on kelp or hemlock branches, making the nutritious eggs easier to harvest. They replicated the natural behaviour of herring spawning along the shoreline.
- Pages 125-127 of *Knowing Home*, Book 1. This includes a diagram of one way of anchoring branches on a log frame.

### Activity 4.6

#### Can Ancient Methods Work Today?

---

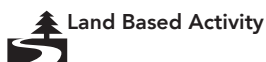

Students will develop a land and resource management plan for a nearby piece of land by adapting traditional First Peoples land and resource management practices.

Some schools are developing or maintaining local or native gardens. This activity could be coordinated with a school garden.

- a. Locate a piece of land that is easily and permissibly accessible by students. Almost any piece of land could work, as long as it has some soil and plants. The more diverse and natural the setting, the better.
  - If circumstances allow, you may be able to find an area where students are able to actually carry out some of their plans, such as a corner of the school grounds or the edge of a woodland area in the community given appropriate permission.
- b. Preparation for site visit
  - Explain the purpose of the field trip. State that they will be going to a project study site for a class project, and their first job is to observe the site



## UNIT 4 • SHAPING THE LAND

to become aware of relationships between the different elements found there.

- Go over expectations for behaviour and safety considerations, and any other protocols that may pertain to the field trip.
- c. Survey the site
- You may want students to begin by developing a sense of place about the site. Use some of the suggestions found in Foundations, Connecting With the Land: Including Land-Based Activities in Your Units, page 21.
  - Have students conduct an initial survey of the land. Activities could include:
    - describing the topography and geological features
    - describing the amount and diversity of plant life
    - photographing major plant species
    - identifying any evidence of animal activity, including mammals, birds, insects, fishes etc.
    - assessing the ecological state of the site; i.e. is it in a natural state? how heavily is it impacted by human activity?
- d. Profile the site
- In the class, students develop a profile of the site. This could include: a map, description of habitat of the site, soil condition, list of plants growing there, possible uses of plants.
- e. Discuss with students how the land on this site could be modified. Ask, What might be the purpose of shaping the land in some way?
- Explain to students that they are going to investigate ways that traditional First Peoples land shaping practices could be applied to this piece of land.
  - Students can work in groups to identify one or more traditional practices that could enhance, improve or make more sustainable the piece of land they studied. (For example, a weed infested yard full of invasive plants could be improved by controlled burning or transplanting roots; a sloping piece of land with high runoff could be levelled by terracing.)
  - Have the groups design a plan that could feasibly be put into practice, deciding on features such as goals and purpose for using the strategy; expected outcomes, resources needed, and time frame.
- f. Groups can present their plans to the class. Discuss ways that these plans could enhance the ecosystem of the site.



### Formative Assessment Strategy

Observe students' work for evidence that they are able to apply First Peoples perspectives to the activity.



### Formative Assessment Strategy

Informally assess students' abilities to apply what they learned about traditional land shaping methods in Activity 2 to this activity.

## Blackline Master 4-1

# Shaping the Land

Here are some of the ways that First Peoples shaped the landscapes of their territories in the past. Many of these methods are still followed today. For each method, tell what you think the purpose of shaping the landscape might have been.

Activity	Purpose
1. Pruning or cutting down plants, such as berries or plants that provide materials for basketry.	
2. Burning individual or small groups of plants	
3. Landscape burning	
4. Digging and tilling the soil before, during and after harvest	
5. Transplanting bulbs or reproductive parts of plants.	
6. Creating terraced gardens	
a. Tidal estuaries	
b. Berry gardens	
c. Clam gardens	
7. Weeding and clearing out competing plants and rocks such as in a blue camas meadow	
8. Adding natural fertilizers such as ashes clamshells, animal or fish remains	
9. Building stone fish traps	
10. Imitating nature	
a. Putting hemlock branches in the sea when herring are spawning	
b. Imitating underwater features with reef nets for salmon fishing	

## Blackline Master 4-1 Sample Responses

# Shaping the Land

Here are some of the ways that First Peoples shaped the landscapes of their territories in the past. Many of these methods are still followed today. For each method, tell what you think the purpose of shaping the landscape might have been.

Activity	Purpose
1. Pruning or cutting down plants, such as berries or plants used to make baskets.	stimulate new growth, stronger plants, more and better quality berries
2. Burning individual or small groups of plants	cleans out the patch of land, encourages new growth, stronger plants,
3. Landscape burning	remove underbrush, improve growth of berry or root plants, create forage for animals like deer
4. Digging and tilling the soil before, during and after harvest	aerates the soil, decompresses soil, plants are more productive, weeds reduced
5. Transplanting bulbs or reproductive parts of plants.	controls the types of plants growing in a plot, sustains the important food plants; spreads plants to new fertile ground
6. Creating terraced gardens	
a. Tidal estuaries	rock or log walls trapped nutrients brought in by the tides and down the river; attracted birds which could be hunted
b. Berry gardens	created prime conditions to grow a variety of species of plants
c. Clam gardens	created the prime habitat for clams, resulting in a higher yield than many regular beaches
7. Weeding and clearing out competing plants and rocks such as in a blue camas meadow	encourages more productive growth, more vigorous plants
8. Adding natural fertilizers such as ashes clamshells, animal or fish remains	additional nutrients improve quality and yield of plants
9. Building stone fish traps	enabled a group effort to harvest fish efficiently, sustainably and selectively
10. Imitating nature	
a. Putting hemlock branches in the sea when herring are spawning	provides an accessible and productive way of harvesting nutritious herring eggs
b. Imitating underwater features with reef nets for salmon fishing	guides or corrals fish to make the harvest more productive

## Clam Gardens

One of the food sources that helped coastal First Nations survive in the past was the clam. If you go to an ancient village site along the British Columbia coast, you will find it is built on deep layers of white shells from clams and other shellfish, like cockles and mussels.

Clams are very nutritious. They are rich in protein, and also nutrients such as iron, Vitamin C and Vitamin D.

There are four main species of clams along the BC coast: butter clam, littleneck, horse clam, and cockles.

### Harvesting clams

Clams and cockles are easy to harvest by all members of the family. They live below the surface of beaches in the intertidal zone. They sometimes give themselves away by squirting water through holes.

In the past, clams and cockles were a dependable food source. People could almost always find a good feed of shellfish, summer or winter.

The best time of year to gather clams is in the winter. In warmer months people knew that they might not be safe to eat. They could be polluted by what we call "red tide."

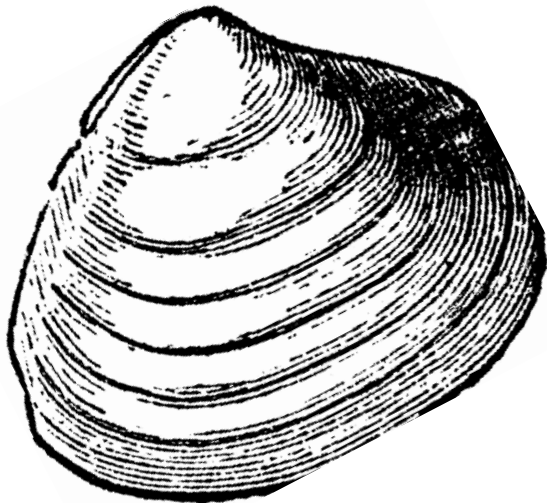

As well as observing the water to see a change in colour, people would watch the animals like seagulls and otters. If they were eating the clams, then people knew they were safe to dig.

### Preserving clams

First Nations families harvested large amounts of clams in the past. Some were eaten fresh, but most were preserved to be eaten later.

The shellfish were steamed open and the meat was threaded onto sticks to be roasted or smoked over a fire. Some people put them between mats and stomped on them to make them more tender.

The dried clams could be stored for a long time, or they could be traded with other First Nations.

The clams made a good snack. Sometimes people strung them on strings which they wore around their neck. If they got hungry while going about their work, they could pull off a clam to eat.

### Clam gardens

We know clams were an important food source in the past because First Peoples built large clam gardens to improve the quality and quantity of the clams.

To do this, people long ago built walls along a sloping beach, and filled it in with sand to make level ground.

All along the Pacific coast, First Nations people built thousands of these beach terraces. In one bay alone on Quadra Island there are at least 49 separate gardens.

It took a great deal of knowledge to build and maintain these gardens. First, the builders had to understand the currents and tides to know the best places to build them.

The clam gardeners must have had a detailed understanding of the intertidal ecosystem to create such successful technology to manage their shellfish harvest.

The walls were as much as two meters high. They were created by rolling boulders down to the lowest of the low tide levels.

The rock walls were built at just the right height so the sandy terrace behind it would create the best growing habitat for the clams.

The waves washing over it would bring in nutrients. As people harvested the clams and cockles, using their digging sticks, they kept the sand loose enough for the shellfish to move about.

Certain people in the community were stewards of the clam gardens. They would observe the condition of the gardens. They would make sure there was no overharvesting. If the quality or number of clams got too low, they would leave the area untouched for a period of time.

Sometimes they would take small clams from another clam beach and “plant” them on a struggling beach.

Scientists have done some tests in clam gardens and found that more clams grow on beaches with walls than regular beaches. As well, clams grow faster and are more likely to survive in clam gardens.

The vast system of clam gardens wasn’t built quickly. They were built over many generations. Families passed on the knowledge and skills involved so that the gardens could be continue to be cared for.

The use of the clam gardens was part of First Nations political and social organization. In some communities certain families or hereditary groups had the use of certain gardens, which were passed down. As well as the rights to use the gardens went the responsibility to care for them.

### **Sea Garden**

The rock walls did more than hold back the sand for the clam gardens. They also created a reef ecosystem where other sea creatures could live, such as octopus, sea cucumbers and chitons. These are all seafood delicacies, and no doubt were an added benefit to the clam gardeners.

## Blackline Master 4-3

# Stone Fish Traps

Stone fish traps were one of a number of fishing technologies used by coastal First Nations to harvest fish. They were an efficient form of **selective** harvesting of a large quantity of fish, but they required a relatively large labour force to build, maintain and operate.

Stone fish traps used the energy from two main sources: the ebb and flow of the tide, and the outward flow of a stream or river into the ocean. They used the falling tide to trap fish behind a rock wall or the stream flow to direct fish into a pond or pool.

### **Building a stone fish trap**

The basic structure of trap is a wall of boulders and stones built in a semi-circular formation along the shore. It required considerable skill and knowledge to select the stones and place them correctly to build a strong wall. It needed to withstand constant tidal action and rough waves.

### **Salmon traps**

Many stone tidal fish traps found along the coast were used to harvest various species of salmon as the migrating fish returned to their birth rivers and streams to spawn.

### **Small fish traps**

In some areas traps were used to catch large quantities of small fish such as herring or perch. These were not near streams, but protected waterways where schools of fish gathered.

### **Working the traps**

Using the stone tidal traps was an active job. People didn't just wait for the tide to trap the fish. They might guide the fish into the trap by splashing with branches or paddles. They may also stand along the wall while the water is high to make sure they fish don't escape.

Once the tide went out the fish could be harvested. Some traps were designed to drain completely, and the fish could be scooped or raked up. Others were designed to hold some water until the fish to be harvested were selected, and the rest released.

### **Social Organization**

Usually it was a hereditary right held by lineage or house chiefs to build a stone fish trap in certain locations. It required the effort of all members of the lineage or house group to build, maintain and operate it.

# Unit 5

## Place-Based Ethnobotany

### Overview

In this unit students look at the relationships between plants and people through the lens of the field of ethnobotany. Particularly, they explore the idea of First Peoples' Traditional Ecological Knowledge about plants as it relates to place.

Traditional Ecological Knowledge about the diverse plants growing in their territories is key to the sense of place held by First Peoples. When First Peoples go out on the land to pick berries, to dig bitterroot, to gather stinging nettle, bark or grasses, it provides a connection with the land and with the ancestors.

As with other resources, traditional knowledge views plants holistically, as a complete living organism interconnected with the rest of the world. There are many dimensions to the wealth of plant resources, such as healing, spirituality, ceremony, nutrition, and technology.

Central to this unit are the ways in which the interconnections that First Peoples have with the land results in a sustainable use of the resources.

The unit builds on students' scientific inquiry which is both respectful of, and informed by, Indigenous perspectives. The focus is on place-based activities as much as possible, as place is the essence of Indigenous knowledge and science. Try to gather as rich a collection of learning materials about the local ecosystems, foods and First Peoples Traditional Knowledge as possible.

A major element of this unit is connecting with the local First Nations community to talk to a member who can present their knowledge about the plants.

## *First Peoples Traditional Knowledge and Intellectual Property Rights*

First Peoples have a strong relationship with the land. Each community, and specific people within communities, have knowledge and understandings of plants discussed in this unit. While much general knowledge has been shared with ethnobotanists and others, in some cases this knowledge is private.

Traditional Knowledge about plants is the cultural heritage of First Peoples and is considered part of a First Nation's intellectual property and should be treated with respect. While much of this knowledge is shared, remember that some understandings of plants and their uses are protected.

### ***Alert: Caution When Using Local Plants***

First Peoples have used plants for millennia, and have the knowledge of how and when to harvest, prepare and use the plants, especially powerful medicinal plants. Some of the plants the students may encounter can be toxic, carrying the danger of serious illness or death if used improperly. Others may be irritating or cause allergies to some people. Take care when handling plants and ensure that students respect the potential harm that could occur without the proper knowledge.

### ***Guiding Questions***

- How can humans interact with plants in a respectful and sustainable manner?
- How have First Peoples used knowledge of plants and their ecosystems to maintain their health and well-being?
- How do First Peoples' perspectives on interconnectedness and place reflect their understandings about plants and their habitats?
- How can Indigenous knowledge and understanding inform the scientific process?
- How do plants support all life?
- How does sustainability relate to ethnobotany and the environment?



## UNIT 5 • PLACE-BASED ETHNOBOTANY

### Relevant BC Learning Standards for Senior Secondary Science

Course	Key Content Standards	Key Curricular Competencies
Science 10	<ul style="list-style-type: none"> <li>Diversity of life</li> </ul>	<p>Processing and analyzing data and information:</p> <ul style="list-style-type: none"> <li>Experience and interpret the local environment;</li> <li>Apply First Peoples perspectives and knowledge</li> </ul>
Life Sciences 11	<ul style="list-style-type: none"> <li>First Peoples understandings of interrelationships between organisms</li> <li>First Peoples knowledge on classification</li> </ul>	<p><b>Questioning and predicting:</b></p> <ul style="list-style-type: none"> <li>Make observation aimed at identifying their own questions, including increasingly abstract ones, about the natural world.</li> </ul>
Environmental Science 11	<ul style="list-style-type: none"> <li>Ecosystem complexity: roles; relationships; population dynamics</li> <li>Energy flow through ecosystems</li> <li>Matter cycles through and between living systems</li> <li>Succession</li> <li>First Peoples knowledge and other traditional ecological knowledge in sustaining biodiversity</li> <li>Benefits of ecosystem services</li> <li>Human actions and their impact on ecosystem integrity</li> <li>First Peoples ways of knowing and doing</li> <li>Resource stewardship</li> <li>Restoration practices</li> </ul>	<p><b>Planning and conducting:</b></p> <ul style="list-style-type: none"> <li>Collaboratively and individually plan, select and use appropriate investigation methods, including field work and lab experiments, to collect reliable data.</li> </ul> <p><b>Processing and analyzing data and information:</b></p> <ul style="list-style-type: none"> <li>Experience and interpret the local environment;</li> <li>Apply First Peoples perspectives and knowledge, other ways of knowing and local knowledge as sources of information</li> </ul> <p><b>Evaluating:</b></p> <ul style="list-style-type: none"> <li>Consider social, ethical, and environmental implications of the findings from their own and others' investigations</li> </ul>
Environmental Science 12	<ul style="list-style-type: none"> <li>Soil characteristics and ecosystem services</li> <li>Land use and degradation</li> <li>Land management</li> <li>Personal choices and sustainable living</li> <li>Global environmental ethics, policies and law [including First Peoples perspectives, philosophies and responsibilities]</li> </ul>	<p><b>Applying and innovating:</b></p> <ul style="list-style-type: none"> <li>Contribute to finding solutions to problems at a local and/or global level through inquiry</li> </ul> <p><b>Communicating:</b></p> <ul style="list-style-type: none"> <li>Express and reflect on a variety of experiences, perspectives, and worldviews thorough place.</li> </ul>

## Resources

For further information on these resources, see the annotations in the Bibliography, beginning on page 273.

### Suggested Resources

- Materials: String and stake or little pieces of wood/metal to stick into the ground. (Activity 5.8)
- Bonneau, Nancy. “Shuswap and Okanagan First Nation Root Food Protocols.” Masters Thesis, Simon Fraser University, 2003. Available online at <http://ow.ly/m0If302O93Y>.
- E-Flora BC Electronic Atlas of the Flora of British Columbia. <https://tinyurl.com/fnesc67>.
- Flora and Fauna Survey Techniques, sampling concepts. Linked at <https://tinyurl.com/fnesc64>.
- Quadrat sampling and population dispersion. BiologyMonk, 2014. 5:39 min. <https://youtu.be/mDMOIpXVbVM>.
- Royal BC Museum, Botany webpage. <https://tinyurl.com/fnesc65>.

Resources for Devil’s Club study

- Burton, Carla M. and Philip J. Burton. “Recovery of *Oplopanax horridus* (Sm.) Miq., an Important Ethnobotanical Resource, after Clearcut Logging in Northwestern British Columbia.” *Ethnobotany Research and Applications*, Vol. 14, 2015. <https://bit.ly/2tNiw48>.
- Devil’s club - *Oplopanax horridus*. Identification and characteristics, UBC Forestry, 2018. Video, 1.28 min. <https://youtu.be/YR0xQKOh2Z4>
- Lantz, Trevor C., Kristina Swerhun, Nancy J. Turner. “Devil’s Club (*Oplopanax horridus*): An Ethnobotanical Review.” 2004; 62:33-48 *American Botanical Council*. Online at <https://bit.ly/2ToUgUh>.
- Turner, Nancy J. “Traditional use of devil’s club (*Oplopanax horridus*: Araliaceae) by native peoples in western North America.” *Journal of Ethnobiology* 1982;2:1-11. <https://tinyurl.com/fnesc66>.
- Turner, Nancy and Fikret Berkes. “Coming to Understanding: Developing Conservation through Incremental Learning in the Pacific Northwest.” 2006. *Human Ecology* v. 34, pages 495-513. Online at <https://bit.ly/2H9U9FD>.
- WorkSafeBC, “Toxic Plant Warning: Severe Eye Injuries from Devil’s Club (*Oplopanax horridus*.)” Linked at <https://tinyurl.com/fnesc63>.

## Additional Resources

- MacKinnon, Andy. *Plants of Northern British Columbia*. Lone Pine field guide. 1999.
- Native Peoples, Plants & Animals: Halkomelem. A Halkomelem Ethnobiology Web Site. Simon Fraser University. <https://www.sfu.ca/halk-ethnobiology/> Pojar, MacKinnon, Alaback, Pojar, Jim, MacKinnon, A., & Alaback, Paul B. (2004).
- Pojar, Jim. *Plants of Coastal British Columbia including Washington, Oregon & Alaska*. Partners Publishing, 2016.
- Thompson, Judy. *Traditional Plant Knowledge of the Tsimshian*. 2003. <http://www.ecoknow.ca/curriculum.html>
- Turner, N. (1995). Food plants of coastal First Peoples / Nancy J. Turner. (2nd ed.]. ed., Handbook (Royal British Columbia Museum)).
- Turner, Nancy and Fikret Berkes. Coming to Understanding: Developing Conservation through Incremental Learning in the Pacific Northwest. 2006. *Human Ecology* v. 34, pages 495-513. Online at <https://bit.ly/2H9U9FD>.
- Turner, N., & Royal British Columbia Museum. (1997). Food plants of Interior First Peoples / Nancy J. Turner. (Handbook (Royal British Columbia Museum)).
- Watt, J., & Colyer, J. (2014). IQ: A Practical Guide to Inquiry-Based Learning. Oxford University Press: Oxford. Excerpt: [http://www.oupcanada.com/school/order\\_form/upload/forms/iq\\_sampler\\_3.2\\_2014.pdf](http://www.oupcanada.com/school/order_form/upload/forms/iq_sampler_3.2_2014.pdf)

## Blackline Masters

- 5-1 Sorting Nature
- 5-2 Plants as Indicators
- 5-3 Bitterroot and Indigenous Knowledge
- 5-4 Inquiry Using the 7Es

## Outline of Activities

- 5.1 What is Living?
- 5.2 Traditional Plant Knowledge
- 5.3 Devil's Club Case Study
- 5.4 Bitterroot Case Study
- 5.6 Cultural Plant Use: An Ethnobotany Inquiry
- 5.7 Interviewing Elders and Knowledge-keepers
- 5.8 Evaluating Biodiversity
- 5.9 Make a Herbarium
- 5.10 Plants in Technology

## Suggested Activities

Note: There are more activities here than most teachers will incorporate into their units. It is not expected that you will use all of the activities, or follow the sequence as it is described. These activities are intended to be adapted to fit the needs of your students and classroom, as well as inspire ways that you can respectfully include relevant Indigenous knowledge and perspectives in your course.

### Activity 5.1

#### What is Living?

---

Students investigate two different perspectives on what is living.

- a. Give students a collection of images that show a diversity of items from nature, and have them sort the pictures in as many different ways as they can.
  - Students can use the images on Blackline Master 5-1, page 154, *Sorting Nature*, or you could have the class collect images. They should include a variety of things found in nature, such as plants, animals, rocks, rivers, sun or moon, and natural phenomena like a rainbow.
    - The images shown on Blackline Master 5-1 are: Row 1: amoeba, chiton, snowflake; Row 2: rock, mosquito larva, fir cone; Row 3: water, sun, trees; Row 4: bear, berries, rainbow.
  - Students can work in pairs or triads. Have students pick out common elements and group the images in any way that makes sense to them. Have them record the classification rules they use in each case. For example, they may make three groups: animal, plant, and other; or two groups: made of cells or not made of cells.
  - As a class have each group report out about the groupings and common elements they found. Ask, “Does the way you sorted the pictures say anything about how you see or understand the world?”
- b. Then ask students to identify what all of the items in the collection have in common. What elements or features do they all share?
  - Ask the groups to brainstorm as many shared features as they can. (For example, all part of the natural world; all are made of molecules or atoms; all transform energy; all are affected by gravity.)
- c. Discuss the perspective of many First Peoples that all things are living. Consider the phrase, ‘We are all made of molecules.’ Ask questions such as:
  - What does “we are all made of molecules” mean to you?
  - How might it be seen from an Indigenous perspective?

 Blackline Master 5-1,  
page 154, *Sorting  
Nature*

## UNIT 5 • PLACE-BASED ETHNOBOTANY

- d. Read “The Creator and the Flea Lady.” In this narrative, told by Ellen Rice White in *Legends and Teachings of Xeel’s, the Creator*, everything is alive and has energy. See Unit 1, Activity 1.4 for a discussion of this story.

Teach or review the terms biotic and abiotic. Next have groups organize the abiotic images into factors which are supportive of biotic processes and those which are not. Likewise have students break up the biotic pictures into plants and animals. Write on the whiteboard the following questions, or variations on them, for group discussion:

- What abiotic factors support the biotic process and which ones don’t? What are the reasons for this?
  - In what ways are plants and animals similar and different? How are they mutually supportive? Can either be detrimental to each other?
- e. Ask students to reflect on the view that everything is alive or living. Ask questions such as:
- What impact might a perspective that all things are living have on how people interact with the environment?
  - How do you personally feel about the view that everything is alive?

**Cross-Curricular Connection**  
English Language Arts

Legends and Teachings of Xeel’s, the Creator by Ellen Rice White.

 **Unit Link**  
See Unit 1, Activity 1.6, Two Ways of Seeing the World for activities about “Two-Eyed Seeing.”

### Activity 5.2 Traditional Plant Knowledge

---

Students assess what they know about Traditional Ecological Knowledge, and the plants used by First Peoples in your region.

- a. What is Traditional Ecological Knowledge?
- Review or introduce the concept of Traditional Ecological Knowledge. If you haven’t done so yet, you may want to use ideas from Activity 1.1, Unit 1, page 38.
- b. Plants as Indicators
- To begin thinking about Traditional Ecological Knowledge students can investigate the example of plants as indicators of significant events.
    - Plants are frequently used as indicators or signals of the timing of other events in First Peoples’ seasonal rounds. When people notice a certain flower blooming in the spring, they can reliably predict that another important event is about to happen.
    - Understanding plants as indicators demonstrates First Peoples’ understandings of the interconnected relationships between plants and other organisms.
  - Students can use Blackline Master 5-2, page 155, *Plants as Indicators*, to find some examples.

 **Foundations**  
Traditional Ecological Knowledge, page 13.

 **Unit Link**  
Traditional Ecological Knowledge, Activity 1.1, Unit 1, page 38

 Blackline Master 5-2, page 155, *Plants as Indicators*

## UNIT 5 • PLACE-BASED ETHNOBOTANY

- Ethnobotanists call indicator species phenological indicators. Students could investigate what phenology means, and how this relates to TEK. (Phenology is the timing of events in the life cycles of plants.)
  - With students, find out some examples of plants as indicators in the local region. Consult Elders and knowledge-keepers, as well as available print resources.
  - Discuss with students the types of scientific knowledge and skills that are important when people use plants as indicators.
    - How does using plants as indicators demonstrate the idea of interconnectedness?
    - How do indicator plants help to create a “sense of place” for local First Nations communities?
- b. Have a discussion about the plants that local First Peoples harvest and use. Depending on your class, some students may be very familiar with them and involved in the harvesting and processing of the plants. Others may be able to make predictions, while others may have little or no prior knowledge.
- c. Display some pictures of different local plants that are important to local First Nations communities. You may be able to find pictures in books or online, or your school or district Aboriginal Education department may have resources you can borrow.
- Where possible, find the names of the plants in the local First Nations language before you show the pictures.
  - As you show various pictures to students, ask them if they are familiar with their names or how they are used.
- d. For further activities about local plant knowledge, see Traditional Plant Knowledge of the Tsimshian by Judy Thompson, 2003.  
<http://www.ecoknow.ca/curriculum.html>
- Ask students to find out what the most significant plants for First Peoples are in your region? What makes them significant? How does their use incorporate Traditional Ecological Knowledge?

### Activity 5.3

#### Devil’s Club Case Study

---

You can use the devil’s club to model some aspects of an ethnobotanical study. It is one of the most significant plants for First Peoples in most of the province. It occurs almost everywhere except for the northern boreal forests.

- a. Begin the lesson by showing a picture of Devil’s Club, or if possible, bring a sample in.
- Students could view a short video which illustrates its features and

## UNIT 5 • PLACE-BASED ETHNOBOTANY

characteristics. See Devil's club - *Oplopanax horridus*. Identification and characteristics, UBC Forestry, 2018. 1.28 min.

<https://youtu.be/YR0xQKOh2Z4>

- Students can discuss or list the most obvious physical features of the plant.
  - Tell or have students find out the binomial scientific name for the plant. (*Oplopanax horridus*). Discuss how it might have received this name.
  - Ask students why they think this plant received such foreboding names in English and Latin. Ask, “What does this tell us about the Western scientific perspective on the plant?”
- b. Ask if any of the students have any experience with this plant. Students can volunteer to talk about stories or encounters they have had with it. For example, there could be some who have had allergic reactions or told to avoid it.
- c. Present information you have gathered about local First Nations' knowledge and use of devil's club. This may include guest speakers, references to books, or going on a walk to observe a plant. Students whose families have had experiences with the plant could ask their families for information and stories.
- Student should learn the name for devil's club in the language of the local First Nations. They may be able to find the name by consulting with the First Nations language teachers or dictionaries of the language.
    - They could also use the FirstVoices website ([firstvoices.com](http://firstvoices.com)) which has web-based dictionaries of a number of BC First Nations. They could either enter “devil's club” into the search field on the home page, to see the word in a number of languages, or they could go to the specific page for the local First Nations language, if it is there.
- d. Have students research to find out different ways that BC First Nations use devil's club. They can focus on the local community's knowledge, but also include information from other cultural groups. Some sources of information include:
- Ethnobotanical plant guides. Your library may have a number of books that have been published, covering both the whole province and specific cultural groups.
  - Ethnobotanical articles, such as:
    - Devil's Club (*Oplopanax horridus*): An Ethnobotanical Review by Trevor C. Lantz, Kristina Swerhun, Nancy J. Turner. *HerbalGram*. 2004; 62:33-48 American Botanical Council. Online at <https://bit.ly/2ToUgUh>.
  - Harvesting devil's club has special protocols in most First Nations communities. For example, only trained people can harvest it for medicine, and it is usually harvested in a remote place. For further examples see page 503 of Turner and Berkes, *Coming to Understanding: Developing Conservation through Incremental Learning in the Pacific Northwest*. <https://bit.ly/2H9U9FD>.

## UNIT 5 • PLACE-BASED ETHNOBOTANY

- See also WorkSafeBC, “Toxic Plant Warning: Severe Eye Injuries from Devil’s Club (*Oplopanax horridus*.)” Linked at <https://tinyurl.com/fnesc63>.
  - Discuss with students what types of information could be gathered about devil’s club. Together they should create a list of topics that can be researched. These could include:
    - habitat; ecosystems
    - life cycle, how it reproduces
    - interconnectedness with plants and animals
    - distribution, where in the province it grows
    - how it used by First Peoples
    - role played in First Peoples’ belief systems
    - management techniques First Peoples used
- e. After students have learned about the importance of the devil’s club to First Peoples, have students compare the perspectives of Indigenous knowledge and Western science.
- Discuss the feelings that the English and scientific names evoke. (fear and danger; the name and understanding of the plant creates fear while the Indigenous understanding creates opportunity.)
- f. Learning from a Scientific Paper
- Students can learn about an ethnobotanical study involving devil’s club by studying a recent scientific article. In this study scientists investigated how well devil’s club recovered in an area that had been clearcut.
- Find the study report online at:
    - Carla M. Burton and Philip J. Burton. “Recovery of *Oplopanax horridus* (Sm.) Miq., an Important Ethnobotanical Resource, after Clearcut Logging in Northwestern British Columbia.” *Ethnobotany Research and Applications*, Vol. 14, 2015. <https://bit.ly/2tNiw48>.
  - Students could work individually, in groups or as a class, depending on how well they are able to analyze a scientific paper.
  - Students should focus on the Objectives (p. 3), Discussion (p. 10) and Conclusions (p. 11) to help them understand the purpose of the study and what the results were.
  - Ask students to summarize this study in their own words. Ask questions such as:
    - Why was there a need for this study?
    - What were the goals of the study?
    - What were the main conclusions?
    - How does this study benefit First Peoples?
    - How can the knowledge learned from this study be applied in the future?



## Activity 5.4.

### Bitterroot Case Study

---

This activity provides an example or model of a plant study that illustrates different types of Traditional Ecological Knowledge.

- a. Introduce the important plant bitterroot using Blackline Master 5-3, page 156 *Bitterroot and Indigenous Knowledge*.
- b. Ask students to create a graphic organizer or mind map to illustrate the many different types of knowledge First Peoples traditionally held about the bitterroot plant and its habitat.
  - Sample responses: Some of the areas of knowledge featured in the article include: the names in the language; where, when and how to harvest the plant; how it is connected to both the cultural and physical aspects of life; how to prepare it; how to harvest sustainably and how to manage the landscape to maintain and increase the potential harvest.
  - Ask students if they think there is any information missing. What further questions can they think of that could tell more about how the bitterroot fit into the lives of the Interior people in the past and the present?
    - For example, the article does not discuss traditional narratives that might talk about the importance of the bitterroot.
  - Ask students to identify the parts of their graphic or map that relate to “place,” that is to the local environment and the relationships the First Peoples have with it.
- c. You may want to discuss ways that the First Peoples traditionally used the land in sustainable ways. How did their beliefs in the interconnectedness of all things affect the way they harvest these and other plants?
  - You may want to make connections with Unit 4, Shaping the Land, to investigate ways First Peoples managed the landscape and harvested sustainably.
- d. Compare nutritional value. Ask students to study the tables of nutritional values for the bitterroot and the carrot. Can they decide which plant is better for you?
  - Students should note that the bitterroot values are for the dried plant, while the carrot values are for the raw plant. Also, they may question the validity of these single sources of information.
  - Ask students to design a way to be able to more accurately compare the nutritional values in these two tables.
- f. For an additional resource see *Shuswap and Okanagan First Nation Root Food Protocols*, an informative Masters’ Thesis by a First Nations scholar, Nancy Bonneau. She studied the protocols and harvesting practices of two important plants, bitterroot and springbeauty. It contains excerpts of interviews with people who still harvest these plants today. <http://ow.ly/m0If302O93Y>.

 Blackline Master 5-3, page 156 *Bitterroot and Indigenous Knowledge*.

## Activity 5.6

### Cultural Plant Use: An Ethnobotany Inquiry

Students conduct an inquiry into the relationship between local First Peoples and one or more plants and their habitats.

- a. Introduce the Inquiry activity. You could read the following or create your own introduction which suits your local context and place:

*Inquiry is about inspiring curiosity through the formulation of questions about something of interest. It is this curiosity which drove the coastal First Nations of BC to build their fishing nets or develop uses for a potentially hazardous plant like Devil's Club. It is curiosity which pushed the Wayfinders and explores across treacherous oceans to new islands and lands. It is curiosity which created smart phones and computers and which drove humanity to land a rover named Curiosity on a planet named Mars.*

- At this point students could view the short video of NASA's Mars Rover Curiosity: <https://youtu.be/Txti0XLxOzI>
- Continue with your introduction:

*Curiosity is the start of inquiry. It lays the foundation. One of the reasons humanity is driven to explore Mars is a result of a fundamental, and culturally transcendent, inquiry question: Is there life beyond this fragile blue planet of ours? Yet this question is massive. So massive it creates a multitude of other inquiries which moves the inquirer into questions of early life forms. Some of the earliest life forms on earth were plants. Thus, the inquiry into ethnobotany can give us insights into what early life is like and how more complex life either benefits or is hurt by it. Now it is time for you to develop your own inquiry questions about your plant. Remember that inquiry itself is based on creating questions which drive curiosity forward.*

- b. Provide students an opportunity to explore possible topics by presenting a variety of resources to inspire their thoughts.
- Set up a centre or display area of pictures, books, and real life objects.
  - Create a class list of local plants that are used by First Peoples, or were used in the past. This could be posted on a chart or other display.
  - Ask students to classify the different ways that First Peoples traditionally use plants: for food, for technology, for beverages and for medicines.
  - Visit a local museum or nature centre that has information about local First Nations' plant use.
  - Invite a First People's artist or craftsperson who uses plant materials to display their work and speak about their craft. (E.g. carver, canoe builder, basket weaver)

## UNIT 5 • PLACE-BASED ETHNOBOTANY

- c. Decide how your class will engage in the inquiry activity. Students could work in groups, or individually.
- Decide on a way for students to select a plant to study, depending on your class makeup. Students could choose a plant that interests them, you could directly assign a plant or you could hold a lottery and pick the plants from a hat.
- d. Discuss with students how to create good inquiry questions. Reference some of the inquiry questions from the Mars Curiosity Rover video. Ask, what are the characteristics of good inquiry questions?
- Spend time discussing with students possible big ideas that could direct their inquiry. The class can hold a brainstorming session where students suggest a variety of questions. They can be posted on chart paper, or for older students, online at a class forum or wiki, if available.
  - Where appropriate, you can guide students to reformulate some questions. Help to connect student ideas and questions to the curriculum.
  - Ask students, or groups, to formulate an inquiry question that they will explore.
- e. Use the 7Es model to help organize students' inquiries.
- Adapt the learning processes about the 7Es, discussed in Foundations, 7E Model, page 31.
  - Use or adapt Blackline Master 5-4, page 158, *Inquiry Using the 7Es*.
- f. Next students should outline three or more steps they could take to facilitate answering the inquiry question.
- What sources could they use in their research?
  - Who are people of knowledge that the group could contact?
  - Where could they go to observe or interact with the plant?
- g. Have students bring their research to respond to their inquiry questions.
- It is also possible to bring in a class set of botany books if access to the computer lab or library is not available; however, it is encouraged that students get time in both of these to conduct their research.
  - Depending on what you have already done with your class it might be helpful to discuss best practices within regards to research. A discussion of sources, documentation, plagiarism, etc. may be important at this stage. Assess where your class is and plan accordingly.
  - Remind students that it is imperative that they have good note taking and information gathering techniques so that they can utilize what they research in their final product.
- h. Guide students' exploration of their questions.
- Discuss different ways they could find answers to their questions, such as story, scientific inquiry, asking local First Peoples, online and print resources.

 Blackline Master 5-4,  
page 158, *Inquiry Using  
the 7Es*

## UNIT 5 • PLACE-BASED ETHNOBOTANY

- Encourage students to “think outside of the box” as they investigate their plant. Here are some possible suggestions to investigate:
  - Research First Nations knowledge and usage of the plant
  - Consult historical accounts of the plant
  - Contact a local botanist/ethnobotanist at the university/college
  - Research academic journals and articles
  - Find botany books at library which will have technical identification procedures
  - Find pictures on the internet of the plant
  - Go out and take pictures and video of the plant.
  - Create a drawing of the plant.
  - How frequent is this plant in my community? Are there any “hot spots” and what is the distribution?
  - Ask parents, elders and community members where they might have seen this plant.
  - Use smartphone to take pictures with geo-tagging
  - Plot geo-tagged pictures onto Google Earth
  - Is climate change affecting this plant? If so how?
  - Talk to indigenous elders who have long memories about harvesting and yields which can be traced back to their grandparents.
  - Search for any climate change research on my plant.
  - Look for any harvest logs or historical data about size, frequency, etc.
  - Is development/industrialization affecting the plant?
  - Which animals use this plant and how?
- i. Communicating Inquiry Findings. Students should decide on how to present the findings from their inquiry. Ask them to think about the best format for their content. For example, is it best told visually, with a video, digital presentation, or gallery? Or does it fit a narrative form, told in a story or graphic novel format. It may be best to present a lot of information clearly, using a poster or a pamphlet.
- j. Hold a culminating activity where students can present their findings. It could be as a presentation to invited guests, such as members of the local First Nations community or another class.

## Activity 5.7

### Interviewing Elders and Knowledge-Keepers

If possible, organize an opportunity for students to interview First Nations Elders or knowledge-keepers about local plant uses. This will be the most authentic way to participate in ethnobotanical research.

If and how this happens will very much depend on the location of your school and the relationship with a local First Nation.

- a. Important considerations when sharing with Elders and knowledge-keepers  
The first step in interviewing an Elder is respect. Elders have both their own lived experience and the stories of their ancestor's lived experiences. This carries just as much weight, if not more, than a person with western academic credentials. It can be very exciting talking to elders because their knowledge can go back to their grandparent's stories about harvesting or what it was like. If students have a chance to talk to an elder in their 80s or 90s this could be knowledge of up to 200 years ago.
- b. Developing questions. It is imperative that students are prepared before they meet the Elder or knowledge-keepers.
  - Have each group come up with questions about their plants. How many will depend on your class size, group sizes and your conversations with the Elder or knowledge-keeper. You do not want to swamp them with questions. A reasonable number would be 10 to 20 questions. If you have too many questions you could ask for multiple interviewees or possibly there are some who are particularly knowledgeable about a certain plant a group is studying.
  - Questions for Elders/bands can be wide ranging. For example, you could ask about harvesting and changes they have seen or changes from the stories of their parents/grandparents. Let's say a group of students is focusing on Salmonberries. Questions could include:
    - When do you harvest salmonberries?
    - Have you noticed this harvest becoming later or earlier in the year?
    - Have the berries become juicier, sweeter, plumper? Or are the berries less tasty and waterier?
    - Have you noticed the berries growing in new places or have they receded?
  - These could be great questions for assessing potential climate change effects on salmonberries.
  - There are many more questions students could ask such as:
    - Are there any traditional stories you would be willing to tell about salmonberries?
    - How do you preserve the berries?
    - What are some of your favorite ways of eating salmonberries?



**Formative Assessment Strategy**

Debrief and discuss with the whole class after each interview. Discuss with the class what went well and where the class could have improved. If doing multiple interviews, be sure to have class make suggestions for the next interview.

- Students could also inquire about elements which support plant life or the harvest. For example, they could ask about the rates of rain, sun, snow, temperature, etc.
- Consider contacting more than one community, if your school is near several communities. Students may come to know more about the diversity of ways that plants are used, stories, or other insights.

- c. Conducting an interview. There are several ways to conduct the interview:
- A visitation to the class
  - Field trip to the band office/reserve/elder
  - Through online video conferencing software or a phone conference
  - E-mailing the questions and getting a written response
- If you choose one of the three first methods you should e-mail the questions to the interviewee before the meeting so they have time to think and prepare their responses. Ideally organizing with the band/elder should take place a couple weeks prior to the interview.

## Activity 5.8

### Evaluating Biodiversity

---



Land-based activity

Students have an opportunity to get out of the classroom and do some field work using the scientific technique of quadrats. This lesson can be approached in different ways depending on your school setting and community.

- a. Explain or review with the class how quadrats work and what their function is. This could take up to one or more class periods depending on the background knowledge of the students.
- For more information about using quadrats, see:
    - Webpage: Flora and Fauna Survey Techniques, sampling concepts. Linked at <https://tinyurl.com/fnesc64>.
    - Video: Quadrat sampling and population dispersion. BiologyMonk. 2014. 5:39 min. <https://youtu.be/mDMOIpXVbVM>.
- b. After the students understand the fundamentals of a quadrat to your satisfaction take the class to a field with grass. Have groups find a random location throughout the field and proceed to collect quadrat data. Use this to estimate how many blades of grass, or other flora, are on the field.
- c. Have students apply the quadrat technique to analyze the population (and dispersion if you or they are so inclined) of their chosen plant within their community. How this is done will depend very much on your community, school culture and access. There are many ways to do this depending on the technology and resources available. Here are two suggestions:

## UNIT 5 • PLACE-BASED ETHNOBOTANY

- Map method
  - Take out a map of your community.
  - Have the class (or individual groups) pick out 3 or more spots to survey within the community. Use a ruler and the map scale to assess distance, OR, once on site use the number of steps, OR, use string that you can measure, OR, use streets or landmarks. A group's method will depend largely on what plant they have chosen and distance.
  - If you have the capacity, take your class out to these three sites and have the groups survey for their plants. An alternative would be to let groups go during class time and have them report back at the end of class. Your method will depend on your capacity and school/district culture.
- Another method would be to use GPS coordinates and Google Earth. Similar to the method above, the class, or individual groups, would have to pick some particular areas to survey. During the survey they would document the GPS coordinates and any other pertinent information like number of plants.
  - Phones can geolocate images and this could be a great method of documentation.
  - Once students collect the data they can then feed it into Google Earth. Once in Google Earth groups can use the measuring tool to create boxes around their sample areas. This can then be used to calculate the area of the quadrat.

### Activity 5.9

#### Make a Herbarium

---

Students participate in the creation of a plant library known as a herbarium, using locally found plants.

- a. Explain that scientists often collect samples of plants in the field and preserve them in a collection called a herbarium. It is like a plant library which researchers can study.
  - Discuss why it might be important for scientists like botanists and ethnobotanists to collect and catalogue specimens of plants. Some reasons include:
    - other scientists can study them at a later date
    - they can help scientists identify plants that they aren't sure about
    - they can compare a new plant with similar ones and perhaps discover a new species
    - identify invasive species of plants
    - understand the biodiversity of plants in BC
    - undertake genetic studies using DNA from the plants
    - use them for forensic studies to solve crimes

## UNIT 5 • PLACE-BASED ETHNOBOTANY

- Students may be interested to find out about the herbarium at the Royal BC Museum, which has over 200,000 plants in its collection. They can read the website and also view a video in which botanists describes how they collect and preserve specimens for the herbarium. The website and video are found at <https://tinyurl.com/fnesc65>.
  - After students have read the text and viewed the video, ask them to write four questions that can be answered by the information. They can quiz a partner or group to see if they can answer the questions.
- b. Collect plant specimens. You or the class together should decide on how many specimens will be appropriate to collect.
  - How students collect plants will require some consideration, depending on their perspectives, your location, and the types of plants gathered. Here are some suggestions:
    - Work with a First Nations Elder or knowledge-keeper to collect plant specimens mindfully and respectfully. This will be important if students are collecting plants that are significant for First Peoples cultures and traditions.
    - Collect plants from the school grounds.
    - Collect only weeds or invasive plants
    - Collect only plant materials that have fallen to the ground
    - Students can bring plant samples from home.
    - Take a picture or draw the specimens rather than taking from live plants.
  - Follow any protocols and regulations when removing parts of living plants, particularly if they are from places that are significant for First Nations lands, are parks or private property.
  - Discuss why it will be important to collect the plants in a respectful manner. Ask the class how they could individually or as group make sure they collect the plant samples in a respectful way.
- c. Discuss with students what information they should record about the plant and its habitat when they are in the field. They can refer back to the Royal BC Museum video from Activity 5.1-a above.
  - You can have students work in groups to develop their own list of data to be collected, or have the class as a whole develop the list.
  - Possible types of data include: date, location, height of plant; habitat; description of soil; nearby plants; GPS coordinates of location; phenology of the plant at the time of collection (i.e. flowering, fruiting, senescence, etc.), weather, colours of the parts of the plant.
- d. Have students work in groups to decide how to preserve their specimens (unless they are using photographs or drawings).
  - Discuss what scientific principles or knowledge might be used to preserve the specimens.



### Formative Assessment Strategy

Assess students understanding of the relationships of plants and their habitat. Do they just focus on the plant, or consider other elements?



- You may want to have the class agree on some basic parameters so the specimens can be all displayed in the same format, such as all mounting on an 8.5 x 11 page.
  - Students can refer back to the Royal BC Museum video from activity 1 or find some ideas on the internet.
  - If you prefer to provide your students with a procedure to follow, you can find suggestions on the internet. See “Pressing and Preserving Plant Specimens” linked at <https://bit.ly/2Dy8ta0>.
- e. Groups should then create labels for each of their specimens.
- f. Make sure students reference any photos taken from the internet and any description quoted directly from another source (i.e. personal communication, books, etc.)

## Activity 5.10

### Plants in Technology

---

Students can explore the many ways in which plants are used in sophisticated technologies, such as basket making; carving daily implements as well as ceremonial and sacred objects; rope; buildings; transportation and harvesting tools.

- Students can find out about the properties of the wood and other plant materials that make them useful in the many different technologies that use them.
- Bending Wood.** Invite students to explore bending different types of wood that have been soaked in water.
  - Students can design a lab test to see how different woods do or don't bend.
  - Hold a challenge to see who can bend a piece of wood the farthest, and get it to hold its shape.
  - Students should recognize and follow safety procedures when doing this test.
  - Students may want to investigate how First Peoples woodworkers bend wood in their work. (See for example how bentwood boxes are made.)
- Arrange, if possible, an opportunity to observe or work with a First Nations weaver use plant materials such as bark, roots and grasses.
- Discuss with students how continuing to use local plant resources for technologies is important for First Peoples' sense of place.

 **Unit Link**  
See Unit 10, Living Technologies for further ideas exploring First Peoples' technologies.

# Sorting Nature

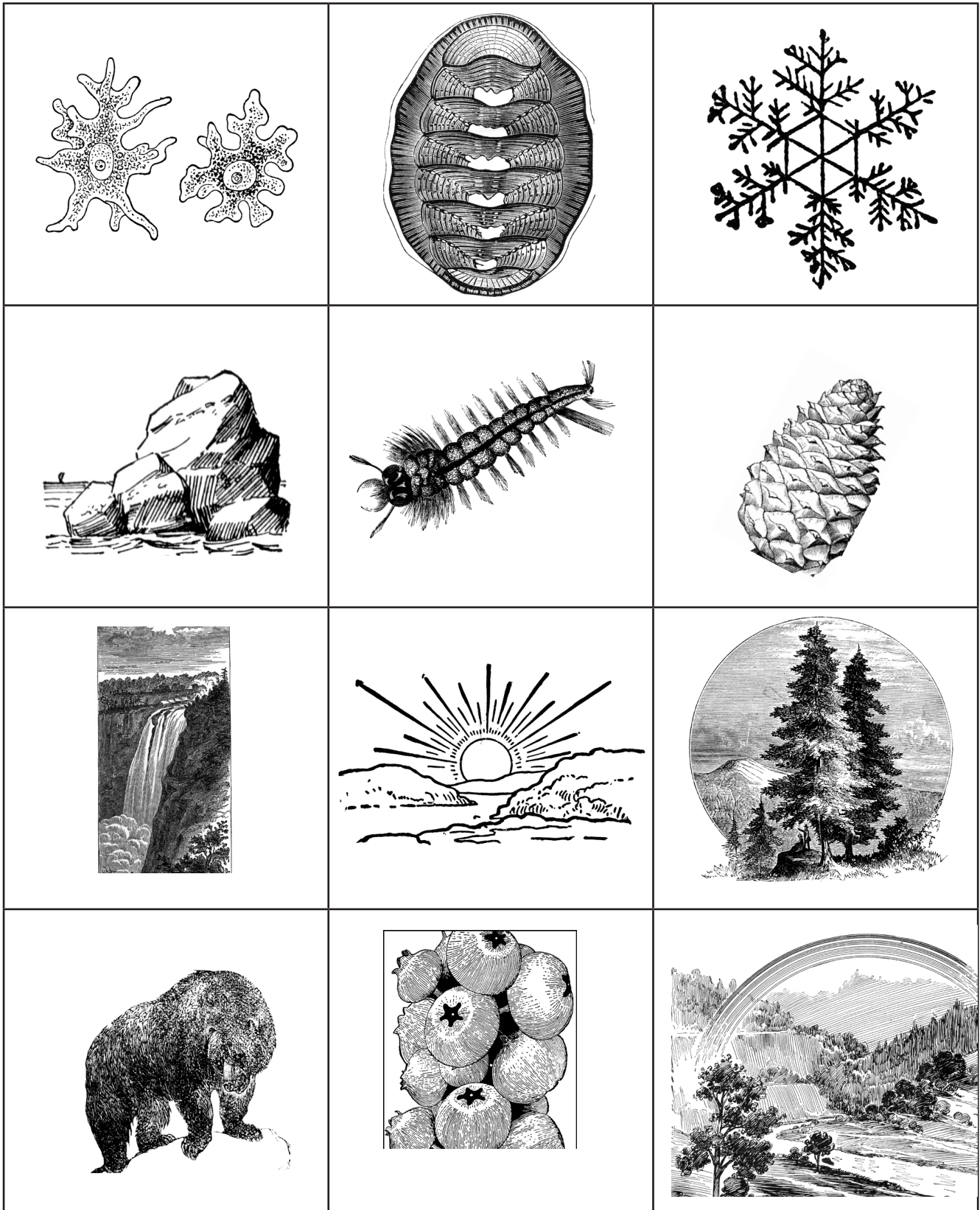

## Plants as Indicators

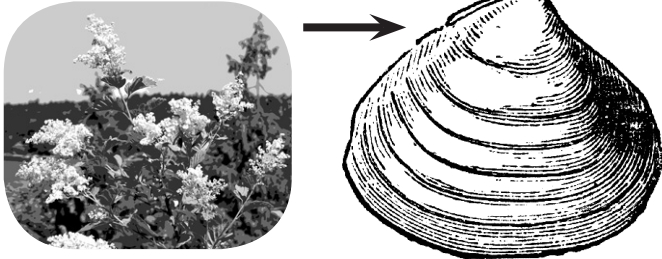

Signal: When the oceanspray plant blooms, the butter clams are ready to harvest.  
Local knowledge of the Comox people.

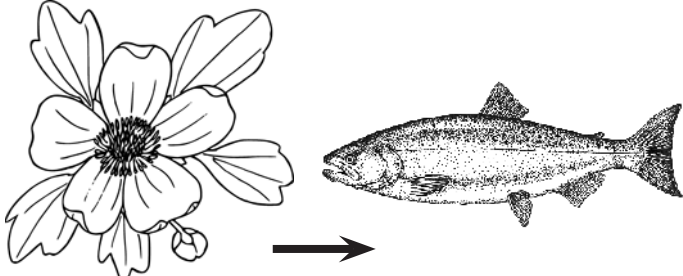

Signal: When the sagebrush buttercup (called spring salmon eye) blooms, it means the first spring salmon are coming up the Fraser River.  
Local knowledge of the Stl'atl'imx people.

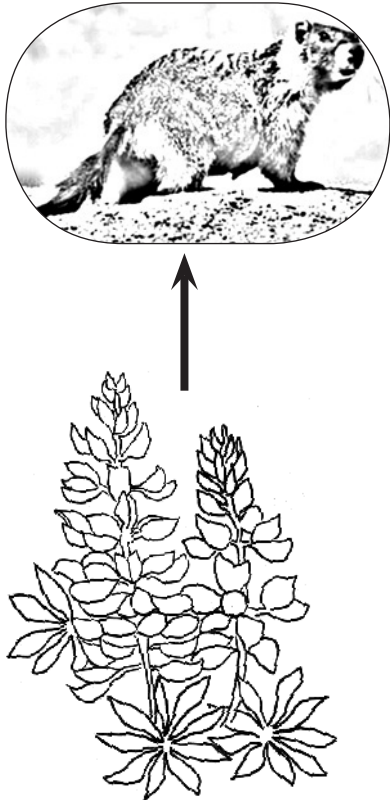

Signal: When the lupine blooms, it is time to hunt marmots.  
Local knowledge of the Okanagan people.

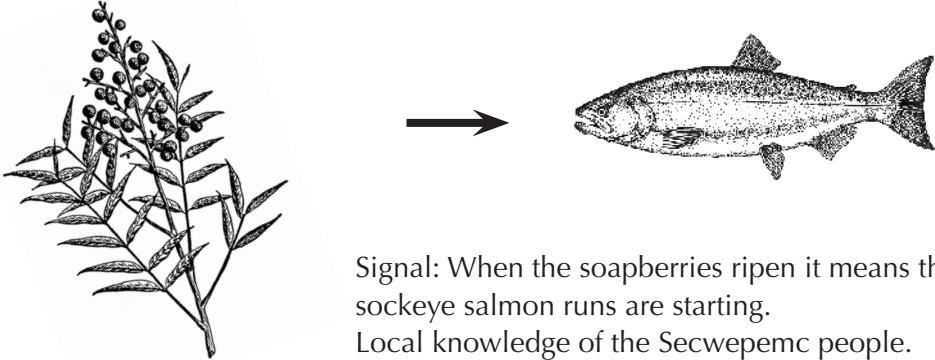

Signal: When the soapberries ripen it means that the sockeye salmon runs are starting.  
Local knowledge of the Secwepemc people.

## Blackline Master 5-3

### Bitterroot and Indigenous Knowledge



**B**itterroot is a perennial plant that grows in dry habitats of the Interior Plateau region of BC. Through most of the year it is hard to see among the grasses and sagebrush that dominate the landscape.

But each April or May, it comes to life for a few short weeks. Bright pink flowers blanket the earth with colour. That is why some people call the plant “desert rose.” Soon, however, the plants dry out and are hidden from view once again.

For thousands of years, bitterroot has been one of the most important plants for First Peoples who live in the driest regions of the BC Interior, including the Ktunaxa, Nlaka’pmx, Okanagan, Secwepemc and Sinixt. They were also important to their neighbours who live in what is now the United States. Part of their Traditional Ecological Knowledge was the high nutritional value of the bitterroot.

The roots are harvested just before the flowering stage, so people have to be able to judge when the roots will be in their best condition. Traditionally it was the women’s role to dig them out of the ground using a digging stick, although in more recent times, all the family may participate.

In most communities, a special ceremony takes place at the beginning of the harvest, sometimes called the First Root ceremony. When the Elders determine that the plants are ready, the first roots of the season are dug, and shared with the community, often at a feast.

Protocols vary by community, but usually involve words and songs of respect and thanks given to the plant for sharing itself with people.

Soon after the roots are dug, the bitter outer skin is peeled off. Then the roots are steamed, pit-cooked or boiled. In the past, some were eaten freshly cooked, but most were dried.

The dried roots can be stored for a long time. Traditionally they were stored for winter supplies, and also for trade with their neighbours where the plant doesn’t grow.

When it comes time to eat them, the dried plants are soaked overnight. They might be added to soups. Bitterroot traditionally is often mixed with other foods such as:

- saskatoon berries and deer fat
- black tree lichen and fresh salmon eggs
- tiger lily bulbs and ripened salmon eggs
- dried gooseberries

In the past, bitterroot grew in tremendous quantities in its native habitat. One observer who visited the Fraser Canyon region 100 years ago estimated that there were millions of plants, at least 100 per square metre in places.

Women harvested large amounts of the roots in the short period that they were available. Sometimes they dug up hundreds or even thousands of roots. You can imagine the amount of work involved to peel and dry that quantity.

You might think that digging out thousands of roots would be harmful for the plants. After all, the whole plant had to be taken. However, the First Peoples always harvested the plants respectfully. If they did not, it could endanger their survival.

Today we would say that they have always followed **sustainable management practices**.

First, their traditional knowledge would tell them if there were enough plants to harvest in large quantities. Often, they would move



from one area to another from one year to the next, so a digging ground could recover.

As well, they dug the roots **selectively**. That means, they didn't clean out one area, but made sure they left enough to grow in the future.

Another method used in the past was to replant parts of the roots. This shows us that the ancient people understood that a piece of a root will grow into a new plant. Scientists call this **vegetative propagation**.

The act of digging the soil with their diggers helped to keep the soil loose so the plants could grow.

**Transplanting** was another sustainable practice applied to the bitterroot. First Peoples sometimes moved the plants from a productive area to a region where there were few plants growing. This demonstrates that part of their TEK was an understanding of habitats, and what a plant needs to survive. This is an example of how some First People's scientific practices brought about a change to the landscape.

These examples of sustainable practices were also used by First Peoples to manage other plant species.

Since colonization, the number of bitterroot plants has been seriously reduced. Many traditional sites have become cattle ranches. Overgrazing and trampling the earth by livestock have packed the soil and otherwise impacted their habitat. Also many sites have become farmland, where the natural plants have been replaced with commercial crops.

Some people still harvest and use bitterroot today. For many First Peoples in the region, it is a strong link to their culture, and helps give them a sense of belonging to the place where they live and where their ancestors once ate and traded the bitterroot in huge quantities.

- **Bitterroot, dried**

- **Nutritional Value**

- per 100 grams dry weight
- calories 387
- calcium (mg) 235
- protein (g) 10
- iron (mg) 33
- carbohydrate (g) 85
- magnesium (mg) 74
- lipid (g) 1
- zinc (mg) 5

Source: US Forest Service.

<http://bit.ly/2dDBjGc>

- **Carrot, raw**

- **Nutritional Value**

- per 100 grams
- calories 41
- calcium (mg) 33
- protein (g) 1
- iron (mg) 0.3
- carbohydrate (g) 10
- magnesium (mg) 74
- lipid (fat) (g) 2
- zinc (mg) 0.24

Source: <https://authoritynutrition.com/foods>

*Compare the nutritional value of the bitterroot with that of another root vegetable, the carrot.*

Sources:

BC Ministry of Forests, Lands and Natural Resource Operations [www.for.gov.bc.ca/rsi/fnb/bitter-root.pdf](http://www.for.gov.bc.ca/rsi/fnb/bitter-root.pdf)

Bonneau, Nancy. Shuswap and Okanagan First Nation Root Food Protocols

Turner, Nancy J. *Ancient Pathways, Ancestral Knowledge*.

Turner, Nancy J. *The Earth's Blanket*.

# Blackline Master 5-4

## Inquiry Using the 7Es

### **Inquiry Question:**

#### **Environment**

Have you gone out to the environment, if possible, and explored your question?

#### **Engage**

What do you already know? What do you want to know about the question?

#### **Explore**

Find out more details about the question.

#### **Elder**

Are you able to learn from an Indigenous Elder or knowledge-keeper? Are there traditional stories related to your topic? What words are there in the local First Nations language?

#### **Explain**

Record your observations and research findings. Plan how you are going to present the answer to your question.

#### **Elaborate**

What other questions come out of your research? Complete your project.

#### **Evaluation**

How did you do? Were you satisfied with the answer to your question?

# Unit 6

## Salmon and Interconnectedness

### Overview

Salmon is an essential resource to many First Nations people and communities in BC. Salmon is found in almost every part of BC, with the exception of northeast regions that are in the Peace and McKenzie River watersheds.

For thousands of years, First Nations peoples have developed an intricate understanding and knowledge about salmon, including the interconnectedness of salmon with other life forms. Before contact salmon was a foundational trade item, contributing significantly to the economy and social structure of First Nations societies. Salmon helped to ensure the sustenance of large, vibrant populations of people. First Nations developed a myriad of technologies to capture and preserve the salmon. The value and respect that the people had for the salmon is reflected in the representation of salmon in traditional stories, songs, dances, and art throughout BC.

One instance of interconnectedness is the remarkable role that salmon plays in returning nutrients to the riverine and forest ecosystems. The carcasses of spawned salmon are taken by other animals such as bears above the river bank, where the molecules of the salmon are cycled through to the forest ecosystem.

For many First Peoples, salmon is inextricably interconnected with their lives, community and culture. As well as making up a significant part of the diet of many First Peoples, salmon forms part of their identity, their cultural practices, their social network, their history and for some, their employment.

As evident in many traditional narratives, salmon has always been respected as a gift to people, but Indigenous knowledge emphasizes that this gift must be reciprocated.

This unit approaches only a few of the many ways to study how salmon is interconnected with diverse ecosystems and human lives. Students learn about the life cycle of salmon and come to understand how integral salmon are to maintaining both the First Nations ways of life as well as the ecosystem around all of us.

## UNIT 6 • SALMON AND INTERCONNECTEDNESS

A principal part of the unit is a long-term field study of a local stream to assess it for its value as a salmon habitat. Students will have the opportunity to collect scientifically significant information from their local environment. The information from the collection of this data will be compared to their newfound-understanding of the needs of salmon to give students stronger placed-based knowledge.

### Guiding Questions

- In what ways are salmon a significant species for First Peoples?
- How are salmon interconnected with other aspects of the natural world?
- How do salmon embody the concept of transformation?
- How can the health and viability of a stream be assessed to determine its suitability as salmon habitat?

### Resources

For further information on these resources, see the annotations in the Bibliography, beginning on page 273.

### Suggested Resources

- Materials for salmon habitat water sampling. See Activity 6.5.
- *D. Suzuki, Salmon and the Forest*. Steven Holzberg, 2013. 5:29 min. at <https://youtu.be/UOtkP-sxk>
- Menzies, Charles R. and Caroline F. Butler. “Returning to Selective Fishing through Indigenous Fisheries Knowledge.” *The American Indian Quarterly* v 31, n 3. pp 441-464. 2007. Download at <http://ow.ly/pdQB302lWrU>.
- *Millions of Salmon Return Home*. National Geographic, 2014. 4:14 min. [https://youtu.be/ZR4\\_LhPCgbo](https://youtu.be/ZR4_LhPCgbo)
- Salmon Anatomy (19:22 min). [https://youtu.be/Nmwhmh\\_6rXI](https://youtu.be/Nmwhmh_6rXI).
- *River of Salmon Peoples*. Theytus Books, 2015
- *St’at’imc The Salmon People*. St’at’imc Government, 2016. 15:45 min. <https://youtu.be/KMtdVqHDrwc>.



UNIT 6 • SALMON AND INTERCONNECTEDNESS

Suggested BC Learning Standards for Senior Secondary Science

Course	Key Content Standards	Key Curricular Competencies
Science 10	<ul style="list-style-type: none"> <li>• Patterns of inheritance</li> <li>• Mechanisms for the diversity of life</li> </ul>	<p><b>Questioning and predicting:</b></p> <ul style="list-style-type: none"> <li>• Make observation aimed at identifying their own questions, including increasingly abstract ones, about the natural world.</li> </ul> <p><b>Planning and conducting:</b></p> <ul style="list-style-type: none"> <li>• Collaboratively and individually plan, select and use appropriate investigation methods, including field work and lab experiments, to collect reliable data.</li> </ul> <p><b>Processing and analyzing data and information:</b></p> <ul style="list-style-type: none"> <li>• Experience and interpret the local environment;</li> <li>• Apply First Peoples perspectives and knowledge, other ways of knowing and local knowledge as sources of information</li> </ul> <p><b>Evaluating:</b></p> <ul style="list-style-type: none"> <li>• Consider social, ethical, and environmental implications of the findings from their own and others' investigations</li> </ul> <p><b>Applying and innovating:</b></p> <ul style="list-style-type: none"> <li>• Contribute to finding solutions to problems at a local and/or global level through inquiry</li> </ul> <p><b>Communicating:</b></p> <ul style="list-style-type: none"> <li>• Express and reflect on a variety of experiences, perspectives, and worldviews through place.</li> </ul>
Life Sciences 11	<ul style="list-style-type: none"> <li>• First Peoples understandings of interrelationships between organisms</li> </ul>	
Earth Sciences 11	<ul style="list-style-type: none"> <li>• Evidence of climate change</li> <li>• First Peoples knowledge of climate change and interconnectedness as related to environmental systems</li> <li>• First Peoples knowledge and perspectives of water resources and processes</li> </ul>	
Environmental Science 11	<ul style="list-style-type: none"> <li>• Ecosystem complexity: roles; relationships; population dynamics</li> <li>• Energy flow through ecosystems</li> <li>• Matter cycles through and between living systems</li> <li>• First Peoples knowledge and other traditional ecological knowledge in sustaining biodiversity</li> <li>• Human actions and their impact on ecosystem integrity</li> <li>• First Peoples ways of knowing and doing</li> <li>• Resource stewardship</li> <li>• Restoration practices</li> </ul>	
Environmental Science 12	<ul style="list-style-type: none"> <li>• Changes to climate systems</li> <li>• Impacts of global warming</li> <li>• Mitigation and adaptations</li> <li>• Land management</li> <li>• Personal choices and sustainable living</li> <li>• Global environmental ethics, policies and law [including First Peoples perspectives, philosophies and responsibilities]</li> </ul>	

### **Additional Resources**

- Carlson, Keith Thor. *You Are Asked to Witness: The Stó:lō in Canada's Pacific Coast History*. Stó:lō Heritage Trust. Chilliwack, BC, 1997.
- Fisheries and Oceans Canada salmon life cycle poster to download: <https://bit.ly/2VewtmY>.
- Fisheries and Oceans Canada. Salmonids in the Classroom, <https://bit.ly/2WAPfGl>.
- *Luutigm Hoon – Honouring the Salmon : An Anthology Told in the Voices of the Tsimshian*. Tsimshian Nation, School District 52 (Prince Rupert), 1999.
- *Meet a Local Legend: The Salmon*. Indigenous Tourism BC, 2015. 1.43 min. [https://youtu.be/aRe1ePS\\_hwg](https://youtu.be/aRe1ePS_hwg)
- Monk-McKenzie, Katelyn. *Against the Current: Interconnected Lives of Salmon and People on the Skeena River*. Living Landscapes, Royal BC Museum. Linked at <https://tinyurl.com/fnesc40>.
- Watkins, Stephen. “Life after Death: The Importance of Salmon Carcasses to BC’s Watersheds.” Stephen Watkins. *Arctic* 53:1, pages 92-99. <https://bit.ly/2Nr9qCY>.

### **Blackline Masters**

- 6-1 Salmon Anatomy
- 6-2 Salmon Life Cycle
- 6-3 The Importance of Salmon Carcasses Study Questions
- 6-4 Salmon Habitat Sampling Data Recording Sheet

### **Outline of Activities**

- 6.1 Respecting the Salmon
- 6.2 Salmon Anatomy
- 6.3 Salmon Transformations: Life Cycle
- 6.4 Salmon Ecosystem Interconnections
- 6.5 Salmon Habitat Assessment
- 6.6 Indigenous Salmon Sustainability

## Suggested Activities

Note: There are more activities here than most teachers will incorporate into their units. It is not expected that you will use all of the activities, or follow the sequence as it is described. These activities are intended to be adapted to fit the needs of your students and classroom, as well as inspire ways that you can respectfully include relevant Indigenous knowledge and perspectives in your course.

### Activity 6.1

## Respecting the Salmon

---

Students build on their understanding of the importance of the salmon to most First Nations in BC, including cultural, spiritual, economic and nutritional aspects. Where possible, link the activities to local First Nations communities.

- a. There are many resources available to introduce the topic of the relationship of First Peoples and salmon. If possible, identify resources that apply to your region of the province.
  - One suggested resource to introduce the unit is the video *St'at'imc The Salmon People*. This video, produced by the St'at'imc Nation, discusses a number of aspects relating to the fate of salmon in its territories, but it emphasizes the central connections that the salmon has to the life and culture of the people.
  - Other resources to illustrate the First Peoples' relationship with salmon include:
    - *Meet a Local Legend: The Salmon*. Indigenous Tourism BC, 2015. 1:43 min. [https://youtu.be/aRe1ePS\\_hwg](https://youtu.be/aRe1ePS_hwg).
    - *Luutigm Hoon – Honouring the Salmon: An Anthology Told in the Voices of the Tsimshian*. See pages 88-92, “Voices of the Elders” and pages 100-109, “Voices of Today.”
    - *River of Salmon Peoples*. Examples can be found throughout.
    - *You Are Asked To Witness*. This ethnohistory of the Stó:lō contains an Elder's description of a First Salmon Ceremony and other information related to traditional salmon fishing (pages 3-7)
    - Living Landscapes, Royal BC Museum, *Against the Current: Interconnected Lives of Salmon and People on the Skeena River* by Katelyn Monk-McKenzie. See the interviews with Melodie Johnson and Art Mathews. Online at <https://tinyurl.com/fnesc40>.
- b. Share with students a First Nations traditional narrative about respecting the salmon. If possible find one that is relevant to your region. The interviews with Melodie Johnson, and Art Mathews in *Against the Current* include some Tsimshian and Gitxsan traditional stories.

 *St'at'imc The Salmon People*. St'at'imc Government, 2016. 15:45 min. <https://youtu.be/KMtdVqHDrwc>

## UNIT 6 • SALMON AND INTERCONNECTEDNESS

- c. Find out if the local First Nations communities have any traditional ceremonies associated with salmon, such as a First Salmon Ceremony.
- Ask questions such as:
    - What are some of the protocols around the catching of salmon or the disposal of fish bones?
    - Do the people in your area have any predictors or indicators for the size of upcoming salmon runs?
  - For a description of a First Salmon Ceremony in a Stó:lō community, see *You Are Asked to Witness*, page 3-4.
- d. If possible, students can make a list of words relating to salmon in the local First Nations language. They can use Blackline Master 6-1, page 173, *Salmon Vocabulary*, as a guide. These are some words found in many First Nations languages; undoubtedly there are more words that could be added.
- Students can use Blackline Master 6-1 when interviewing Elders or knowledge-keepers, or when using dictionaries for the local First Nations language, if available.
  - Students can refer to the website First Voices (<https://www.firstvoices.com/>) to find salmon-related words in some First Nations languages.
- e. Have students work in groups to list examples of Indigenous scientific knowledge related to First Peoples use of salmon.

 Blackline Master 6-1,  
page 173, *Salmon  
Vocabulary*

### Activity 6.2

## Salmon Anatomy

---

Students understand the anatomy of salmon in terms of the names of their structures as well as their function.

- a. First Peoples Knowledge About Salmon Anatomy.
- If your school is situated in or near a First Nations community that regularly harvests and processes salmon, students could investigate how the people who deal with the salmon understand its anatomy. What evidence can they find of traditional knowledge about the salmon anatomy?
- If possible have students learn the names of different parts of the salmon anatomy in the language of the local First Nations community.
- b. Students can view a video which explains the anatomy of a chinook salmon: Salmon Anatomy (19:22 min). It is available at [https://youtu.be/Nmwhmh\\_6rXI](https://youtu.be/Nmwhmh_6rXI).
- As students watch the video, they can follow along with Blackline Master 6-2, page 174, *Salmon Anatomy Question and Vocabulary Set*.
  - Express to students that the person who made the video said that he is going to eat the salmon, which is one way the salmon is a gift. Students

 Blackline Master 6-2,  
page 174, *Salmon  
Anatomy Question and  
Vocabulary Set*

## UNIT 6 • SALMON AND INTERCONNECTEDNESS

- should know that the salmon in the video gave themselves to further their learning about the natural world around them. The gift of learning and understanding salmon will hopefully help these organisms in the future.
- You may want to stop the video at some places to let students catch up on the parts of the Salmon anatomy. Students that have Internet access outside of class can go back over the video to review this vocabulary and the structure and function of the salmon anatomy.
- c. Challenge the class to work together to create a collaborative mural of a salmon's anatomy. Explain that each student group is responsible for drawing one of the organs or other body parts of the salmon. They also need to write the characteristics of that body part.
- The eventual goal for the entire class is to have the body parts on different sheets fit together into one the entrails of a salmon. Groups will need to coordinate with each other to ensure that one group's picture correctly connects with the next organ/part in the line.

### Activity 6.3

#### Salmon Transformations: Life Cycle

---

Through its life cycle, the salmon is transformed through a number of different phases – from the laying of eggs to mature, spawning salmon returning back to lay or fertilize more eggs. The journey through this life cycle happens in different places over a varying length of time. At the end of this activity, students should have an understanding of the salmon life cycle.

- a. Students can view a video that shows one stage of the salmon life cycle, when the salmon return to spawn.
- A suggested video is *Millions of Salmon Return Home*. National Geographic, 2014. 4:14 min. [https://youtu.be/ZR4\\_LhPCgbo](https://youtu.be/ZR4_LhPCgbo).
- b. Ask students if they know how the Pacific salmon is transformed during its life cycle. Students who are familiar with the salmon, or who have studied it previously can share their understandings of the stages of the salmon life cycle.
- Have students use what they know about the salmon to draw a diagram or a flow chart of the salmon life cycle.
    - If they can, they can sketch what the salmon look like at each stage, and indicate the various locations where the transformations take place.
    - If they feel unsure about what to draw, ask them to predict what they think the life cycle looks like, and different places where it happens.
  - Students can work with a partner to compare their diagrams and check their work. Then they can refer to a poster or diagram of the life cycle to self-correct their diagram. You may have posters of the salmon life cycle to display, or students can find them online. For example, the Department of Oceans and Fisheries has a poster to download: <https://bit.ly/2VewtmY>.

## UNIT 6 • SALMON AND INTERCONNECTEDNESS

- Depending on your students, you may want to provide a blackline master of the life cycle that students can use. For example, the Salmonid Enhancement curriculum package has a diagram on page 11 (page 31 of the pdf) online at <https://bit.ly/2WAPfGI>.
- b. Have students draw what the salmon look like at the different stages in their life cycle. Students could use their first drawings, or create new ones based on what they have learned about life cycles.
- Diagrams or pictures for this activity could come from a textbook or from the internet.
- c. After students have completed their drawings, have students work in groups to figure out how long each stage lasts and where these stages take place (such as estuary, ocean, streambed).
- Group members can research the length of time and location of different stages and then come back together the next day to share what they have found out with the group.
  - Students should save their diagrams to use in later activities. After they have done the sampling or other activities, students can take their Salmon Life Cycle diagrams and introduce new material into the diagram. For examples, they can include all of the obstacles there are to each part of the salmon life cycle.
- d. Have students work in groups to discuss other cycles in nature. They may remember one of the cycles they learned in their Science 10 class, such as change of seasons, the rain or carbon cycle.
- e. Students can communicate their understanding of the transformations that the salmon go through in their life cycle through some form of creative expression. For example, they could portray the salmon as a superhero in a comic book or graphic novel form.
- f. If your class raises salmon fry, look into the possibility of collaborating with your local First Nations community for a traditional release of the fry into local watersheds.
- Here is a video of one example from Penticton when students raised salmon fry and released them in a joint effort. *Freedom for the fry*. (Castanet, 2018.1:24 min.) <https://bit.ly/2WAUmXa>.

## Activity 6.4

### Salmon Ecosystem Interconnections

---

In this activity students explore the remarkable story of how the salmon are interconnected with multiple ecosystems.

Salmon are one of the most important sources of ocean-based nutrients brought to complete the nutrient cycle in forest ecosystems. Salmon hatch in rivers then travel out to the ocean to feed and mature before coming back to their original spawning grounds. With them, they bring back important nutrients from the ocean.

This activity can be adapted to a number of topics, including:

- nitrogen cycle
  - trophic levels
  - salmon life-cycle
  - interconnectedness of spheres
- a. Review or discuss the concept of Interconnectedness from an Indigenous perspective. For some suggestions see Unit 1, Activity 1.4, starting on page 43.
  - b. Ask students to brainstorm as many ways as they can that salmon are interconnected with humans and other species.
    - Explain that scientists have recently uncovered far-reaching connections between salmon and a number of ecosystems.
  - c. Students can view a video in which David Suzuki tells the story of the interconnectedness of the salmon and multiple ecosystems. See the video *D. Suzuki, Salmon and the Forest* (2013, 5.29 min.) at <https://youtu.be/UOtkekP-sxk>.
    - Before viewing, ask students to watch and listen to find out the clue that helped researchers learn about the transformation of marine nutrients into terrestrial organisms. (<sup>15</sup>N)
  - d. Students can read one or more articles to learn more about the salmon's interconnectedness.
    - “Life After Death: The Importance of Salmon Carcasses to B.C’s Watersheds.” Stephen Watkinson. *Arctic*, 2000. <https://bit.ly/2Nr9qCY>.
      - Watkinson is an Indigenous scientist. Have students find places in the study that reflect an Indigenous perspective. Ask how he planned to conduct his study from an Indigenous perspective. See especially page 94-95, Incorporating Traditional Ecological Knowledge, and Personal Background.
      - Advanced students may be interested to look at the results of the study in his master’s thesis, Life after death: the importance of salmon carcasses

## UNIT 6 • SALMON AND INTERCONNECTEDNESS

to watershed function. Stephen Watkinson (UBC 2001) Linked at <https://tinyurl.com/fnesc42>.

- “Salmon nutrients, nitrogen isotopes and coastal rainforests” by Tom Reimchen (2001). It is linked at <https://tinyurl.com/fnesc41>.
  - Both these articles are around twenty years old. Students can search for more recent studies to see if the observations and hypotheses have changed.
- e. After students have engaged with the materials, discuss questions such as
- How does the forest help raise the salmon?
  - What evidence exists that the nutrients from salmon carcasses are mostly marine derived?
  - What evidence is there that other organisms are utilizing these carcass nutrients?
  - What is the relationship between invertebrates and the fish?
  - What is the end result of the carcass deposits for juvenile salmonids?
  - How is the nutrient deposits in salmon carcasses distributed to areas away from the water?
- Student can discuss some of the relationships between the salmon carcasses and the nutrient cycle.
  - Students can write a reflection on the new learning they have experienced.
- f. Students can work in groups to create a representation of the story of salmon interconnections. They could use a graphic form such as a web or infographic; develop a play or video that enacts the story; create a picture book for younger audiences, or design a game that involves the interactions.
- Students should try to include that path taken by nitrogen in their representation.
- g. Students can write a reflection about this activity. They can consider questions such as:
- What was the most surprising thing you learned in this activity?
  - How does this story involve the ideas of transformation and interconnectedness?
  - What are some ways that it important to understand the way the interconnections between salmon and the ecosystems works?
  - The natural world recycles the nutrients from salmon but what do humans that eat salmon do to complete the nutrient cycle?



### Formative Assessment Suggestion

Use the reflection questions to assess students' understanding of the salmon's interconnections with multiple ecosystems.



## Activity 6.5

### Salmon Habitat Assessment

---

Students conduct a field study of an actual or potential salmon habitat to assess the health and viability of the study site as a salmon habitat.

Use the Water Sampling Investigation, Activity 3.4 from Unit 3, Relationships to Water, with the set purpose to assess the stream as a salmon habitat.

This is a multi-day activity. The duration of time on any one day depends on how accessible the location is in relation to your school. Working in teams, the data collection process can be completed by a class in as little as 20-30 minutes.

This is a long-term activity that should continue for several weeks. The goal of this activity is to choose a physical location at a local fish habitat and have students collect biotic and abiotic data over time. The students will then use this data to determine the health and viability of this location as a salmon habitat.

The data collection can happen before students gather historical information or political policies governing your chosen site. Sometimes gathering data from a site can spur increased curiosity into finding out more about that particular location so the background information can be collected after you start collecting biotic data. Monitoring what is going on in the students' own local environment will help them understand perspectives of Indigenous science through place-based experiences.

A possible extension would be for students to share the data they have collected with other schools that share the same salmon habitat and invite them to collect data as well. The sharing of data with other groups will expand their knowledge as well as their personal experience with the environment around them.

- a. Use the suggestions in Activity 3.4 to plan and carry out the field and lab activities, selecting the appropriate tests and observations to assess a salmon habitat.
- b. Data that the students collect will not have any meaning unless they can compare it to some known levels or required standards. Students compare the collection data to water quality standards.
  - “Optimal Water Quality Values for Aquatic Ecosystems) is a brief guide to some major values that are important to salmon, including temperature, dissolved oxygen, biochemical oxygen demand, fecal coliform, pH, nitrates and phosphates and turbidity. It is linked at <https://bit.ly/2CtU4sf>.
  - For a more extensive list of values students can consult the Approved Water Quality Guidelines set by the BC government. The most recent guidelines are linked at <https://tinyurl.com/fnesc43>. Go to the link for “Summary of Water Quality Guidelines: Aquatic Life, Wildlife & Agriculture.”



Unit 3, Relationships to Water  
Activity 3.4, Water Sampling Investigation, page 97

- c. Assessing the habitat and draw conclusions.
- Students can work in groups to develop criteria to use to assess when assessing the habitat.
  - Then they can decide whether or not the stream be make a good spawning ground for salmon. Have them give evidence to support their conclusion.

### ***Stream Habitat Assessment Parameters***

Below is a discussion of some to the key parameters in assessing salmon habitat. Directions for measuring each factors are found in Activity 3.4.

#### 1. Temperature

Water temperature is a very important physical measurement because if the water is too warm salmon become physically stressed and more likely to get diseases. Also, warm water holds less oxygen than colder water causing fish to breathe harder. Salmon eggs can hatch too quickly in high temperature water.

#### 2. Water Depth

- Depth of the water is very important for salmon spawning areas. Different types of salmon require different depths of water because most species have their own specific egg burial depths.
- The link below has information about the spawning ground needs of different species of salmon.  
[https://www.for.gov.bc.ca/hfd/pubs/docs/lmh/Lmh66/Lmh66\\_ch14.pdf](https://www.for.gov.bc.ca/hfd/pubs/docs/lmh/Lmh66/Lmh66_ch14.pdf)
- Associated Activity: Working in groups, have each group make a chart of the water and egg burial depth required by each species of Salmon.

#### 3. Stream Flow Rate

The flow rate of a river will vary both seasonally and in relation to a particular area's current weather averages. Different species of salmon require different flow rates in their spawning grounds. You can find the conditions necessary for different species of salmon on the link in the Water Depth section above.

### **Chemical Measurements**

#### 6. pH

High pH in freshwater streams can decrease the activity levels of salmon and consistent low pH can cause reproductive failure.

#### 7. Nitrates

High levels of nitrates can cause secondary effects in water systems. Plants, including algae, use nitrates as a food source. If they have all they want they can grow at an uncontrolled rate. The result of this is that the plants can cause a fluctuation in the dissolved oxygen level.

- Associated Activity: Have students find out what are acceptable levels of nitrates in water ways.

## UNIT 6 • SALMON AND INTERCONNECTEDNESS

### 8. Nitrites

Elevated nitrite levels can lead to the uptake of excessive chlorine. Nitrite can accumulate in tissues as in gills, liver, brain and muscle.

### 9. Ammonia

Ammonia is what animals produce after they metabolize proteins. It is also an indicator of pollution if the levels are high enough. Ammonia sometimes doesn't allow oxygen to move across the gills in fish. Levels of 0.2 ppm to 0.4 ppm are generally acceptable.

- Associated Activity: Have students research what the effects are in fish if the levels of ammonia are too high.

### 10. Dissolved Oxygen

This is probably one of the most important aspects of the water environment for fish. Salmon need dissolved oxygen in the water to bring across their gills and into their bodies. The effect that insufficient dissolved oxygen can have in salmon crosses every part of their life cycle. Over 9 mg/L is usually the optimum level for Salmon.

## **Observational Measurements**

### 11. Turbidity Test

Turbidity is a quality of water that is readily seen because it is the cloudiness of the water. When particles are suspended in water it becomes cloudy. More particles equals higher turbidity. In salmon, turbidity can alter their physiology and behaviour thus resulting in reduced survival rates of both adult fish and their spawn.

- Associated Activity: Have students research what an acceptable level of turbidity is for salmon. Have students research and report on the sources of water turbidity in salmon spawning habitats.

### 12. Invertebrate Identification

Invertebrates and their presence is very important to salmon species. The young juveniles, after spawning, eat a diet of primarily insects, plankton and invertebrates. A large population of diverse invertebrates will help support large numbers of juvenile salmon thus helping to increase the number that return.

- For this section of the testing you can have students "gently disturb" some of the rocks in the pools to find some of the larger invertebrates. Upon finding some, you can instruct the students to take pictures of them making sure to record the time and date that the pictures were taken. It is best to leave the area as pristine as possible to insure the survival of as many salmon offspring as possible in your sampling area.
- Associated Activity: Pictures taken of the invertebrates in your sampling area can be taken back to the classroom for students to try and

identify. There is a source that you can go to and see a classification and identification key for different types of river or freshwater invertebrates.

### 11. Plant Identification

Once again, we want to identify the plant species in and around the water quality sampling site. These plants are very important because they act like a filter for pollutants entering the waterway. Plants also help to stabilize the shoreline of waterways to reduce erosion.

- Here is a link to a source about the importance of streamside vegetation: <https://tinyurl.com/fnesc44>.
- Plants can be identified using the “E-Flora” Website at <https://tinyurl.com/fnesc67>.

## Activity 6.6

### Indigenous Salmon Sustainability

Students will investigate some First People’s practice ensured that salmon were a sustainable resource.

In the past First Nations employed a number of measures that ensured the sustainability of the salmon fishery. This was based on the underlying concept that you never take more than you need.

- a. Ask students to suggest some ways that they think First Peoples may have made sure that the salmon resources stayed sustainable year after year.
  - Ask how they may have
- b. After discussing student suggestions, share Blackline Master 6-4, page 177, *Traditional Salmon Conservation Methods*.
- c. Have students find out different types of salmon fishing techniques, and explain how they enabled selective fishing.
  - Students can study an article that discusses some traditional fishing techniques of the Gitxaala which ensured sustainability.
    - See “Returning to Selective Fishing through Indigenous Fisheries Knowledge” by Charles R. Menzies Caroline F. Butler. (*The American Indian Quarterly* 2007). Download at <http://ow.ly/pdQB302lWrU>.
- d. Students can create a poster, infographic or digital slide show that illustrates the traditional salmon conservation methods.
- e. Students can consider how traditional fishing technologies and habits at management practices could be applied today. They can refer to the Menzies and Butler article noted above.

 Blackline Master  
6-4, page 177,  
*Traditional Salmon  
Conservation Methods*

# Blackline Master 6-1

## Salmon Vocabulary

### *Species*

fish (general)  
salmon (general)  
female fish  
female fish of specific species  
male fish  
male fish of specific species  
chinook (spring) salmon  
chum (dog) salmon  
coho salmon  
humpback salmon  
sockeye (general)  
*Salmon in certain phases, eg:*  
sockeye (red male spawning phase)  
chum - old chum salmon  
young salmon/jack  
*Salmon relatives:*  
trout  
steelhead

### *Anatomy*

anal fin  
backbone  
belly  
dorsal fin  
fin  
gills  
head  
heart  
liver  
salmon tails  
scales  
slime

### *Life cycle*

eggs, roe  
fish that have spawned  
spawning  
spawn

### *Harvesting*

First Salmon  
fish trap  
net  
to catch fish, to catch salmon  
to troll

### *Processing*

barbecued fish  
boiled fish  
cured, buried salmon eggs  
dried: sun dried  
dried: roast dried  
dried: wind dried  
fresh fish  
smoked  
half-smoked  
jelly from boiled fish heads  
fillets, thinly sliced  
store for winter  
salmon stretcher, stick used to hold it open  
salmon split open  
powdered salmon

### *Seasons or Months connected with salmon*

## Salmon Anatomy Video Question and Vocabulary Set

Follow along with the video to provide details about the structure and function of the following terms.

Hooked Jaw-

Teeth-

Nostril-

Eyeball-

Operculum-

Gills-

Gill Filaments-

Gill Arch-

Gill Rakers-

Pectoral Fin-

Pelvic Fin-

Vent (Urogenital Opening)-

Anal Fin-

Caudal Fin-

Follow along with the video to provide details about the structure and function of the following terms.

Adipose Fin

Dorsal Fin-

Lateral Line-

Colouration-

Top-

Side-

Belly-

Dissection

Heart-

Pyloric Caeca-

Enzymes-

Follow along with the video to provide details about the structure and function of the following terms.

Liver-

Stomach-

Spleen-

Intestines-

Air Bladder (Sac)-

Male Genitalia-

Milt-

Kidney-

Fish Skeleton-

# Stream Study Data Recording Sheet

Recorder Names \_\_\_\_\_

Stream Name \_\_\_\_\_

Location \_\_\_\_\_

GPS Coordinates \_\_\_\_\_

Collection Date \_\_\_\_\_

## General Conditions

Time of Data Collection \_\_\_\_\_ am/pm

Days Since Last Data Collection \_\_\_\_\_

Weather Conditions (describe the weather as you see it...ie clear, cloudy, rainy, snowy)

---

---

---

## Physical Measurements

Current Air Temperature \_\_\_\_\_ Co

Current Water Temperature \_\_\_\_\_ Co

Depth of Water (multiple trials across the stream)

Trial 1 \_\_\_\_\_ (m) Trial 2 \_\_\_\_\_ (m) Trial 3 \_\_\_\_\_ (m) Trial 4 \_\_\_\_\_ (m)

Average Depth \_\_\_\_\_ (m)

Distance across water \_\_\_\_\_ (m) Average Cross Section \_\_\_\_\_ (m<sup>2</sup> )

Total Average Cross Section \_\_\_\_\_ (m<sup>2</sup> )

Stream Surface Velocity (try this 3 times)

Distance in meters between the 2 flagged stakes \_\_\_\_\_ meters

Time it takes for the float to drift between the 2 flagged stakes

Trial 1 \_\_\_\_\_ seconds Trial 2 \_\_\_\_\_ seconds Trial 3 \_\_\_\_\_ seconds

Velocity (m/s) =

Trial 1 \_\_\_\_\_ m/s Trial 2 \_\_\_\_\_ m/s Trial 3 \_\_\_\_\_ m/s

Velocity Average \_\_\_\_\_ m/s

## Stream Study Data Recording Sheet page 2

### Chemical Measurements

pH \_\_\_\_\_ (1 – 14)    Nitrite Test \_\_\_\_\_ 0 – 5 ppm (mg/L)

Nitrate Test \_\_\_\_\_ 0 – 160 ppm (mg/L)    Ammonia Test \_\_\_\_\_ 0 – 8.0 ppm (mg/L)

Dissolved Oxygen \_\_\_\_\_ 2 – 14 ppm (mg/L)

### Observational Measurements

Water Turbidity \_\_\_\_\_ 10 – 250 (NTU)

### Invertebrate & Plant Identification

(these might be identified at a later time from pictures)

Record the date and time of each picture taken

Photo 1 Date/Time \_\_\_\_\_ Identification \_\_\_\_\_

Photo 2 Date/Time \_\_\_\_\_ Identification \_\_\_\_\_

Photo 3 Date/Time \_\_\_\_\_ Identification \_\_\_\_\_

Photo 4 Date/Time \_\_\_\_\_ Identification \_\_\_\_\_

Photo 5 Date/Time \_\_\_\_\_ Identification \_\_\_\_\_

Photo 6 Date/Time \_\_\_\_\_ Identification \_\_\_\_\_

Photo 7 Date/Time \_\_\_\_\_ Identification \_\_\_\_\_

Photo 8 Date/Time \_\_\_\_\_ Identification \_\_\_\_\_

Photo 9 Date/Time \_\_\_\_\_ Identification \_\_\_\_\_

### Streamside Plant Identification

Draw an aerial sketch of where the plants occur in relation to the stream on the next page.

Add the following features where they occur in your sampling location

Log

Riffles

Rapids VVVVVV

Overhanging bank or cutback

Rocks along a shoreline

Garbage or Refuse



## Traditional Salmon Conservation Methods

Conserving salmon populations was vital to most First Nations in BC in the past.

Here are some of the ways that salmon stocks were traditionally conserved:

- World view, cultural protocols and oral traditions entrenched respect for the salmon and recognize the spiritual connections people have with salmon. At the beginning of the season they usually held a First Salmon ceremony.
- Selective fishing technologies. People fished salmon using techniques that were selective, or allowed them to harvest certain types and release others. This relies on knowledge of the right equipment to use at a certain time in a certain place. Knowledge was also need to fish selectively for the particular species of salmon being caught, the time of year, and other factors.
- People limited the number of salmon they took at any one fishing site. They understood the capacity of the river or stream, and made sure to let enough salmon move upstream.
- People looked after salmon spawning habitats. For example they cleared obstructions from a stream to make sure salmon could make their way upriver.
- Some First Nations were known to have improved the productivity of streams that had small runs by moving fertilized eggs from one creek to another.



# Unit 7

## Connecting Food Security and Climate Change

### Overview

Climate Change and Food Security are both broad and important topics. This unit focusses on how they intersect in ways that affect the traditional foods of First Peoples in BC. It also asks students to consider how traditional Indigenous practices might be used to support food security for the wider community.

First Peoples, having lived in the lands we call British Columbia for thousands of years, have always adapted to ecological and climate changes. Their Indigenous Knowledge has generally been able to cope as they adjusted to different conditions.

However, the current rates of change are unprecedented. Traditional Ecological Knowledge is not always able to keep up with the extent of changes. This is compounded by other impacts of industrial society, such as loss of territories and habitats, changing diets and modern technologies.

The topic of food security can be examined in diverse ways, but in this unit students are only asked to consider the security of traditional foods for First Peoples communities, and how it is impacted by climate change.

NOTE: Some sections of this unit dealing with food security could trigger strong emotions in some students who may live in poverty and whose families may rely on food banks, or are otherwise food insecure. Be sensitive to how your students may receive some of the videos and discussions around these topics.

## UNIT 7 • CONNECTING FOOD SECURITY AND CLIMATE CHANGE

### Relevant BC Learning Standards for Senior Secondary Science

Course	Key Content Standards	Key Curricular Competencies
Life Sciences 11	<ul style="list-style-type: none"> <li>• First Peoples understandings of interrelationships between organisms</li> </ul>	<p>Questioning and predicting</p> <ul style="list-style-type: none"> <li>• Make observation aimed at identifying their own questions, including increasingly abstract ones, about the natural world.</li> </ul> <p>Planning and conducting</p> <ul style="list-style-type: none"> <li>• Collaboratively and individually plan, select and use appropriate investigation methods, including field work and lab experiments, to collect reliable data.</li> </ul> <p>Processing and analyzing data and information</p> <ul style="list-style-type: none"> <li>• Experience and interpret the local environment</li> <li>• Apply First Peoples perspectives and knowledge, other ways of knowing and local knowledge as sources of information</li> </ul> <p>Evaluating</p> <ul style="list-style-type: none"> <li>• Consider social, ethical, and environmental implications of the findings from their own and others' investigations</li> </ul> <p>Applying and innovating</p> <ul style="list-style-type: none"> <li>• Contribute to finding solutions to problems at a local and/or global level through inquiry</li> </ul> <p>Communicating</p> <ul style="list-style-type: none"> <li>• Express and reflect on a variety of experiences, perspectives, and worldviews through place.</li> </ul>
Earth Sciences 11	<ul style="list-style-type: none"> <li>• Evidence of climate change</li> <li>• First Peoples knowledge of climate change and interconnectedness as related to environmental systems</li> </ul>	
Environmental Science 11	<ul style="list-style-type: none"> <li>• Ecosystem complexity: roles; relationships; population dynamics</li> <li>• Energy flow through ecosystems</li> <li>• Matter cycles through and between living systems</li> <li>• First Peoples knowledge and other traditional ecological knowledge in sustaining biodiversity</li> <li>• Human actions and their impact on ecosystem integrity</li> <li>• First Peoples ways of knowing and doing</li> <li>• Resource stewardship</li> <li>• Restoration practices</li> </ul>	
Environmental Science 12	<ul style="list-style-type: none"> <li>• Changes to climate systems</li> <li>• Impacts of global warming</li> <li>• Mitigation and adaptations</li> <li>• Land management</li> <li>• Personal choices and sustainable living</li> <li>• Global environmental ethics, policies and law [including First Peoples perspectives, philosophies and responsibilities]</li> </ul>	

### *Cross-Curricular Connections*

Culinary Arts 10; Food Studies 10

- First Peoples food protocols, including land stewardship, harvesting/gathering, food preparation and/or preservation, ways of celebrating, and cultural ownership
- Evaluate the influences of land, natural resources, and culture on the development and use of tools and technologies

### Guiding Questions

- What are the connections between climate change and food security?
- How does climate change affect the diets of First Nations and others living in BC?
- How does food security impact the lives of Indigenous cultures in Canada?
- How can we adapt to climate change to ensure food security for the future?
- How can eating traditional foods increase First People's food security?

### Resources

For further information on these resources, see the annotations in the Bibliography, beginning on page 273.

### Suggested Resources

- First Nations Adapt Program. Government of Canada. <https://bit.ly/2DD2q1q>
- First Nations Health Authority. “Eating Healthy: Traditional Foods Are Good Medicine For Both Body And Soul.” <https://bit.ly/2ExJIKk>
- First Nations Health Authority. *Traditional Food Facts Sheets*. <https://bit.ly/2x5bCKc>
- Forests and Oceans for the Future. Unit 7, Traditional Ecological Knowledge and Climate Change. www.ecoknow.ca. Linked at <https://bit.ly/2DGpg91>
- *From Glaciers to Glass Sponge Reefs*. Kitsumkalum First Nations, 2018. <https://youtu.be/15CxqNnFJSw>
- Gonzalez, Andrea. “Climate Change Threatens First Nations’ Fisheries.” *The Ubysey*, 2016. <https://bit.ly/2Sa2Otp>.
- Great Bear Sea. *Exploring the Great Bear Sea, Environmental Science 11, 12*. <https://greatbearsea.net/environmental-science/>
- Myhal, Brittany. *Food Security Concerns and Challenges of First Nations Communities in the Interior of BC*. Master of Land and Water Systems, UBC, 2018. Linked at <https://bit.ly/2IlkX8a>.
- *River of Salmon People*. Theytus Books, 2015.
- Sterritt, Angela. “In fight to combat climate change, Squamish Nation joins forces to capture carbon” CBC 2018. Linked at <https://tinyurl.com/fnesc71>.
- *A Subsistence Culture Impacted by Climate Change*. Arctic Athabaskan Council. 3 minute video. <https://bit.ly/2cSLeGB>.
- *What's the Deal with Carbon*. Bell Museum, 2010. 3.03 min. Online at <https://youtu.be/2Jp1D1dxxj8>.

## UNIT 7 • CONNECTING FOOD SECURITY AND CLIMATE CHANGE

Resources for studying caribou

- Caribou in British Columbia. BC government brochure. <https://bit.ly/2DiMHWT>.
- Caribou, BC Government web page. <https://bit.ly/2BVB1rt>
- *Project Caribou. An Educator's Guide to Wild Caribou of North America*. Project Caribou. Whitehorse: Government of the Yukon. 2001. <https://tinyurl.com/fnesc37>
- “Governments of Canada and British Columbia to collaborate with First Nations on recovery of Southern Mountain Caribou,” 2018 . <https://tinyurl.com/fnesc68>.

Resources for studying the Three Sisters and Food Forests.

- Appreciating the Three Sisters. 7:25 min. 1995. [https://youtu.be/pb8ANVAhj\\_8](https://youtu.be/pb8ANVAhj_8)
- *Bertha Sky, 3 Sisters Soup*. Factory Media Centre, 2017. 3.28 min. <https://youtu.be/bgineteFOOg>.
- *A Forest Garden With 500 Edible Plants Could Lead to a Sustainable Future*. National Geographic, 2019. 3.23 min. [https://youtu.be/Q\\_m\\_0UPOzuI](https://youtu.be/Q_m_0UPOzuI).
- The Iroquois Legend of the Three Sisters. <https://bit.ly/2D9GMDC>
- Strandberg, Diane. “Coquitlam school partnership to create First Nations forest garden,” Tricity News, 2017. <https://tinyurl.com/fnesc89>
- The Three Sisters: The Haudenosaunee’s Three Sisters. <http://www.oneidaindiannation.com/the-legend-of-the-three-sisters/>
- The Three Sisters curriculum package. <https://bit.ly/2CwEA70>
- Three Sisters Garden. 3.27 min. (made for young children.) <https://youtu.be/SQ4dgTwTpvk>.
- *Urban Food Forest Tour (Canada’s Oldest): Spring Ridge Commons*. Edible Landscapes Design, 2017. <https://youtu.be/CLJlsR7U8uc>.
- “What’s a food forest?” Canadian Feed the Children website, linked at <https://tinyurl.com/fnesc85>.
- “What is Permaculture?” Permaculture Research Institute website. <https://permaculturenews.org/what-is-permaculture/>

### Additional Resources

- Canadian Wildlife Federation. “Strangers in a Strange Land.” Link at <https://tinyurl.com/fnesc38>.
- Looking Into Surface Albedo, UCAR Center for Science Education, linked at <https://tinyurl.com/fnesc39>.
- *Kitsumkalum on Climate Change and Food Security* (4:37 min) <https://youtu.be/VZiuUKu0D00>
- Turner, Nancy J. and Helen Clifton. “‘It’s so different today’: Climate change and Indigenous Lifeways in British Columbia.” *Canada Global Environmental Change* 19 (2009). Available online at <http://bit.ly/2dj8hvY>

## UNIT 7 • CONNECTING FOOD SECURITY AND CLIMATE CHANGE

### *Blackline Masters*

- 7-1 Food and Climate Change Discussion Questions
- 7-2 Food Security
- 7-3 A Carbon Journey
- 7-4 Carbon Transformation Stations
- 7-5 Caribou Data File

### **Outline of Activities**

- 7.1 Climate Change and Food Security
- 7.2 Where Does Your Food Come From?
- 7.3 Traditional Foods and Food Security
- 7.4. Evidence of Climate Change in the Local Region
- 7.5 Carbon Transformations
- 7.6 Albedo and Climate Change
- 7.7 Ecosystem Inquiry
- 7.8 Caribou and Climate Change
- 7.9 First Nations Communities Adapt to Climate Change
- 7.10 Companion Planting: An Indigenous Model
- 7.11 Developing a Proposal To Address Local Climate Changes Issues.

## Suggested Activities

Note: There are more activities here than most teachers will incorporate into their units. It is not expected that you will use all of the activities, or follow the sequence as it is described. These activities are intended to be adapted to fit the needs of your students and classroom, as well as inspire ways that you can respectfully include relevant Indigenous knowledge and perspectives in your course.

### Activity 7.1

#### Climate Change and Food Security

---

Students are introduced to the connections between climate change and food security for First Peoples.

- a. Introduce the topic by having students think about their personal connections with food. This could be a class discussion, group discussions or individual reflection. Discuss questions such as:
  - What are your favourite foods? What foods could you not live without?
  - What about food is important to you and your families? Does food have any cultural or social connections for you?
  - In what ways can food bring your family or friends together?
- b. Have students use the Four Corners strategy to discuss the possible impacts of climate change on the food we eat. This activity gives an opportunity to introduce physical movement into the lesson.
  - To set up the activity, place a question card in each corner of the room. The questions can be found on Blackline Master 7-1, page 204, *Climate Change and Food Security Discussion Questions*.
  - One approach is to divide the class into four groups, and have the groups rotate to each corner to discuss the question they find there. You could assign recorders to stay in each corner and summarize the discussion of each group.
  - Another approach is to allow students to choose one topic they would like to discuss.
    - Explain all four questions.
    - Give students time to think about the questions.
    - Students pick a corner to move to and discuss the question.
    - One or two representatives can share the discussions with the rest of the class.
  - The questions can also be used for small group, whole class, or individual discussions.

 Blackline Master 7-1,  
page 204, *Climate  
Change and Food Security  
Discussion Questions*



## UNIT 7 • CONNECTING FOOD SECURITY AND CLIMATE CHANGE

- These are the discussion questions found on Blackline Master 7-1, page 204:
  1. Do you think climate change has an impact on the food you eat now? If so, in what ways?
  2. How do you think climate change will affect the availability of our food in the future? How might it impact the types of foods we eat and the sources of our food?
  3. How could climate change impact the foods that First Peoples and others who harvest some or all of their food from the land around them?
  4. How do you think climate change will affect the quality of our food in the future? Will it affect the nutritional value of our food?
- c. What is food security? Ask students what they know about the term food security. If they are not familiar with it, ask them to predict what it might mean.
  - Have students find out some definitions of food security from online sources. They could work in groups and share their findings with the rest of the class.
  - Have students refer to Blackline Master 7-2, page 205, *Food Security* to compare the United Nations definition with others they have found.
  - Have students list the key attributes of food security they have found.
- d. Discuss with students four aspects of food security:
  - Availability
  - Access
  - Utilization
  - Stability.
  - Ensure students understand each of the factors. Ask them to suggest examples of each.
  - Students can use Blackline Master 7-2 to record notes, examples or questions about each aspect.
- e. To introduce the connections between climate change and food security for Indigenous communities in BC, use one or more of the following resources.
  - *From Glaciers to Glass Sponge Reefs*. View and discuss this 27 minute video produced by the Kitsumkalum First Nation in 2018. Online at <https://youtu.be/15CxqNnFJSw>.
    - The video shows how one BC First Nation is studying the effects of climate change and finding ways to adapt to the coming changes to ensure they still have access to their traditional food resources.
    - It illustrates how the community uses both traditional knowledge and Western science to understand, monitor and adapt to the changes in their local ecosystems.
    - A shorter video comprised of the introduction to the full video is also available. It could be used as an introduction to the topic if there isn't



### Formative Assessment Strategy

Use the discussion about climate change to assess students' depth of understanding of the topic and guide your further instruction.



Blackline Master 7-2, page 205, *Food Security*

## UNIT 7 • CONNECTING FOOD SECURITY AND CLIMATE CHANGE

time to view the whole video. *Kitsumkalum on Climate Change and Food Security* (4:37 min) is online at <https://youtu.be/VZiuUKu0D00>.

- *Food Security Concerns and Challenges of First Nations Communities in the Interior of BC*. Brittany Myhal, Master of Land and Water Systems, UBC. 2018. Online at <https://bit.ly/2IlkX8a>.
    - This is a report on case studies of two interior First Nations groups, the Esh-kn-am Cultural Resources Management Services (a joint venture of three Nlaka'pamux First Nation Bands: Coldwater, Cook's Ferry and Siska) and the Lytton First Nation.
    - Students could focus on section 4.3, Climate Change (pages 8-9) for an overview and examples of how climate change impacts interior First Nations.
    - Students could then read the two case studies (sections 5.2 and 5.3) to see differences in how climate change affects different communities.
  - *Climate Change Threatens First Nations' Fisheries*. Andrea Gonzalez, *The Ubysey*, 2016. <https://bit.ly/2Sa2Otp>.
    - Students can read about a recent study that predicts the effects of climate change on First Nations marine fisheries. The article summarizes a UBC study examining the impacts of climate change for coastal First Nations communities where marine resources are crucial for both food and economic security.
    - Advanced students can also look at the original study and see some of the data that were collected, and read for themselves the conclusions drawn by the researchers: "Projected Scenarios for Coastal First Nations' Fisheries Catch Potential under Climate Change: Management Challenges and Opportunities." Lauren V. Weatherdon, Yoshitaka Ota, Miranda C. Jones, David A. Close, William W. L. Cheung. *PLOS* January 13, 2016. Online at <https://bit.ly/2V18ub2>.
  - *A Subsistence Culture Impacted by Climate Change*. Arctic Athabaskan Council. 3 minute video. <http://bit.ly/2cSLeGB>. This short video demonstrates the various impacts of climate change on food security of First Peoples' communities in Yukon and Alaska, particularly salmon and the muskeg ecosystem.
- f. Ask students to think about what they have learned about the connections between climate change and food security for First Peoples and other Canadians. Ask questions such as:
- What are two or three new ideas you learned from this resource?
  - What questions do you have about the connections between climate change and food security?
  - What are two of the most important impacts of climate change on the food supplies of First Nations communities?

## Activity 7.2

### Where Does Your Food Come From?

Students work together to cook a dish that requires a variety of different ingredients. Students will then calculate how far the ingredients travelled to get to their plates.

#### a. Planning to Cook

Explain to students that they will be planning and cooking a dish that requires a variety of ingredients, and they will track how far the ingredients they use travelled to get to their plate.

- Plan how the ingredients will be obtained. The school could supply some or all of the ingredients, or students could bring some from home. Depending on your classroom resources and how the supplies are obtained, this activity can be setup in several ways:
  - Groups could prepare one ingredient to add to one dish prepared by the whole class.
  - Groups could prepare the complete dish on their own, and compare them.
  - Groups could prepare different dishes. This could give the opportunity to compare dishes made with mostly local foods to dishes made with mostly imported foods.

#### b. Depending on your situation, you may want to decide on the recipe or recipes to make, or allow the students to contribute to making the decision. Some suggested dishes that students could make are:

- Salsa. This is a good choice because it doesn't involve cooking, and includes a number of imported ingredients. (Don't forget the chips.) Find a salsa recipe you like or make one up.
- Soups or stews. There are many recipe options for these dishes, which may give an opportunity to include a locally based meal to compare with the long-distance meal. There is also a possibility of including a soup or stew important to First Peoples, or one that is significant to another cultural group represented in your classroom.
- Pizza or another flatbread type of recipe.

#### c. Buy or gather all the ingredients and note where they come from. For example, if the cumin is from Mexico and the tomatoes from California make note of that. Before class starts put all the ingredients on the table for each group along with the recipe.

#### d. Students can record how far the ingredients they used travelled. They should show the ingredients, their sources, and the approximate distant they travelled to reach your community. Use a blank map of the world to record information about their ingredients.

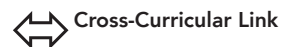

Cross-Curricular Link

Culinary Arts 10  
Food Studies 10

## UNIT 7 • CONNECTING FOOD SECURITY AND CLIMATE CHANGE

- Students could use a map of the world to illustrate the distances that the ingredients travelled. They can find the locations on a map and draw a line to your community, recording the ingredient and distance on the line. You could provide student copies of a map, or the class could plot the travel on a large classroom map of the world.
  - Finally have students add up all the distances relevant to their recipe to find out how far their ingredients have travelled in total to get to them.
- e. Students work in groups to make the recipe. Then they can share the food.
- f. Discuss the differences in the distances that the ingredients travelled, and how food distance impacts the food we eat. Some discussion questions are:
- What surprised you about how far our food travels?
  - How does our imported food get to our stores?
  - How much of our food do you think is imported from other countries?
  - What effect does the importing of food have on the climate and the environment?
  - Why is imported food often cheaper than local food?
  - What would happen if there is a trade war, natural disaster or political instability in the country where the food comes from?
- g. Discuss the cooking in terms of the food security of the ingredients.

### Activity 7.3

#### Traditional Foods and Food Security

---

Build on students' understanding of what traditional foods are and why they are significant. Students research local foods that First Peoples of the area have been harvesting and using for thousands of years.

It is best if this activity is specific to your location but if local resources are not available, you can focus on the broader region where you live. Connect with your school or district Aboriginal department, or local First Nations leaders to find out about local harvesting foods and techniques.

- a. Ask students to suggest or predict what traditional food resources are important for the First Nations of your region. Depending on your school location, there may be a spectrum of knowledge about local foods. Some students may be directly involved in food harvesting, while others may be very unfamiliar with what local resources are significant.
- Through consultation with your local First Nations support staff or local community, and through research, compile a list of local food resources.
  - If possible, display images of local food sources around the classroom. Have books available that describe local food sources, particularly books that deal with First Peoples foods.



#### Foundations

For information about inviting guest speakers into the class, see *Involving Local First Peoples Communities*, page 17.

## UNIT 7 • CONNECTING FOOD SECURITY AND CLIMATE CHANGE

- Students can refer to the First Nations Health Authority publication *Traditional Food Facts Sheets* for some of the important foods in BC. They will then need to determine which are found locally. Online at <https://bit.ly/2x5bCKc>.
  - Discuss what benefits there might be for eating traditional foods.
    - You may want students to refer to the article “Eating Healthy”: Traditional Foods Are Good Medicine For Both Body And Soul. First Nations Health Authority website. <https://bit.ly/2ExJIKk>
- c. Ask students to consider the four factors of food security in terms of traditional foods that First Peoples harvest from the land.
- Ask, how do these factors affect the ability of First Peoples to harvest food from their traditional territories?
    - Students can make notes on a new copy of Blackline Master 7-2, page 205, *Food Security*.
  - Sample responses:
    - Availability: There needs to be food to harvest. In some places that have not been harvested in years, the land is overgrown and plants are unproductive. Habitat loss can mean animals are not available to hunt. Some sources such as salmon have declined for a variety of reasons.
    - Access: People need to be able to get to the food. In some areas they may not be able to afford the technology to access the resources. People may be restricted from accessing private property that is on their traditional territories. Are there laws governing access to the resource?
    - Utilization: Are people able to process and store traditional foods using traditional or modern technologies? In some places the quality of the food resource may be affected by other sources such as pollution.
    - Stability: What outside forces could affect the supply of traditional foods from the land? For example, construction projects such as pipelines or dams; climate change; transportation such as tankers, ferries, trucks or railways.
  - You could select a common traditional food to apply as a model to the four factors of food security in a class discussion. For example, salmon is a significant fish for many First Peoples communities. Students can assess how secure salmon is as a food source now and in the future.
- d. Assessing local food security. Students can choose one traditional food source to determine how secure it is as a food supply for First Peoples in the future. They can use the four factors to guide their study. Have students research one or more traditional foods to find out about the current status as a food source, and how secure a food supply it is.
- For example, is the food readily available for the First Nations community to access? Can it be harvested sustainably? Is it impacted by factors such as climate change, habitat loss, or other industrial pressures?

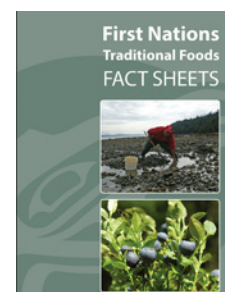

- Have students identify relevant vocabulary in the local First Nations language.
- Students can find out further information about the resource, including these features:
  - What the resource is.
  - If there are any restrictions on harvesting by the Provincial or Federal government (like clams, salmon, and hunting.)
  - If there are any Indigenous protocols around harvesting the resources.
  - How to identify the resource
  - How to harvest the resource
  - Recipes or ideas of cooking.
- Some students may be interested in investigating traditional foods from a different part of the province.
- Have students create a presentation to present the information they have found. They can choose a format such as poster, tri-fold pamphlet, digital project or other format.

## Activity 7.4

### Evidence of Climate Change in the Local Region

---

Ask students to investigate the question “What can the Elders and other community members tell us about climate change in the local ecosystem?”

- a. Introduce or review the term Traditional Ecological Knowledge.
  - Give some examples, and ask students if they know of any examples from people in their community. (See Unit 1, Activity 1.1 and Unit 5, Activity 5.2 for more ideas.)
- b. Ask Elders and knowledge-keepers to share their observations about the local environment that may be caused by climate change.
  - You may want to have one or a small group of speakers come to the classroom, or meet at a community centre with the students.
  - Alternatively, you may want to have students work in groups to interview an Elder or other community member, and report back to the whole class.
  - Work with students to develop questions to ask the speakers or interviewees. For example, they could ask questions such as:
    - How have weather patterns changed?
    - Have growing seasons changed? (Earlier/Later)
    - Do the foods they harvest taste any different or have different textures?
    - Are plants growing better, worse or the same?
  - For additional ideas about interviewing about climate change, see the activity Strangers in a Strange Land on the Canadian Wildlife Federation website. Link at <https://tinyurl.com/fnesc38>.

 **Foundations**  
For background to Traditional Ecological Knowledge, see Foundations, page 13

## UNIT 7 • CONNECTING FOOD SECURITY AND CLIMATE CHANGE

- c. If you are unable to arrange speakers or interviews, you may want to use some published interviews with elders. Some suggested resources are:
- Forests and Oceans for the Future, Unit 7 (<https://bit.ly/2DGpg91>). Gitxaała Elders and knowledge-keepers are interviewed about their observations of the effects of climate change.
  - *River of Salmon Peoples* includes many useful discussions and memories about salmon and the Fraser River, and how the salmon resources have changed over time. Some examples are:
    - page 62, Nle'kepmxcin
    - pages 66-67, Dakelh and Tsilhqot'in
    - page 105, Nle'kepmxcin
- d. Students can look for current news items that report on noticeable impacts of climate change in the local region.
- e. As a class, construct a chart showing some of the evidence for climate change.

### Activity 7.5

## Carbon Transformations

---

Students view the carbon cycle from an Indigenous perspective, using the themes of interconnectedness and transformation. They will discover how the carbon cycle plays a role in the interconnectedness of all things through its many transformations, and how human activity in recent history has caused the balance in the carbon cycle to shift causing climate change.

Background: Carbon is one of the most important building blocks of life. It is an element that links nearly all biotic and abiotic substances on earth. Through the carbon cycle, it is continually being transformed. Carbon is one of the most essential components of our ecosystem, yet an excess of carbon in the wrong place can have catastrophic results.

- a. Carbon is everywhere. Ask students to identify objects in the classroom that do not contain carbon. You may want to discuss or explain that all organic materials and plastic materials contain carbon.
- Have students find evidence to prove that the objects they identified do not contain carbon.
- b. Ask students if they know how carbon is related to climate change. You can record their responses on chart paper to refer to later.
- c. To find out more about the carbon cycle and climate change, students can view the video *What's the Deal with Carbon*. Bell Museum 2010. 3.03 min. Online at <https://youtu.be/2Jp1D1dzxj8>.



d. Becoming a Carbon Atom

In this activity, students become carbon atoms and set off on a transformational journey to different stations that represent locations where carbon can be found.

- If possible, do this activities outdoors. Each station can be set up in different parts of the school grounds or a nearby park. Where possible, set up a station near a location that is connected to its topic. For example, the Soil station could be near a site that has exposed soil.
  - If it is not possible to use the outdoors, it can be conducted in the classroom or other indoor space.
- Introduce the activity with Blackline Master 7-3, page 206, *A Carbon Journey*. You could make copies for students, read the directions or paraphrase them.
- At each station place one regular die and one of the carbon transformation option cards found on Blackline Master 7-4, page 207, *Carbon Transformation Stations*. Students roll the die to determine what happens next on the carbon transformation journey.
  - Alternatively, if you don't have enough dice, you could prepare the options for each station on slips of paper that students draw at random from a container such as a bag or envelope.
- Time permitting, conduct the activity twice. First use the Pre-Industrial Option for Station 7, Coal, Oil and Gas. This represents the carbon cycle under traditional resource use. Later use the Post-Industrial Option for Station 7, which represents contemporary industrial uses of fossil fuels.
- Discuss with the students the transformations that their carbon atoms went through while on their journey.
  - Were there places where a large number of carbon atoms collected and were stored for a long time? (Introduce or discuss the term *carbon sinks*)
  - What locations did they remain in for only short periods of time?
  - If they conducted the activity with both options, discuss the differences between the two. (Traditional uses option carbon stays stored in oil, coal and gas for a long time whereas in contemporary times, carbon is stored in large quantities in the atmosphere.)
- Students can make a visual representation of their carbon atom's journey. They could make a chart to show who went were, what the most common location was or what their favorite place was. Encourage students to share details about what they imagined they felt or saw at each location.

e. Discuss the differences of how traditional land and resource use impacted the carbon cycle (and by extension climate change) in comparison to how modern/ industrial land and resource use (including extraction of fossil fuels for energy use) impacts the carbon cycle.



Consider conducting the Becoming a Carbon Atom activity outdoors.

Blackline Master 7-3, page 206, *A Carbon Journey*

Blackline Master 7-4, page 207, *Carbon Transformation Stations*

See an online simulation of this activity at <https://bit.ly/2DoJ7Kv>



## UNIT 7 • CONNECTING FOOD SECURITY AND CLIMATE CHANGE

- f. Students can explore how one BC First Nation is helping to remove carbon from the atmosphere.
- See the CBC news article “In fight to combat climate change, Squamish Nation joins forces to capture carbon” by Angela Sterritt, CBC 2018. Linked at <https://tinyurl.com/fnesc71>.
  - Students can find out the technology that the Squamish Nation will use to capture carbon.
- g. Students can revise the Becoming a Carbon Atom activity to incorporate actions to capture carbon. This could include the technology used by the Squamish Nation, and the movement to plant a trillion trees. See the Carbon Sequestration activity in Unit 8, Activity 8.7-f.
- Students can create a new station, “Carbon Capture.”
- h. One Minute Essay. Have students work individually for one minute to write an answer to the question: What was the main point of the Carbon Journey Activity?

 **Formative Assessment Strategy**

Use the One Minute Essay to assess students’ understanding of the significance of the carbon cycle.

### Activity 7.6

## Albedo and Climate Change

---

In this activity students will learn about surface albedo and its effect on global temperatures. That understanding will then be applied to understanding how human activities are changing the amount of solar radiation being absorbed by the earth’s surface.

- a. What is albedo? Review or introduce the concept of albedo.
- Ask students if they think it is more comfortable to wear light or dark clothing on a hot sunny day. Similarly, discuss the differences when walking barefoot on a sunny day on blacktop, a sandy beach, or on the grass. Ask students to suggest reasons for the differences.
  - Through the class discussion, you can assess students’ level of understanding of radiant energy and how it is absorbed or reflected.
  - Discuss the term “albedo.”
- b. Have students work in groups to design a lab demonstration that will illustrate the effects of the sun’s rays on different coloured surfaces.
- Groups could begin by having a general discussion about how they could design the lab demonstration. They can suggest what materials they could use to show the sun’s effects on different surfaces.
  - If students require more structure you can provide them with the procedure for a simple way of conducting the demonstration:
    - Fold squares of black and white construction paper into pockets. Staple two sides leaving one end open.

 **Lab Activity**

 **Formative Assessment Strategy**

Assess the group’s plans for their demonstration and provide support where needed.

## UNIT 7 • CONNECTING FOOD SECURITY AND CLIMATE CHANGE

- Put the bulb end of each thermometer into a pocket
- Put the thermometers directly under the desk lamp so they both get the same amount of light
- Record the starting temperatures without the light, then record the temperatures every two minutes for a total of 10 to 20 minutes.
- You can have students find their own materials, or you can provide some basic materials for students to use. These could include:
  - 2 thermometers for each group
  - desk lamp with incandescent light bulb
  - black and white construction paper
  - scissors
  - stapler
- Have groups describe their lab demonstration. It should include a hypothesis or prediction of what their results will be, the materials used, a list of steps they will carry out, and a way of recording the data they collect.
- Have students analyse the data.
  - Calculate the temperature change for each colour
- Ask students to make a generalization about what their demonstration shows.
- For a different approach to this activity, see Looking Into Surface Albedo, UCAR Center for Science Education, linked at <https://tinyurl.com/fnesc39>. In this version, students put the thermometers under a colour photograph of a landscape that includes a glacier. This could be adapted to use colour images from the local region.



### Land-Based Activity

#### Measuring Albedo

- c. Measuring the local albedo of different surfaces. Students go outside and determine the relative albedo of a number of different surfaces.
- Explain the purpose of the activity, to measure the albedo of 10 different area around the school (or other locations you plan to visit).
  - Before going outside, students can list ten different surfaces they expect to find. For example, open grass area, concrete, dirt, stone, metal object such as a car, wood, asphalt, gravel, in the shade of a tree.
  - Explain the procedure students should follow when they measure the albedos of different surfaces.
    - Set the thermometer about 5 cm about the surface. Students can design a stand that will hold it in place at a standard distance from the ground and without being affected by the body heat
    - Discuss why the thermometer is not placed directly on the surface. (Because you are measuring radiant heat energy)
    - Shade the thermometer from direct sunlight above. Discuss why this is important. (So it is the radiant heat that is warming the thermometer, not the direct sunlight.)
    - Wait two minutes then read and record the temperature.

### g. Albedo and Climate Change

What types of surfaces are located in the local area (black asphalt, green forest canopy, blue lake water/ocean water, white snow cover, etc.)

- Discuss what human activities are affecting these surfaces. If so what affect would that have on temperature?

## Activity 7.7

### Ecosystem Inquiry

---

Students can study one type of ecosystem to see the relationships between food security and climate change that are specific to that ecosystem. Have students select an ecosystem that interests them, and develop an inquiry question. Some examples include:

- a. Climate Change and Food Security in Freshwater Ecosystems
  - Students focus on how changes in water systems affects food security, including factors such as:
    - flooding
    - water temperature
  - Refer to the activities in Unit 3, Relationships to Fresh Water.
- b. Climate Change and Food Security in Marine Ecosystems
  - Students focus on how changes in the marine ecosystems affect food security, such as:
    - changing seasons
    - acidification
    - water temperature
    - big tides and storms
  - Refer to Unit 8, Ocean Connections in Science First Peoples 5-9 (FNESC). See Activity 5, Ocean Case Study: Ocean Acidification and Hypoxia, page 184.
  - See *Exploring the Great Bear Sea, Environmental Science 11, 12*; Case Study 3: Pacific Herring. This case study examines changes in the spawning behaviour of the herring, observed by the Kitasoo/Xai'xais First Nations. <https://greatbearsea.net/environmental-science/>
- c. Climate Change and Food Security in Forest Ecosystems
  - Students focus on how changes in forest ecosystems can impact food security of traditional foods.
  - See Unit 8, Forests and First Peoples, Activities 8.7, Carbon Sequestration in Trees, and 8.8, Tracking Historical Forest Fires.

## Activity 7.8

### Caribou and Climate Change

---

Students will investigate how the impacts of climate change on caribou affects food security for First Peoples who rely on it.

**Background:** This activity explores the impacts of climate change as it relates to caribou. The caribou is a culturally important species to First Peoples who have access to it, both as a food source and a provision for a variety of uses. All parts of the caribou are used, including meat, marrow, sinew, hide, antlers, tallow, fat and blood.

Climate change is disrupting caribou migration routes. For example, longer and warmer summers result in an increase in parasitic flies which torment caribou. Depending on the location, changes in vegetation growth could impact the diet of moss and lichen availability.

- a. Have students research the various species of caribou in British Columbia and other parts of Canada. Ask them to find out which of these species are threatened or endangered.
  - Students will be able to readily find general information about caribou in books or online.
    - One good resource to start with is the BC government brochure Caribou in British Columbia. Access at <https://bit.ly/2DiMHWT>.
    - As well, the BC Government web page about caribou gives a summary of the different BC types, including maps of their habitat. <https://bit.ly/2BVB1rt>
    - *Project Caribou. An Educator's Guide to Wild Caribou of North America* (2001) provides detailed information about caribou. Linked at <https://tinyurl.com/fnesc37>.
  - Have students work in groups to research ecological information about the types of caribou in BC. It will also be of interest to include the Barren-Ground caribou of the Arctic, as they are the caribou that are most commonly portrayed, especially their large populations and striking migrations. Note that the way scientists classify caribou types has changed, so students may find sources with different groupings. The types of caribou to research are:
    - Boreal Caribou
    - Central Mountain Caribou (formerly included in the “northern caribou”
    - Northern Mountain Caribou (formerly part of the “northern caribou”
    - Southern Mountain Caribou (formerly the “mountain caribou”
    - Barren-Ground Caribou (not found in BC)

## UNIT 7 • CONNECTING FOOD SECURITY AND CLIMATE CHANGE

- Students can use Blackline Master 7-5, page 209, Caribou Data File to record their data, or create their own graphic organizer or way of recording the information.
  - After they have collected their data, students could work in a Jigsaw activity to share their information with the other students. Students can then compare the different types and summarize their similarities and differences.
- b. Discuss or have students research some ways that caribou interact with their environments. Ask questions such as:
- What type of diet or migratory pattern do caribou use?
  - Why would the migration patterns be an issue for caribou survival?
  - Why would the flies be an issue for caribou?
  - Is an increase in vegetation due to the longer and warmer summer months an issue for caribou?
- c. Caribou Activities. The online guide *Project Caribou. An Educator's Guide to Wild Caribou of North America* (2001) has a number of engaging activities that students can participate in. Link at <https://tinyurl.com/fnesc37>. They include:
- Barren-ground caribou migration (pages 33-37). Students participate in an active game that demonstrates how hunting and predation affect caribou populations.
  - “Ya gotta lichen caribou” (pages 101-103). This is physically active simulation in which students act as herds of caribou competing for water, food and space in an environment that changes as the game proceeds. The activity can take place in a gym or outdoors.
- d. Have students research to find out how caribou are significant to many First Peoples cultures. Ask them to find out how caribou are traditionally used.
- e. Students can use iMapBC to determine caribou distribution across British Columbia. For full instructions on how to use iMapBC, see Blackline Master 8-2, page 226, Mapping Historical Fires in Unit 8. Here are the basic steps for locating the caribou distribution data:
- With the iMapBC page open, click on the “I want to...” button at the top of the map.
  - Select Add Provincial Layers
  - Select Fish Wildlife and Plant Species
  - Select Caribou distribution
  - Select both Outlined and Colour Themed options.
  - Students may need to zoom in on the map to see the names of the various caribou herds.
  - Have students find out which species are distinct to a First Nations group. Determine locations of First Nations communities and reserve lands within the designated caribou regions of BC.

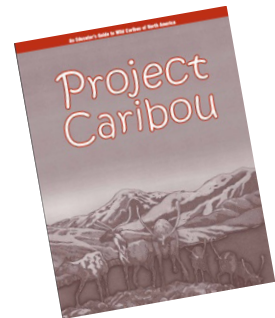

## UNIT 7 • CONNECTING FOOD SECURITY AND CLIMATE CHANGE

- e. Have students find out how climate change impacts the caribou.
- Some impacts are:
    - uncertainty - long-term effects unknown
    - weather variability, severe weather events
    - severe wildfires
    - more freeze-thaw cycles
    - more freezing rain, deep snow hot summer temperatures
    - changes in forest composition
    - food supply
    - shift in timing and length of seasons
    - earlier spring thaws and later freeze-ups
    - changes in habitat
    - Climate change favours deer and prey species, which expand into caribou ranges; more deer means more predators; more predators means more caribou killed.
    - habitat change for caribou, such as if the boreal forest shifts northward
    - spreading northward of forest insects which kills trees - mountain pine beetle.
- f. Students can investigate how First Peoples and wildlife scientists are collaborating on the management of caribou and their habitat.
- See for example the article “Governments of Canada and British Columbia to collaborate with First Nations on recovery of Southern Mountain Caribou” 2018, <https://tinyurl.com/fnesc68>.

### Activity 7.10

## First Nations Communities Adapt to Climate Change

---

Students can investigate how First Peoples are adapting to climate change by combining traditional knowledge and modern technology. This can include food security and other concerns.

- a. Students can work in groups to investigate measures that a number of BC First Nations are undertaking to combat and adapt to climate change. First they will need to identify some First Nations who are actively working to adapt to climate change. Here are some examples:
- Kanaka Bar. The T'eqt'aqn'mux people of the Kanaka Bar Indian Band on the Fraser Canyon, part of the Nlaka'pamux Nation.
    - The Kanaka Bar Band has a page on their website devoted to their climate change strategy: <http://www.kanakabarband.ca/climate-change>. Students should make sure they explore the links on the right sidebar.

## UNIT 7 • CONNECTING FOOD SECURITY AND CLIMATE CHANGE

- See the online article, Kanaka Bar four steps ahead of climate change (National Observer 2018) Linked at <https://tinyurl.com/fnesc69>.
  - T'Sou-ke First Nation
    - Video: T'Sou-ke Food Security. Channeldown2earth, 2010. 6:04 m. <https://youtu.be/f5I4Ooqd7Nw>.
    - Article: “How First Nations in Canada are addressing climate change – “This is power to the people – literally and metaphorically.” by Rod Janssen. Energy in Demand (energyindemand.com), 2018. <https://tinyurl.com/fnesc70>.
  - Kitsumkalum: See resources under Activity 7.1-e.
  - Squamish: See the article about the Squamish Nation and carbon capture in Activity 7.5-f.
- b. Students can examine the resources to find out what actions are being taken by First Nations communities to combat and adapt to climate change
- Students can create a chart of different types of actions taken by First Nations. They could identify which work towards food security and which deal with other factors.
- c. Students can suggest other ways that First Nations can adapt to climate change to mitigate the effects on food security. Suggest students look back at the four aspects of food security on Blackline Master 7-2, page 205.
- For example:
    - reviving traditional knowledge
    - renewing traditional harvest sites
    - growing local foods in community gardens
    - sharing, trading foods

### Activity 7.11

#### Companion Planting: An Indigenous Model

In this activity students examine a traditional method of agriculture used for thousands of years by First Nations in eastern North America, known as the Three Sisters. Then they see a contemporary version of companion planting called a Food Forest.

- a. The Three Sisters. The Three Sisters refers to the traditional companion planting of three vegetable: corn, squash and beans. This practice was developed by Indigenous farmers in eastern North America long before contact. It is an excellent example of Indigenous scientific knowledge, and could be a model for people to use to adapt to climate change.
- Have students read the story of the Three Sisters. There are several versions of the story told by different Indigenous groups of eastern Canada and the USA.

## UNIT 7 • CONNECTING FOOD SECURITY AND CLIMATE CHANGE

- The Three Sisters: The Haudenosaunee's Three Sisters.  
<http://www.oneidaindiannation.com/the-legend-of-the-three-sisters/>
  - The Iroquois Legend of the Three Sisters. (in a diabetes program newsletter.)  
<https://bit.ly/2D9GMDC>
  - The Three Sisters. This curriculum package includes three short versions of the narrative. See pages 2 and 3. <https://bit.ly/2CwEA70>
- b. Have students discuss the Indigenous knowledge inherent in the planting of beans, corn and squash. For example, Indigenous people understood that the leaves of the squash helped control the moisture of the soil.
- Have students explain how the three plants work together with each other. Ask, What does each plant give and receive? If students need to, they can research further to find out the important relationships between the three plants.
  - They can draw a diagram that illustrates the relationships of the three plants.
  - The main relationships include:
    - Corn stalks support bean vines
    - Beans provide nutrients (nitrogen) for the corn
    - Squash leaves provide cover which helps retain moisture and prevents weed growth between the mounds.
- c. If you haven't discussed it so far, tell students that this farming technique is called companion planting. Discuss why it is called that.
- Explain that companion planting is an old way of making the most out of a small area to plant, while also providing a balance of nutrients for plant growth and pest control. Crop rotations and cover crops improve these issues by managing the system to benefit the soil and crop. Mixed planting, or inter-cropping, of one or more plant species can help provide this kind of diversity.
- d. Additional videos that students could watch are:
- Appreciating the Three Sisters. 7:25 min. Produced 1995. (uploaded 2016). Youtube [https://www.youtube.com/watch?v=pb8ANVAhj\\_8](https://www.youtube.com/watch?v=pb8ANVAhj_8)
  - Bertha Sky, 3 Sisters Soup. Factory Media Centre, 2017. 3.28 min. <https://youtu.be/bgineteFOOg>.
  - Three Sisters Garden. 3.27 min. (made for young children.) <https://youtu.be/SQ4dgTwTpvk>.
- e. Students can investigate a recently developed system of ecologically-based agriculture which involves companion planting. Permaculture, a word coined in 1978, is a holistic approach to food production which aligns with many Indigenous practises and concepts. Permaculture is built on three main ideas: care for the earth, care for the people, and fair share.
- One of the main features of permaculture is a system of planting called a food forest. It is designed to model the biodiversity of a natural forest using many plants that produce food.



## UNIT 7 • CONNECTING FOOD SECURITY AND CLIMATE CHANGE

- Introduce the concepts of permaculture and food forests. You could use direct instruction, or have students research to come to an understanding of what they mean. There are many resources about both permaculture and food forests online. Here are some suggestions to start with.
  - “What is Permaculture?” Permaculture Research Institute website. <https://permaculturenews.org/what-is-permaculture/>
  - *A Forest Garden With 500 Edible Plants Could Lead to a Sustainable Future*. National Geographic, 2019. 3.23 min. This UK-based video gives a quick overview of food forests and their attributes and purposes. It shows a large woodlands food forest. [https://youtu.be/Q\\_m\\_0UPOzuI](https://youtu.be/Q_m_0UPOzuI).
  - *Urban Food Forest Tour (Canada’s Oldest): Spring Ridge Commons*. Edible Landscapes Design, 2017. An urban food forest example in Victoria, BC, which is a contrast to the large forest shown in the above video. <https://youtu.be/CLJlsR7U8uc>.
- Students can create a list of some of the important attributes of a food forest. (For example, they are sustainable, they use companion planting, they encourage biodiversity, pests are controlled naturally, they are highly productive, they are designed using natural layers found in forests.)
- Have students identify the seven layers of a forest that food forests are built on. They can draw a diagram to show the layers.
  - The layers are canopy or tall-tree layer, low tree layer, shrub layer, herbaceous layer, root layer, ground cover layer, vertical or vine layer.
  - Here are two online diagrams that can be used as references: <https://tinyurl.com/fnesc87>; <https://tinyurl.com/fnesc88>.
- f. Discuss how food forests could be used to improve food security in response to the effects of climate change, particularly in Indigenous communities.
  - This webpage describes how the Muskeg Lake Cree Nation in Saskatchewan uses food forests to help ensure food security for their people. “What’s a food forest?” at the Canadian Feed the Children website, linked at <https://tinyurl.com/fnesc85>.
- g. Students can design and create a food forest plan that could work in their area.
  - You may want to share a project involving BC secondary school students as partners in a First Nations forest garden. See “Coquitlam school partnership to create First Nations forest garden,” Diane Strandberg, Tricity News, 2017. <https://tinyurl.com/fnesc89>
  - Students’ food forest designs could include traditional plants as well as new ones that could now live in the area.
  - Students could draw and label a diagram of their food forest, or create a 3-D model of it.

## Activity 7.13

### Developing a Proposal to Address Local Climate Changes Issues.

---

In this activity, students will develop a proposal that could be submitted as part of the First Nations Adapt program put forth by the federal government to address local issues around climate change. First Nations communities have the opportunity to propose projects designed to mitigate the effects of climate change on such things as food security, road access, flooding and coastal erosion.

- a. Reflecting on the in-class discussions, guest speakers and other resources presented throughout this unit, brainstorm local climate change issues that affect the community either in terms of infrastructure (roads, housing, etc.), economy (tourism, resource management, etc.), culturally, access to traditional food sources or in any other way.
- b. Guide the class through the First Nations Adapt Program website, <https://bit.ly/2DD2q1q>. Cross reference the list of issues brainstormed during class against the “Program Areas: prioritized program areas”
  - Do any local issues match the program priorities? Choose one that does match or is as close as possible to a match. There are also a list of project examples on the web site to get an idea of what to focus on.
- c. As a class, focus the issue into a specific problem that affects the community in terms of the matter chosen by the class. Some examples might include:
  - Access to the community is reduced during the spring months due to increased flood levels. The number of days during the year where the road is flooded has been steadily increasing over the last \_\_\_\_ years.
  - Fish and game numbers in the area have steadily declined over the last \_\_\_\_ years and our community depends on these resources for cultural and nutritional reasons.
  - The website also contains examples of projects and a list of prioritized areas.
- d. Divide the class into discussion groups with the simple task of answering the question “What solutions can you think of for this issue?”
  - There should be no restrictions on the resources student minds can use in solving this problem. The understanding is, at this point, the funding will be in place. The solutions can include unlimited human resources, machinery or technology. Creativity is the key during this stage.
  - Each group will create a class presentation around their solution and present to the class. The class will have to choose one of the presented solutions to move forward with so it is important for the audience to consider each presentation carefully.

## UNIT 7 • CONNECTING FOOD SECURITY AND CLIMATE CHANGE

- e. Each student will rank the solutions in terms of practicality, cost, length of time required, effectiveness at solving the issue,
- Teacher will compile the results. The solution that is most consistently ranked highest by students will be chosen as the class solution.
- f. Research: Once the class solution is decided upon, the class will be divided into groups tasked with researching various aspects of the proposal. These groups will be given tasks to complete sections of the proposal outlined by the website.

Other group topics could include:

- History of the issue: what data does the community have around the history of the issue? How has life in the community been affected by this issue?
  - Future prospects: If left unchecked, how will this issue impact the community in 10 years? 20 years?
  - Cost: As best as can be done, estimate the cost of the implementing this solution. How many people will this require? How many hours of work? What equipment or technology is required?
  - Procedure: What steps are required to implement this solution? Break down the process in a detailed, step by step description of events.
- h. Real-life action. For schools in a First Nations community, this activity could become more than a class project. Depending on your local situation, students and the school could work together with the local First Nations government to submit a proposal to the program.
- The First Nations Adapt program emphasizes community support for projects as part of the approval process. Projects with the most support from communities will be more likely to be approved. Once they have decided on their proposal, the class will need to present their solution to Chief and Council. Any feedback from Chief and Council would be incorporated into the proposal.
  - Proposal ideas can be talked through by staff in the FNA program. Email questions to [aadnc.adaptation.aandc@canada.ca](mailto:aadnc.adaptation.aandc@canada.ca)
  - Once the proposal is complete and has been supported in some way by the community, students can submit the proposal.

## Food and Climate Change Discussion Questions

Food and Climate Change

Discussion question 1

Do you think climate change has an impact on the food you eat now? If so, in what ways?

Food and Climate Change

Discussion question 2

How do you think climate change will affect the availability of our food in the future? How might it impact the types of foods we eat and the sources of our food?

Food and Climate Change

Discussion question 3

How could climate change impact the foods that First Peoples and others who harvest some or all of their food from the land around them?

Food and Climate Change

Discussion question 4

How do you think climate change will affect the quality of our food in the future? Will it affect the nutritional value of our food?

# Food Security

Food security is the condition in which all people, at all times, have physical, social and economic access to sufficient safe and nutritious food that meets their dietary needs and food preferences for an active and healthy life.

(United Nations' Committee on World Food Security)

<p style="text-align: center;"><b>AVAILABILITY</b></p> <p>Is there enough food available? Is there a sufficient supply for the future?</p>	<p style="text-align: center;"><b>ACCESS</b></p> <p>Can people access the food? Can they get to it, or afford to buy it?</p>
<p style="text-align: center;"><b>UTILIZATION</b></p> <p>Can people make good use of the food? Is it good quality and nutritious?</p>	<p style="text-align: center;"><b>STABILITY</b></p> <p>How susceptible to local and global forces is the food supply?</p>

## Blackline Master 7-3

# A Carbon Journey



### **Carbon is on the move!**

All organic matter contains carbon. Those berries you ate for lunch? They were full of carbon gathered from the atmosphere transformed through the process of photosynthesis. You are full of carbon.

Every time you eat, you ingest carbon and when you exhale you release carbon in the form of carbon dioxide created through cellular respiration. When a living organism dies the carbon goes into the soil or back into the atmosphere. Sometimes, if carbon is trapped under ground for a very, very, very long time, it can become oil, coal or natural gas.

### **Becoming a Carbon Atom**

In this activity, you will take the role of a carbon atom and set off on a journey to different stations. The stations represent different locations where carbon can be found and stored.

At each station a random roll of dice will determine what happens next. Will you gain powers of invisibility as you are absorbed into the atmosphere? Will you be trapped for millions of years as oil or coal deep beneath the earth's surface or will you be swallowed by an animal only to be expelled a short while later?

Record your transformation in a Travel log. As you reach your destinations, take a minute to imagine what you would see while there and how you feel, then record what you see and feel in your travel log. Roll the dice and follow the directions on the sheet to move to the next location.

**Station 1 ATMOSPHERE**

1. You follow wind currents to the other side of the world. Stay in Atmosphere
2. You stay in the air. Stay in Atmosphere
3. You are taken in by a Devil's Club through photosynthesis. Go to Plants
4. You are dissolved in the Ocean. Go to Ocean
5. You are breathed in by a moose. Go to Animal
6. You remain in the air. Stay in Atmosphere

**Station 2 HUMANS**

1. The human respire and breathes you out as CO<sub>2</sub>. Go to Atmosphere.
2. Through digestion the human eliminates you into its waste water system. Go to Ocean.
3. The human sneezes and you are expelled into the air. Go to Atmosphere.
4. You are absorbed into the human's bone. Stay in Humans.
5. You are eliminated and processed in a waste treatment plant. Go to Soil.
6. You are consumed by a bacteria in the human's gut. Stay in Humans.

**Station 3 SOIL**

1. You stay in the soil as dead plant matter.
2. You stay in the soil as dead animal matter.
3. You are burned for fuel and released into the atmosphere. Go to Atmosphere.
4. You remain buried deep in the earth for millions of years, eventually becoming Coal Oil or Gas. Go to Coal, Oil and Gas.
5. You are taken up through a plant's roots. Go to Plants.
6. You erode into a river and eventually end up in the Ocean. Go to Ocean.

**Station 4 PLANTS**

1. You become part of the plant's structure. Stay in Plant.
2. You are burned for fuel and released into the atmosphere. Go to Atmosphere.
3. The plant you are part of is eaten by an animal. Go to Animal.
4. The plant you are part of dies and falls to the ground. Go to Soil.
5. You are eaten in a salad for lunch. Go to Humans.
6. You die and are compressed over millions of years. Go to Oil and Gas.

**Station 5 OCEAN**

- 1 You are carried by the ocean currents. Stay in Ocean
2. You are absorbed by plankton in the process of photosynthesis. You are eaten by a fish. Go to Animals.
3. You follow currents through the ocean, stay in Ocean.
4. You are released into the atmosphere. Go to Atmosphere.
5. You are absorbed by phytoplankton in the process of photosynthesis. You are eaten by clam, which is then eaten by a human. Go to Humans
6. You are absorbed by a salmon who is caught by a bear when it is spawning. The bear drops the carcass in the forest by some trees. Go to Plants.

**Station 6 ANIMAL**

1. You become part of the animal's body. Stay in Animal.
2. You are released as waste through respiration when the animal breathes out. Go to Atmosphere.
3. The animal you are part of is eaten by another animal. Stay in Animal.
4. The animal you are part of dies and falls to the ground. Go to Soil.
5. The animal you are part of dies and decomposes, you are released into the atmosphere by the microbes decomposing the animal. Go to Atmosphere.
6. The animal you are part of is dinner for a Human. Go to Human.

**Station 7 COAL, OIL, AND GAS - Pre-Industrial**

1. You remain buried deep in the earth for millions of years. Stay in Coal, Oil and Gas.
2. You remain buried deep in the earth for millions of years. Stay in Coal, Oil and Gas.
3. You remain buried deep in the earth for millions of years. Stay in Coal, Oil and Gas.
4. You remain buried deep in the earth for millions of years. Stay in Coal, Oil and Gas.
5. You remain buried deep in the earth for millions of years. Stay in Coal, Oil and Gas
6. You are burned for fuel and released into the atmosphere. Go to Atmosphere.

**Station 7 COAL, OIL, AND GAS - Post-Industrial**

- 1 You remain buried deep in the earth for millions of years. Stay in Coal, Oil and Gas.
- 2 You remain buried deep in the earth for millions of years. Stay in Coal, Oil and Gas.
3. You are burned for fuel and released into the atmosphere. Go to Atmosphere.
4. You are burned for fuel and released into the atmosphere. Go to Atmosphere.
5. You are burned for fuel and released into the atmosphere. Go to Atmosphere.
6. You are in an oil spill and leak into the ocean. Go to Ocean.



Blackline Master 7-5  
**Caribou Data File**

Caribou Types	Location	Ecological Relationships	Principal Foods	Population
Boreal Caribou				
Central Mountain Caribou				
Northern Mountain Caribou				
Southern Mountain Caribou				
Barren-ground Caribou				



# Unit 8

## FORESTS AND FIRST PEOPLES

### Overview

For us, the forest is like a church – it is where we can stay connected to the natural world – a place of balance, harmony and spirituality. (Lil'wat First Nation)\*

Forests dominate the British Columbia landscape, so it is not surprising that First Peoples have had, and still have, an intricate relationship with the forests.

Forests are the protectors of the diversity of life found within. For First Peoples forests have provided sustenance in diverse forms, from shelter, clothing, hunting and trapping to harvesting roots, berries and more.

Trees, and the forested lands they share with flora and fauna, are culturally significant and sacred to First Peoples. This unit focusses on some of the major significant trees found in the province. It includes a special look at cedar, one of the most important trees.

### *Guiding Questions*

- How do significant trees impact the cultural, social, economic and political lives of First Peoples?
- How do First Peoples apply Traditional Ecological Knowledge and scientific knowledge of physical and chemical properties to the use of trees and their ecosystems?
- In what ways can we identify and classify trees?
- What role can trees play in dealing with climate change?

---

\* <https://www.whistler.com/blog/post/2011/12/26/lilwat-nation-culturally-modified-trees/>

## Relevant BC Learning Standards for Senior Secondary Science

Course	Key Content Standards	Key Curricular Competencies
Life Sciences 11	<ul style="list-style-type: none"> <li>• First Peoples understandings of interrelationships between organisms</li> <li>• First Peoples knowledge on classification</li> </ul>	<p><b>Questioning and predicting:</b></p> <ul style="list-style-type: none"> <li>• Make observation aimed at identifying their own questions, including increasingly abstract ones, about the natural world.</li> </ul>
Environmental Science 11	<ul style="list-style-type: none"> <li>• Ecosystem complexity: roles; relationships; population dynamics</li> <li>• Energy flow through ecosystems</li> <li>• Matter cycles through and between living systems</li> <li>• Succession</li> <li>• First Peoples knowledge and other traditional ecological knowledge in sustaining biodiversity</li> <li>• Benefits of ecosystem services</li> <li>• Human actions and their impact on ecosystem integrity</li> <li>• First Peoples ways of knowing and doing</li> <li>• Resource stewardship</li> <li>• Restoration practices</li> </ul>	<p><b>Planning and conducting:</b></p> <ul style="list-style-type: none"> <li>• Collaboratively and individually plan, select and use appropriate investigation methods, including field work and lab experiments, to collect reliable data.</li> </ul> <p><b>Processing and analyzing data and information:</b></p> <ul style="list-style-type: none"> <li>• Experience and interpret the local environment</li> <li>• Apply First Peoples perspectives and knowledge, other ways of knowing and local knowledge as sources of information</li> </ul> <p><b>Evaluating</b></p> <ul style="list-style-type: none"> <li>• Consider social, ethical, and environmental implications of the findings from their own and others' investigations</li> </ul>
Environmental Science 12	<ul style="list-style-type: none"> <li>• Soil characteristics and ecosystem services</li> <li>• Land use and degradation</li> <li>• Land management</li> <li>• Personal choices and sustainable living</li> <li>• Global environmental ethics, policies and law [including First Peoples perspectives, philosophies and responsibilities]</li> </ul>	<p><b>Applying and innovating:</b></p> <ul style="list-style-type: none"> <li>• Contribute to finding solutions to problems at a local and/or global level through inquiry</li> </ul> <p><b>Communicating:</b></p> <ul style="list-style-type: none"> <li>• Express and reflect on a variety of experiences, perspectives, and worldviews thorough place.</li> </ul>
Chemistry 11	<ul style="list-style-type: none"> <li>• Organic compounds</li> <li>• Applications of organic chemistry</li> </ul>	

## Resources

For further information on these resources, see the annotations in the Bibliography, beginning on page 273.

### Suggested Resources

- An example of a dichotomous key
- Lab materials for Activity 3
  - Agar plates
  - Loops with bacterial samples OR collect your own samples
  - Cedar oil (essential oil obtained by steam extraction)
- British Columbia. iMapBC application BC Government website, linked at <https://tinyurl.com/fnesc28>
- Biomass calculator, Natural Resources Canada website, <http://bit.ly/2dKs4H6>
- Parish, Roberta. *Tree Book: Learning to Recognize Trees of British Columbia*. Partnership Agreement on Forest Resource Development. Print version, or download online at <http://ow.ly/7DLO302Wa1h>.
- Stewart, Hilary. *Cedar: Tree of Life to the Northwest Coast Indians*. Douglas & McIntyre, 1984.

### Additional Resources

- *Bark Peeling*. Hartley Bay School 2015. 2:44 min. <https://youtu.be/YxuS6Qk8nzk>.
- *Bill Reid*. NFB 1979. 27:56 min. [https://www.nfb.ca/film/bill\\_reid/](https://www.nfb.ca/film/bill_reid/)
- CBC. “Best way to fight climate change? Plant a trillion trees. 2019, linked at <https://tinyurl.com/fnesc33>.
- Journey into Time Immemorial. Interactive website. SFU Museum of Archaeology and Ethnology 2009-2009. <https://tinyurl.com/fnesc34>.
- Turner, Nancy J. *Plant Technology of First Peoples in British Columbia*. Royal BC Museum, 2007.
- *Spruce Pitch Glue*. Online at <https://youtu.be/l3Fyl7NFnO0>.
- *The Story of Cedar* (Sechelt Arts Fest 2015). 26 min. Blue Zula, 2015. <https://youtu.be/WlCt9Jx0T7g>

### Blackline Masters

- 8-1 Culturally Significant Trees of BC
- 8-2 Tree Classification
- 8-3 Petri Dish Mapping
- 8-4 Using a Biomass and Nutrient Calculator
- 8-5 Mapping Historical Forest Fires in British Columbia

## Outline of Activities

- 8.1 Culturally Significant Trees
- 8.2 Identifying trees
- 8.3 Tree Stories
- 8.4 Cedar: Tree of Life
- 8.5 Cedar Oil as an Antibiotic
- 8.6 Making Pine Pitch Or Spruce Glue
- 8.7 Carbon Sequestration in Trees
- 8.8 Tracking Historical Forest Fires

## Suggested Activities

Note: There are more activities here than most teachers will incorporate into their units. It is not expected that you will use all of the activities, or follow the sequence as it is described. These activities are intended to be adapted to fit the needs of your students and classroom, as well as inspire ways that you can respectfully include relevant Indigenous knowledge and perspectives in your course.

## Activity 8.1

### Culturally Significant Trees

---

All trees are important in some way to First Nations cultures who share their habitats, but some trees play a more central role. In this activity students investigate one or more significant trees and their roles in all aspects of life for First Nations. Students will develop an awareness of the depth of connections First Peoples have always had with trees

- a. Begin with a story. Find a narrative that demonstrates a connection with a specific tree, or trees in general. You may want to focus on a significant tree from your region.
  - For two short examples, see *Cedar*, Hilary Stewart, page 27.
- b. Forest Walk. If possible, take a walk through a forest or a neighbourhood area with trees. Ask students to notice different parts of the trees. How much diversity do they see?
  - Students can observe the five senses as they walk through the forest.
  - Discuss the interconnections that the trees have with other flora and fauna in their habitat.

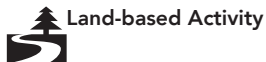

Forest Walk

## UNIT 8 • FORESTS AND FIRST PEOPLES

- c. Ask students, What personal connections do you have with trees? Students can share experiences and knowledge about trees in the local environment.
- They could write a reflection piece on their connections with trees. Ask questions such as:
    - Are there any trees that are special to you or your family?
    - How do you feel around trees?
    - How important are trees to you? To the world?
- d. What are culturally significant trees? Ask, What are culturally significant trees for First Peoples in your local region? What are culturally significant trees for First Peoples in other parts of the province? Discuss what might make a certain species of tree culturally significant.
- e. Students can use Blackline Master 8-1, page 225, *Culturally Significant Trees of BC* to familiarize themselves with some culturally significant trees for First Nations.
- Have students work in pairs to discuss the trees that they are familiar with, or know something about.
  - In their pairs, students can find out one or two reasons why each of the trees is significant to First Peoples. They can use the *Tree Book* or another source to find the information.
  - If possible, have pictures of the trees to display in the class.
- f. If possible, have a local First Nations Elder or knowledge-keeper visit the class to talk about some aspects of a significant tree and its importance to First Nations.
- g. Discuss other ways that trees could be significant. For example, in BC we have a number of economically significant trees. Ecologists may identify other trees as being most significant to certain ecosystems. Gardeners or landscape designers would have a different perspective on what trees are significant.

 Blackline Master 8-1, page 225, *Culturally Significant Trees of BC*

 *The Tree Book: Learning to Recognize Trees of British Columbia*  
In print or online at <http://ow.ly/7DLO302Wa1h>

## Activity 8.2

### Identifying Trees

---

Students consider ways that people identify trees from different perspectives.

- a. Ask students how they could help someone find a certain species of tree in the forest if they didn't know its name. What features could they look for? How would they be able to tell them apart from other trees?
  - Discuss what type of knowledge they would need to have to help someone find a tree.
- b. Have students design a method that someone could follow to identify a specific tree. It may be best to focus on one of the significant trees. Here are some possible approaches.
  - Have students compare two different trees. They could be similar, such as cedar and hemlock, or cottonwood and alder; or dissimilar such as black spruce and maple. What characteristics do they share? How do they differ?
  - A tree hunt. Have students create clues that will help someone find a tree.
  - Seasonal identification. How do different types of trees change seasonally?
- c. Dichotomous Key. Students apply a dichotomous key as one way of identifying different species.
  - Explain that one way to identify trees is to use a dichotomous key, which is a series of choices between two things.
    - If students aren't familiar with a dichotomous key, show an example. A quick internet search yields many examples.
  - Play a game of "Guess Who" using a volunteer. Students need to identify characteristics of the student using two category questions. Make sure to ensure a safe environment for the volunteer. For example, characteristics could include:
    - jeans: is wearing jeans or not wearing jeans
    - eye colour: green or blue/hazel or brown
    - hair length: above or below jaw line
  - Go back and fill in the opposite answers using another student, then a third.
  - Have students determine a secret person of their choice, pointing out that questions should start out more general, and then work towards more specific. Repeat with an object.
  - Ask students to explain what they think the rules are for a dichotomous key. How are they designed to help people identify what kind of item or living thing they are looking at? (For example, there are a series of questions with two choices; the questions start general and get more and more detailed as questions are answered. Every branch ends in an identification.)
  - Students can use Blackline Master 8-2, page 226, *Tree Classification* to create a simple dichotomous key. They can use four or five of the images, or all eight.

 Blackline Master 8-2,  
page 226,  
*Tree Classification*



## UNIT 8 • FORESTS AND FIRST PEOPLES

- Students can begin by identifying the trees from the foliage shown, using the key in *Tree Book* by Roberta Parish.
- Then they can construct a dichotomous key using observable features in the images, as described in *The Tree Book*.
- Have your students build their own dichotomous key for five different plants that can be found in your local area,
  - Have students complete a key with a guide for the identified plants explaining features and uses, like that found in *The Tree Book* using photographs or videos as well as text.
- Compile the keys into a class project. Have students use the class key to identify plants outdoors.



### Formative Assessment Strategy

Does the student key work, and is it easy for others to use?

## Activity 8.3

### Tree Stories

---

Students investigate a culturally significant tree to find out how its structure is interconnected with its ecosystem and the local First Peoples.

- Introduce students to the project which asks them to find out about a culturally important tree. Students could work in pairs, groups or individually to investigate one tree.
  - Decide on how students will select the tree to study. You may want to have everyone work together to study one of the most significant trees in the local area, or a number of trees that grow locally. Alternatively, students could choose trees from around the province.
- When students have selected their tree, have them brainstorm everything they know, or think they know, about the tree.
  - After they have finished the brainstorm, have them create questions that they will need to find out.
  - Students could use a K-W-L graphic organizer for this activity.
- Discuss as a class what kinds of information they need to find out about to tell the story of the tree and its interconnections. Write their suggestions on the board.
  - Allow the topics or categories to come from the students. Below are some of the main topics. If students don't come up with one or more, guide them to understand why that topic might be important.
    - Tree structure, parts of the tree
    - Biological processes, such as photosynthesis, reproduction, movement of sap
    - How long it take to grow to specific dimensions
    - Evolutionary adaptations, if any
    - Ecological role of the tree. How does it work with other plants and animals to benefit the environment?

## UNIT 8 • FORESTS AND FIRST PEOPLES

- Traditional uses by First Peoples
  - Names and words associate with the tree in the First Nations language.
  - Cultural connections to the tree, such as narratives about it, ceremonies, spiritual and ceremonial uses
  - Economic uses
- d. Students research their tree using books from the library and online resources. A good starting place is the *Tree Book*.
- e. As they are doing their research, ask students to think about what makes their tree significant. Suggest they consider different ways that it is significant, such as its significance to First Peoples, its economic significance today, its ecological significance.
- f. When they have gathered their data, students then compile their information into a narrative or story format. Ask, what would a science story look like? How would it be different from a science report?
- Discuss features of stories that they could use. For example:
    - stories have a beginning, middle and end
    - usually have a complicating factor
    - select important details - can't put everything in
    - use comparisons and metaphors to help explain
  - Discuss possible formats for the final product, and who the audience will be, such as younger students, Elders group, newspaper, science journal. The story could be told orally, in a story circle setting or recorded as a podcast; it could be told as an animation, or written in an illustrated book.
  - Ensure that students understand it is a science story, and is not intended to look like a traditional First Nations narrative.
- g. Students can work as a class to decide on the criteria for assessing their narratives. Have students share their stories with each other and their intended audience.



### Formative Assessment Strategy

Use self-assessment or peer-assessment following the criteria established by the class

## Activity 8.4

### Cedar: Tree of Life

---

One of the most significant trees for First Nations in parts of BC is the Western red cedar, and is often called the Tree of Life. This activity could be used as a model for students' inquiry into other trees, or as a stand-alone study of the cedar.

- a. Ask students if they know why the cedar is often called the Tree of Life. Have students volunteer suggestions based on what they may know about the cedar.
- b. Identifying a Cedar Tree
  - Have the class brainstorm the different parts of a cedar tree, and how they can tell them apart based on appearance.
  - Using the *Tree Book* or other resource, review the characteristics of a western red cedar and a yellow cedar. Ask students to name the key identifying features of these trees.
- c. The Parts of the Cedar Tree
  - Physical aspects and cultural uses. All parts of the cedar are used for a variety of purposes. Examples:
    - Roots: medicine and basket weaving. Can also be pounded and used for clothing and regalia. (only 2 roots per tree)
    - Outer Bark: Tools and roofing, when removing bark, there is a limit to the amount of bark taken. Never remove more than  $\frac{1}{4}$  of the tree bark, and only remove bark from the North side of the tree
    - Inner Bark: weaving, clothing and regalia, rope making, medicine, tea for spiritual cleansing rituals
    - Wood: Planks, shelter, bentwood boxes, poles, canoes, masks, decoration, (modern lumber sales)
    - Branch: Weirs, smoking food, weaponry, bathing, brushing, spiritual cleansing, medicine, lashings and bindings
    - Leaves/Tips: edible (when new growth), smudging, medicine, bedding, dyeing, cleaning, rituals
  - Students can learn about how First Peoples traditionally use different part of the cedar. Possible resources include:
    - Journey into Time Immemorial website. SFU Museum of Archaeology and Ethnology 2009-2009. Linked at <https://tinyurl.com/fnesc34>.
    - Hilary Stewart, *Cedar*. Douglas & McIntyre, 1984.
    - Nancy J. Turner. *Plant Technology of First Peoples in British Columbia* Royal BC Museum, 2007.
  - Have students work in groups to prepare a presentation to the class, using an interesting format, explaining the scientific role as well as the local cultural aspects and protocols of the part of the cedar.

## UNIT 8 • FORESTS AND FIRST PEOPLES

- If your local First Nations community owns and operates a cedar mill, explore the potential of a guest speaker or field trip to discuss the economic role of cedar.
- d. Ecological Role of Cedar
- Remind students of the importance of individual species working together in an environment to create an ecosystem. For this lesson you will be highlighting some of the unique roles that the cedar plays in a forest ecosystem.
  - If possible, take students to a cedar stand and point out the following aspects:
    - Cedar oil. Adult red cedar trees produce an oil that is toxic to fungi and bacteria. Due to this, red cedar trees do not rot and decompose in the same way, and at a much slower rate than other vegetation. This allows for a deep humus layer, which is needed for many shrub layer plants.
    - Canopy. Red Cedar have wide ranging branches that cover the top two thirds of the tree. This gives ample shade and habitat to many plants and animals within the tree itself, or at its base. Within the canopy, this offers several unique habitats for species like epiphytes not found elsewhere. (See <http://wetbelt.unbc.ca/canopy-synopsis.htm>)
    - Water retention. Increased detritus and humus hold the water that is drawn towards the tree through the roots but not adsorbed. This cools the area and allows for symbiotic and parasitic growth of lichens and mosses. The extra water is used by other plants in the area with shallower root systems.
    - Carbon cycle. The cedar tree, as a gymnosperm, photosynthesizes year-round. In doing so it converts atmospheric carbon (CO<sub>2</sub>) into organic carbon compounds. This is the primary method of reducing greenhouse gases in our province. (See Activity 8.7, Carbon Sequestration in Trees.)
- e. Have students choose one of the above (or an approved aspect) of the role of western red cedar in the environment and ecosystem. Have your students complete research to better understand their aspect.
- Once finished, pair students up with different aspects and have them find links between their findings.
  - Create a large-scale web that identifies how all aspects are interrelated and support each other.
  - Have a knowledge-keeper come in to talk about the importance of the cedar tree in determining the health of the forest.
- f. Cedar and Culture
- Students can view one or more videos that tell about the importance of cedar to First Nations cultures.
    - Bark Peeling. Hartley Bay School 2015. 2:44 min. <https://youtu.be/YxuS6Qk8nzk>

## UNIT 8 • FORESTS AND FIRST PEOPLES

- *Bill Reid*. NFB 1979. 27:56 min. [https://www.nfb.ca/film/bill\\_reid/](https://www.nfb.ca/film/bill_reid/)
  - *The Story of Cedar* (Sechelt Art Fest 2015) Blue Zula, 2015. <https://youtu.be/WIcT9Jx0T7g>
  - Hold a discussion with the class about what they learned and have connections or experiences related to the film.
- c. Contact your school district Aboriginal / Indigenous Department or community knowledge-keepers to discuss local practices involving cedar. Where possible and appropriate, have your students participate in an activity such as:
- a cedar bark harvesting and/or
  - harvesting/cutting down a tree
  - a weaving activity
  - making a bentwood box
  - making a traditional box or hand drum
- Include a discussion on the protocols and traditional practices used in your area.
  - Invite a local Indigenous artist to show their work to the class and speak on the importance of preserving culture through art.
  - Arrange a field trip that will include the viewing of traditional items in which cedar is used.

### Activity 8.5 Cedar Oil As An Antibiotic

Cedar oil, branches and tea have been used traditionally amongst many First Peoples in British Columbia. It is used medicinally to restore health and ward off illnesses. This is a lab activity that can be completed as a stand-alone activity or as an extension to a bacterial sample and growth lab.

#### Materials

- Agar plates
- Loops with bacterial samples OR collect your own samples
- Cedar oil (essential oil obtained by steam extraction)
- Petri Dish Mapping, Blackline Master 8-3, page 228

- a. Have students plate their agar (or provide pre-poured petri dishes). Dishes should be sectioned into sixths, with an A and a B half-allowing for three sections each.
- b. Students should use a loop to place a small amount of Cedar Oil in the centre of the section, and radiate it outwards to thin the sample before inoculation. Plates should sit (covered and cool) until adsorption occurs.



**CAUTION**  
Over-exposure or use of cedar oil can be toxic. Be sure to wash hands and area well with soap and water after use and avoid contact with eyes/mouth.



Lab Activity

 Blackline Master 8-3,  
page 228, *Petri Dish  
Mapping*

 **Formative Assessment  
Strategies**  
Were students able to  
communicate their findings  
in a way that is supported by  
their experiment?

- c. Students inoculate their petri dishes with bacterial samples via either loops and broth, OR samples they obtain around the school with cotton swabs.
- d. Students should inoculate 2 dishes, in symmetry, placing the same sample in opposite sections. Samples should be smeared close to, but not touching all edges of the section. Students should label the sections on the dish.
  - Students can use Blackline Master 8-3, page 228, *Petri Dish Mapping*, to record their observations.
- e. Students then incubate the samples for 1-3 days to see growth. Have students observe and document bacterial growth and inhibition.
- f. Ask students, What inferences and conclusions can be drawn by what occurred?

## Activity 8.6

### Making Pine Pitch Or Spruce Glue

---

Spruce resin or gum was often used traditionally as an agent for adherence. In this lesson students explore the activity of making spruce pitch glue and go further through either testing the strength of glues or create a (hypothetical) class that you might deliver to younger grades that will test the strength of glues.

 **Lab Activity**  
Making Pitch Glue

Materials required are: pitch or resin; charcoal; a container

- a. To introduce the procedure, students can view the video *Spruce Pitch Glue*. It is not an Indigenous video, but demonstrates the process of gathering and pitch and making the glue in the field.  
Online at <https://youtu.be/l3Fyl7NFnO0>.
- b. Collect resin from a spruce tree. Ensure that you and students follow appropriate protocols and permission. Discuss how you can pay respect to the tree when taking the pitch.
- c. In the lab or an appropriate outdoor location, have students follow these steps:
  - Melt the resin
  - Add an equal amount of charcoal powder (bonding agent that helps temper the resin and reduce the stickiness).
  - You can add a filler too if (i.e. dried leaves, deer droppings, crushed up)
- d. Students can vary the ratio of charcoal with pitch and test which makes a better glue.
- e. Students can work in groups to create a lesson that they could deliver to younger grades that will test the strength of glues.

## Activity 8.7

### Carbon Sequestration in Trees

Have students estimate the biomass and nutrient content of trees around your school and calculate the approximate carbon content. (This calculation is adapted from the activity Carbon in the Classroom, found online at <http://bit.ly/2dKrwB5>)

- Select the area for your field study. There should be enough trees for small groups of students to each have a study tree.
- In the field, have students record data about their tree.
  - Record information about their tree, such as location, species.
  - Measure the diameter of the tree at about 1.3 m from the ground.
- In the class, have students calculate the approximate biomass using the calculator at the Natural Resources Canada website, <http://bit.ly/2dKs4H6>
  - The biomass calculator gives separate biomass readings for bark, branches, foliage and wood. Students should give the total of these figures.
  - You may want to use Blackline Master 8-4, page 229, *Biomass Calculator* to help students use the online app.
  - Add to this figure the approximate biomass for the roots by multiplying by 1.26.
- From the rough biomass calculation, students can determine the carbon that might be stored in the tree.
  - Multiply the approximate biomass by 0.5.
  - Multiply the result by 3.7\* to give the approximate amount of carbon dioxide stored in the tree in kilograms.
- What do the numbers mean?
 

Ask students to find some examples of CO<sub>2</sub> emissions and compare with the amount of CO<sub>2</sub> their trees are sequestering.

  - For example, a jet flight from Vancouver to Prince George, about 500 km distance, produces about 152 kg of CO<sub>2</sub>.
- Trillion Tree Campaign. Students may be interested to learn about a recent movement that calls for the planting of a trillion trees around the world by 2050. Students can research current news articles to find out why so many trees should be planted, and what the expected results of such a venture would be.
  - See the website of the organizing groups: <https://www.trilliontrees.org>

 Blackline Master 8-4,  
page 229,  
*Biomass Calculator*

#### Example calculation of carbon sequestration

Western red cedar  
diameter at 1.3 m: 20 cm  
Biomass calculation (from NRC calculator)

- bark 5.42 kg
- branches 20 kg
- foliage 11.54 kg
- wood 49.17 kg
- Total: 86.13 kg

tree + roots biomass  $86.13 \times 1.26 = 108.52$  kg

Approximate carbon stored in tree  
 $108.52 \times 0.5 = 54.26$  kg  
Approximate CO<sub>2</sub> sequestered in the tree:  
 $54.26 \text{ kg} \times 3.7 = 200.77$  kg

\* This number is referenced in Carbon in the Classroom, online at <http://bit.ly/2dKrwB5>.

- Students can find many news sites that report on the campaign. One example is on the CBC web, “Best way to fight climate change? Plant a trillion trees. 2019, linked at <https://tinyurl.com/fnesc33>.
- Ask students to explain how this campaign relates to carbon sequestration in trees.

## Activity 8.8

### Tracking Historical Forest Fires.

---

Students can use a web-based mapping tool to view and interpret historical forest fire data.

- The provincial government has amassed a wide variety of data in the web-based application iMapBC. One of the data sets is the location, extent and date of forest fires in the province from the 1920s to the present.
  - The iMapBC site is linked at <https://tinyurl.com/fnesc28>.
- Have students can use Blackline Master 8-5, page 230, *Mapping Historical Forest Fires in British Columbia* to access the forest fire data on iMap.
  - For this activity students need access to a computer or tablet. They will use the iMapBC application. Ideally they will be able to print the resulting map.
- Have students select a region of the province to study historical forest fires. It could be your local area, an area where forest fires have been reported in the news, or a part of the province students have an interest in.
- Students can work individually or in pairs to analyse the date shown on the region they have selected.
  - Tally the number of forest fires in the region over time and graph them on a timeline. Students can find a way to show the size of each fire graphically.
  - Analyse the distribution of forest fires in the region over time. For example, were there more fires in the past or more in recent years?
  - Is there any pattern to the sizes of the fires? Were they bigger or smaller in the past, or are they random?
- Have students find a First Nation community within the region under study. Ask questions such as:
  - From the data on the map, can you infer anything about how forest fires may have affected the traditional territories of the First Nation?
  - What other information might you need to be able to understand how the fires affected First Nations?
- Ask students what conclusions, if any, they can draw about forest fires in their region using the data on the map.
- Ask students how the data on this map might be used. Who might use it?

 Blackline Master 8-5, page 230, *Mapping Historical Forest Fires in British Columbia*



## Culturally Significant Trees of BC

Which of these trees do you know? Which grow near where you live?  
Find out one or two reasons they are culturally significant for First Peoples of BC.

BALSAM POPLAR	BLACK COTTONWOOD	BLACK SPRUCE
DOUGLAS FIR	ENGELMANN SPRUCE	LOGEPOLE PINE
PONDEROSA PINE	SITKA SPRUCE	WESTERN HEMLOCK
WESTERN RED CEDAR	YELLOW CEDAR	YEW

# Tree Classification

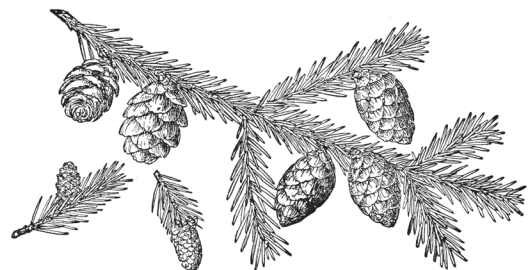
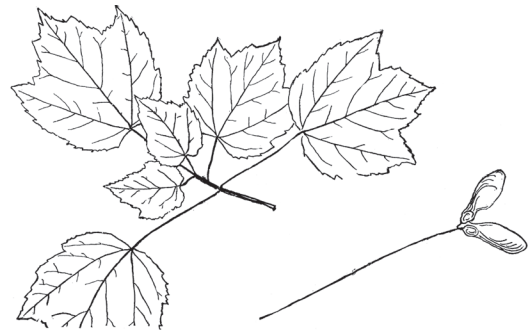
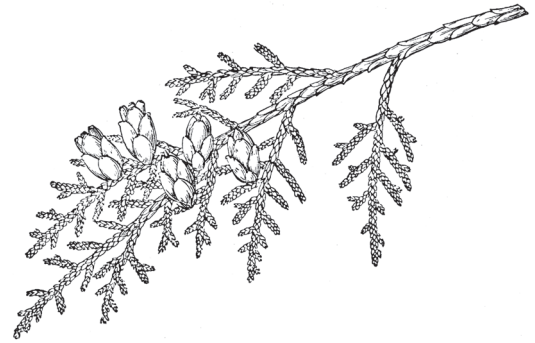
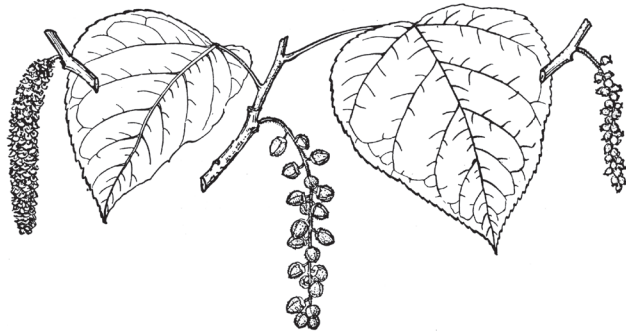

# Tree Classification Key

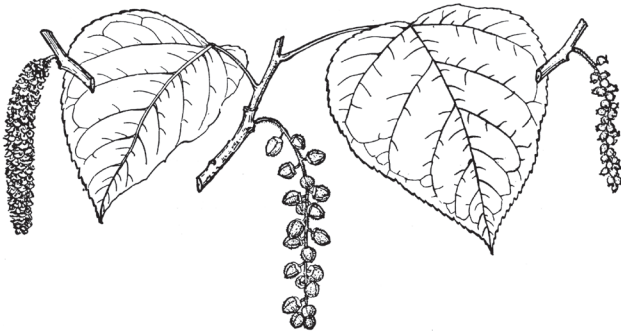

**Black cotton**

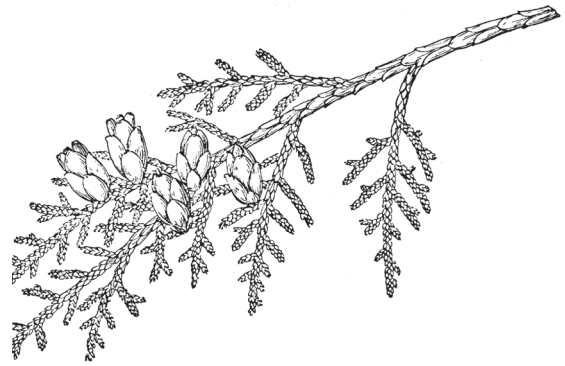

**Western red cedar**



**Ponderosa pine**

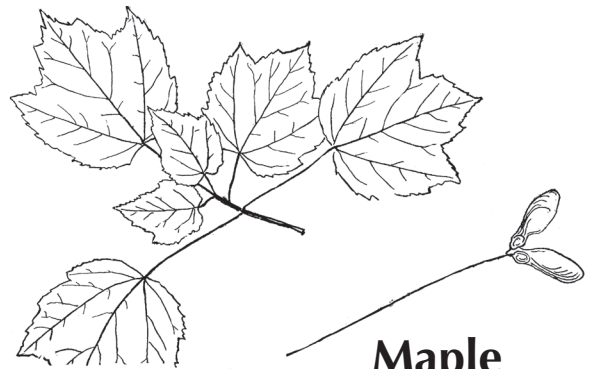

**Maple**



**Hemlock**



**Dogwood**



**Birch**

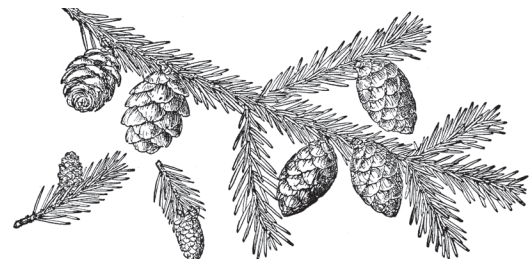

**Black spruce**

Blackline Master 8-3  
**Petri Dish Mapping**

Petri Dish \_\_\_\_\_

LEGEND

A1  
A2  
A3  
B1  
B2  
B3

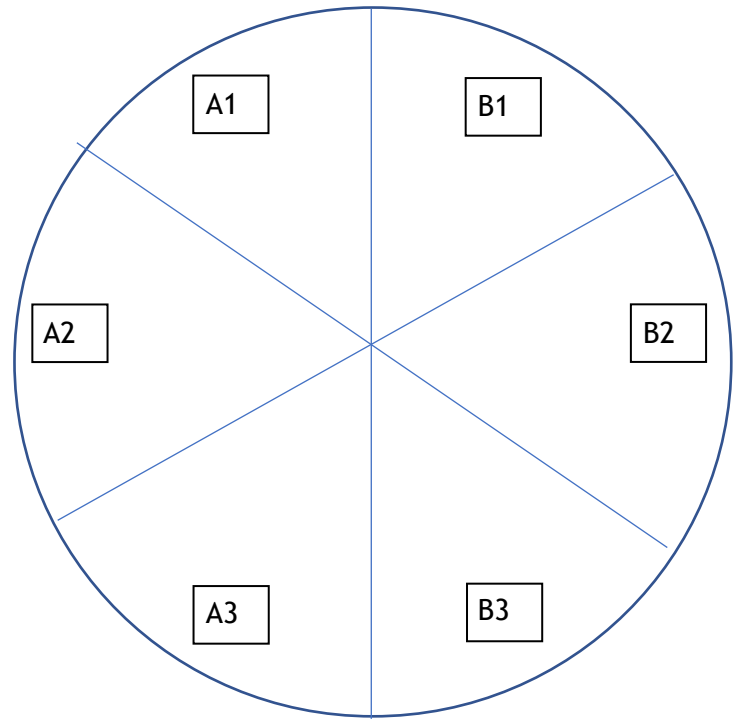

Petri Dish \_\_\_\_\_

LEGEND

A1  
A2  
A3  
B1  
B2  
B3

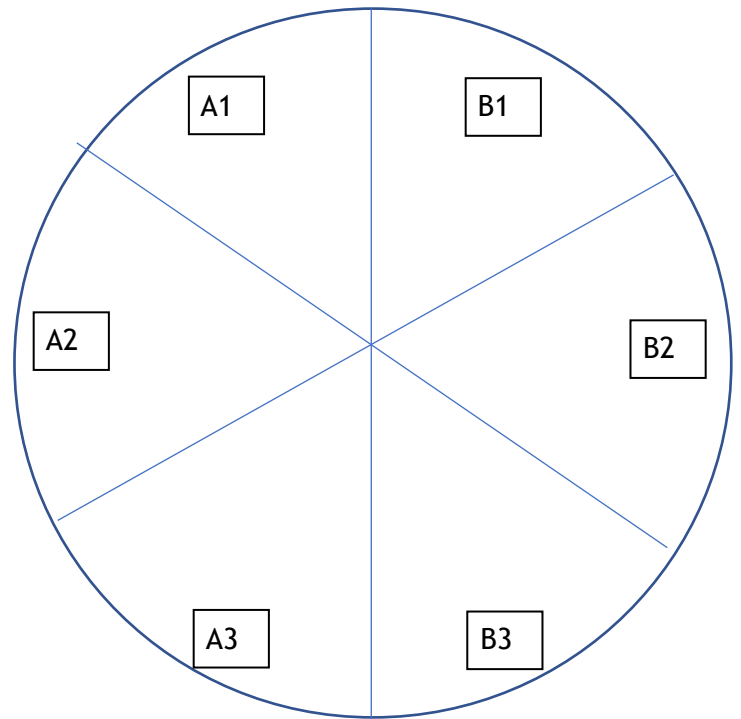

## Using a Biomass and Nutrient Calculator

Scientists and forest managers often need to calculate the biomass of a stand of trees in a forest. The results can be used to determine the potential of the forest to be used to make forest products. They are also used to make carbon and nutrient budgets to evaluate environmental sustainability.

This biomass calculator was developed by Natural Resources Canada, part of the Canadian government. It gives a statistical estimate based on thousands of sample trees entered into a database.

Follow these steps to use the calculator.

1. Find the web page that has the calculator. Search for the key words “Canada biomass calculator or go to the link <http://bit.ly/2dKs4H6>
2. Scroll down until you see the Tree-level biomass calculator
3. In the first field select a species, such as black spruce.
4. In the second and third fields enter a diameter and height. For black spruce, enter a diameter of 25 cm and height of 20 m.
5. Click or tap on the Calculate button. This takes you to a results page. You will see the biomass reported for each part of the tree: bark, branches, foliage and wood in a graphic form.

Below that is a graph which repeats the biomass information and also displays an estimate of the nutrient content for each part. This includes the content of nitrogen, phosphorus, potassium, calcium and magnesium.

(Note that not every species has complete data for the nutrition information.)

## Mapping Historical Forest Fires in British Columbia

Follow these directions to use iMapBC to track historical wildfires in BC.

1. Go to iMapBC home page. (<https://tinyurl.com/fnesc28>).
2. Under the "applications" heading, select "Launch iMapBC."  
You can scroll on the map or zoom in or out using the "+ -" (below the "I want to..." on the top left hand corner of the map).
3. Click on the "I want to" blue box and then click on "Add Provincial Layers"
  - An "Add/Remove Map information" box will appear.
  - Find Forest Grasslands and Wetlands and click on the "+" sign in front of it.
  - Click on the "+" sign beside BC Wildfire Service.
  - Click on the box beside BC Wildfire perimeters - Historical - Colour Hatched.
  - Select "OK" at the bottom of the window.
  - If nothing changes on the page, you will have to zoom in until you see hatched marks on the map (0:20km).
4. Now go to "Data Sources" tab (next to the home tab).
  - Click on "My Layers"
  - Below that, click on arrow next to "BC Wildfire Fire Perimeters"
  - Scroll down and Click on "Customize labels"
  - Click on "Customize"
  - Under the Field tab, Click on ""fire year"
  - Finally, click on "Apply."
5. You will see you have created a map that displays the historical fires that have occurred around the province.
6. Add one more layer....to do this:
  - Click on "Data Sources"
  - Click on "Add Provincial Layers"
  - Click on "Archeology and Culture"
  - Click on First Nations Community Locations
  - Click on (or check mark the box) next to First Nations Community
  - Click on "OK."
7. Find an area of the province to study. You can print the map or study it on the screen.
8. To print your map go to "export." Choose "print. Provide a title, your name and date.
  - There is a box at the bottom of the "print map" box that asks "Lock print preview with map." Make sure you do NOT have a check mark in the box.
  - Select "Print Map"



# Unit 9

## Hunting and Trapping

### Overview

For First Peoples, hunting and trapping have always been important for maintaining life. In the past, the animals of the land, sea and air provided food, clothing and material resources for many technologies. Today many First Peoples are less reliant on hunting and trapping, but these activities are still culturally important in diverse ways.

In this unit students can investigate the Indigenous science and traditional knowledge inherent in hunting and trapping practices from a number of perspectives, including:

- cultural and spiritual connections to animals.
- traditional ecological knowledge about the life, behaviour and habitats of the animals
- reciprocal and sustainable aspects of hunting
- science knowledge that underlies the use of various technologies during the hunting and trapping processes (relates to physics, biology and environmental sciences)
- science knowledge that underlies the processing of skins and furs, including tanning (relates to chemistry, biology, environmental sciences.)

How you approaches this unit may depend a great deal on the location of your school. In some parts of the province, students will have considerable personal experience with hunting and trapping. In other areas, such as in urban centres, students may find the topic unfamiliar or even disturbing.

### Guiding Questions

- In what ways can trapping and hunting impact an ecosystem?
- How was/is Indigenous knowledge used to hunt and trap sustainably?
- What Indigenous scientific knowledge is used in traditional methods of processing and preserving animals both as food and as resource materials including furs and hides?

## UNIT 9 • HUNTING AND TRAPPING

### Relevant BC Learning Standards for Senior Secondary Science

Course	Key Content Standards	Key Curricular Competencies
Science 10	<ul style="list-style-type: none"> <li>Practical applications and implications of chemical processes, including First Peoples knowledge</li> <li>transformation of energy</li> </ul>	<p><b>Questioning and predicting</b></p> <ul style="list-style-type: none"> <li>Make observation aimed at identifying their own questions, including increasingly abstract ones, about the natural world.</li> </ul> <p><b>Planning and conducting</b></p> <ul style="list-style-type: none"> <li>Collaboratively and individually plan, select and use appropriate investigation methods, including field work and lab experiments, to collect reliable data.</li> </ul> <p><b>Processing and analyzing data and information</b></p> <ul style="list-style-type: none"> <li>Experience and interpret the local environment</li> <li>Apply First Peoples perspectives and knowledge, other ways of knowing and local knowledge as sources of information</li> </ul> <p><b>Evaluating</b></p> <ul style="list-style-type: none"> <li>Consider social, ethical, and environmental implications of the findings from their own and others' investigations</li> </ul> <p><b>Applying and innovating</b></p> <ul style="list-style-type: none"> <li>Contribute to finding solutions to problems at a local and/or global level through inquiry</li> </ul> <p><b>Communicating</b></p> <ul style="list-style-type: none"> <li>Express and reflect on a variety of experiences, perspectives, and worldviews thorough place.</li> </ul>
Chemistry 11	<ul style="list-style-type: none"> <li>applications of organic chemistry</li> </ul>	
Environmental Science 11	<ul style="list-style-type: none"> <li>First Peoples knowledge of climate change and interconnectedness as related to environmental systems</li> <li>Resource stewardship</li> </ul>	
Life Sciences 11	<ul style="list-style-type: none"> <li>First Peoples understandings of interrelationships between organisms</li> </ul>	
Physics 11	<ul style="list-style-type: none"> <li>Application of simple machines by First Peoples</li> </ul>	
Physics 12	<ul style="list-style-type: none"> <li>First Peoples knowledge and applications of forces in traditional technologies</li> </ul>	



## Cross-Curricular Connections

Social Studies courses

- This unit can be correlated with Unit 6 in the FNESC Teacher Resource Guide, *BC First Nations Land, Title, and Governance*. In Unit 6, Hunting and Trapping Case Studies, students use primary source documents to examine how government laws and policies impacted traditional hunting and trapping in the early 20th century.

Culinary Arts 10, Food Studies 10

- Content Standard: First Peoples food protocols, including land stewardship, harvesting/gathering, food preparation and/or preservation, ways of celebrating, and cultural ownership
- Curricular Competencies: Evaluate the influences of land, natural resources, and culture on the development and use of tools and technologies

## Resources

For further information on these resources, see the annotations in the Bibliography, beginning on page 273.

### *Suggested Resources*

- Samples of items made by First Peoples out of tanned hides

Print

- Moran, Bridget and Mary John. *Stoney Creek Woman*. Arsenal Pulp Press, 1988.

Web based

- The Ancient and Arduous Art of Brain Tanning Buffalo Hides. Gene Gade. Online article at <https://bit.ly/2SgEYfA>.
- Big Game Information. BC Ministry of Forests, Lands and Natural Resource Operations. Online at <https://bit.ly/2DVnmRp>
- “Experiments In Hide Brain-Tanning With A Comparative Analysis of Stone and Bone Tools.” Matthew Richter and Darby Dettloff. <https://bit.ly/2DX9VAj>.
- *Hunting & Trapping Regulations Synopsis*, published by the BC Fish and Wildlife Branch at <https://bit.ly/2MHPPxZ>
- *The Learning Circle*. Classroom Activities. Indigenous Affairs, Canada, 2012. <https://bit.ly/1MTii1J>

## UNIT 9 • HUNTING AND TRAPPING

- Management Guidelines for Furbearers. BC Ministry of Forests, Lands and Natural Resource Operations. Online at <https://bit.ly/2GRLjfx>.
- Traditional Animal Foods of Indigenous Peoples of Northern North America. Harriet V. Kuhnlein and Murray M. Humphries. McGill University. Online at <http://traditionalanimalfoods.org/>

### Video

- Deadfall Trap, SKCradleboard Initiative, 2015. [https://youtu.be/9\\_vKkCoqi5g](https://youtu.be/9_vKkCoqi5g).
- Hide Tanning the Woods Cree Way. Video, 17 minutes. Portage College, 2014. Online at <https://youtu.be/SWUCC00yGd8>.
- Skeena River Trapline. National Film Board, 1949, 16 min. <https://tinyurl.com/fnesc35>

### Additional Resources

- Furniss, Elizabeth. *Dakelh Keyob: The Southern Carrier in Earlier Times*. Quesnel School District and Kluskus, Nazko, Red Bluff and Ulkatcho Indian Bands, 1993.
- Keith Lemaigre. Trapping. La Loch Community School, Saskatchewan. Lesson plans and activities dealing with trapping. <https://tinyurl.com/fnesc36>.
- “Life on the Line. Are fur trappers stuck in the past or a vital piece of Canada’s living heritage?” CBC website and videos. <http://www.cbc.ca/news2/interactives/fur-trapping/>
- McIlwraith, Thomas. *‘We Are Still Didene’: Stories of Hunting and History From Northern British Columbia*. University of Toronto Press, 2012.

### Blackline Masters

- 9-1 Mammals of BC
- 9-2 Mammals of BC - Classified
- 9-3 Traditional Hunting and Trapping Technologies
- 9-4 Dead-Fall Trap Examples
- 9-5 Steps in Brain Tanning

### Outline of Activities

- 9.1 Hunting and Trapping: A Way of Life
- 9.2 Knowing Animal Habitats and Behaviour
- 9.3 Traditional Hunting and Trapping Technologies
- 9.4 The Physics of Trapping
- 9.5 The Chemistry of Tanning

## Suggested Activities

Note: There are more activities here than most teachers will incorporate into their units. It is not expected that you will use all of the activities, or follow the sequence as they are described. These activities are intended to be adapted to fit the needs of your students and classroom, as well as inspire ways that you can include relevant Indigenous content in your lessons.

It is important for students to approach these activities with a respectful frame of mind. This reflects an Indigenous perspective of hunting, which views the animals as relations who give themselves up to aid people. In the past, hunters followed special protocols, rituals and ceremonies before going on the hunt, and many still do today. During and after the hunt there were also protocols to be followed. These ensured humans kept in balance with other species.

### Activity 9.1

#### Hunting and Trapping: A Way of Life

---

Introduce the cultural importance of the hunting and trapping lifestyle in the past, and for some First Peoples, today.

- a. Introduce the topic by discuss what students know or understand about the practice of hunting and trapping.
  - Ask questions such as:
    - Do you have experiences with hunting or trapping?
    - Why did First Peoples hunt and trap in the past?
    - Do people still hunt and trap today?
    - Who governs hunting and trapping?
  - Explain that for most First Nations communities in the past, hunting and trapping were vital for health, nutrition, culture and society. Today hunting and trapping are still important for many First Peoples, who continue to rely on animal food sources for food security.
  - Ask students to think about the types of Indigenous Scientific Knowledge that First Peoples used in the past to ensure that they used the animal resources as a sustainable source of food and materials. You could discuss as a class, or students could brainstorm ideas and share them.
    - Explain that they will be exploring some of the ways that First Peoples used scientific knowledge in traditional hunting and trapping activities.

## UNIT 9 • HUNTING AND TRAPPING

 *Skeena River Trapline*,  
National Film Board,  
1949. 16 min.  
<https://tinyurl.com/fnesc35>



- b. *Skeena River Trapline*. Students can view this 16 minute National Film Board movie, made in 1949, when trapping was more of a way of life than it is today. Let students know that, consistent with the time it was made, the term Indian is used throughout to refer to Indigenous people, and that the narrator mispronounces the name Gitxsan. Note: The film shows the shooting, skinning and processing of a deer.
- Ask students to watch and listen for examples of scientific knowledge that the trapper used.
  - Discuss what technologies were used. Ask, how do you think these were different in pre-contact hunting and trapping?
- b. *Stoney Creek Woman*. Students can read or listen to a description of the hunting and trapping life for a First Nations family in the early twentieth century from the book *Stoney Creek Woman*. (Bridget Moran and Mary John. Arsenal Pulp Press, 1988.)
- The book is the story of Mary John, a Dakelh woman who was a strong leader in her community and provincially.
  - Pages 38 to 42 describe her memories of going to hunting and trapping camps on her family's traditional territories as a child. The passage explains how the whole family was involved in the hunting and trapping activities, and conveys the strong emotional attachment to those experiences.
  - Students can listen or read to identify the roles of each member of the family in the different activities, such as setting up and maintaining camp, harvesting and preparing the game hunted for food and the furbearers trapped for income.
  - Discuss how the passage conveys a sense of place associated with hunting and trapping on the land. For example, there was so much to see on the land that was full of life; observing the animals and birds; living off the land in camp; feelings connected with arriving and leaving camp – anticipation for arrival and sadness at leaving; accustomed to the hard life on the trapline; “the places in which we lived – all, all were important to the survival of our family. (p 42)”
- c. A Hunter's Story. Students can read a short account of hunting by a First Nations Elder. It discusses how he learned to hunt, and how hunting and trapping have changed. It is found on page 19 of *The Learning Circle: Classroom Activities*. Indigenous Affairs, Canada. 2012, online at <https://bit.ly/1MTii1J>
- d. Local Hunting and Trapping Connections. Investigate how significant hunting and trapping activities are in your local area.
- Discuss with students if they are aware of hunting or trapping activities in your region. Some may have families that engage in hunting.
  - Students can refer to the BC Hunting and Trapping Regulations Synopsis to find out what areas are permitted hunting areas in your region, and what animals are allowed to be hunted or trapped there.

## UNIT 9 • HUNTING AND TRAPPING

- Download the current *Hunting & Trapping Regulations Synopsis* published by the Fish and Wildlife Branch at <https://bit.ly/2MHPPxZ> or you can get printed versions at various locations such as the local ServiceBC office.
  - Ask students to find out from the regulations if they would be able to get a hunting license and if so, what they would have to do to get it. Have them find out how much it would cost for the license. (Everyone aged 10 and over can get a hunting license. There are Youth Hunting Licensees.)
- d. Local First Nations. Where possible, students can learn about traditional and current hunting and trapping practices of local First Nations.
- Invite an Elder or knowledge-keeper to talk about their traplines in the area, if they have any.
  - Language: Find words and phrases in the local First Nations language that relate to hunting and trapping.

### Activity 9.2

#### Knowing Animal Habitats and Behaviour

---

Students consider how did/do Indigenous hunters understand and make use of behaviours of animals and their habitats when they hunt and trap.

- a. What animals provided significant resources for First Peoples in the past?  
Have students work in groups to brainstorm animals that First Peoples in BC hunted or trapped in the past.
- Students can identify how they think then animals were used by First Peoples in the past. (food, furs for clothing, hides for many purposes, bones for tools)
- b. Students can work with Blackline Master 9-1, page 243, *Mammals of BC* to find other animals that aren't on their list.
- Students could use the Blackline Master for a classification activity, either by cutting the words into cards or by listing categories in their notebooks. Ask students to classify them from different perspectives, such as from:
    - an Indigenous perspective
    - a wildlife biologist's perspective
    - a tourism perspective
    - an environmentalist perspective
  - Blackline Master 9-2, page 244, *Mammals of BC Classified*, suggests one way of sorting the animals. Ask, whose perspective does this classification does this show? (e.g. a hunter and trapper's perspective)
- c. Ask, "What would a hunter or trapper need to know about the animals they harvest? Discuss some reasons why a hunter or trapper would need to

 Blackline Master 9-2,  
page 244, *Mammals  
of BC Classified*

## UNIT 9 • HUNTING AND TRAPPING

understand things like the life cycle, the anatomy, the food sources or the behaviours of an animal.

- Ask students to predict how animals' habits and habitats might influence the methods of hunting and trapping.
  - Some understandings that hunters and trappers require include:
    - How the animal behaves in each season
    - Reproductive cycles
    - Feeding patterns
    - Population numbers, when to harvest, when to leave so the population can recover
    - How to identify an animal's home (e.g. bear cave, muskrat pushup, beaver den, marmot hole)
    - How the animal senses work. Some have good eyesight or a keen sense of smell; most animals have acute hearing.
- d. Students choose one of the mammals to research in depth to find out how they were utilized by First Peoples in the past, and what traditional scientific knowledge was required to harvest them successfully and sustainably.
- Note that the suggested activity focusses on mammals, but you may want to give students the option of researching a bird species that has traditionally been hunted by the local First Nations community.
  - Discuss what types of information they could find out about their animal, such as:
    - anatomy
    - preferred habitat
    - distribution/ range in BC
    - food sources
    - life cycle
    - best time to harvest
    - behaviours e.g. do they like to stay in groups, or are they loners?
    - predators
  - After they have conducted their research, students can decide on how they will present their findings. For example, they could do it orally, visually or in written form.

Suggested online resources for researching animals:

- *Big Game Information*. BC Ministry of Forests, Lands and Natural Resource Operations. Online at <https://bit.ly/2DVnmRp>
  - This page has links to documents about the major big game animals in BC. They describe the ecology of the animal, including its ecological relationships, and its distribution and life history.
  - The animals listed are: bighorn sheep, black bear, caribou, cougar, elk, grizzly bear, moose, mountain goat, mule and black-tailed deer, North American bison, thimhorn sheep and white-tailed deer.

## UNIT 9 • HUNTING AND TRAPPING

- The documents include some information about traditional uses by First Peoples.
- *Management Guidelines for Furbearers*. BC Ministry of Forests, Lands and Natural Resource Operations. Online at <https://bit.ly/2GRLjfx>
  - This page has links to documents about some of the key furbearing animals in BC. They describe the physical, biological, behavioural characteristics and guidelines to manage the species.
  - The animals listed are: beaver, bobcat, coyote, fisher, fox, lynx, marten, mink, muskrat, otter, weasel, wolf, wolverine.
  - The documents do not include information about First Peoples traditional uses of the animals.
- *Traditional Animal Foods of Indigenous Peoples of Northern North America*. Harriet V. Kuhnlein and Murray M. Humphries. McGill University. Online at <http://traditionalanimalfoods.org/>
  - This is a comprehensive database compiled from an academic survey of published literature about Indigenous uses of animals.
  - To access information about specific animals students should first select the Animals tab on the home page, then follow further links to get to their animal of study.
  - The ethnographic database covers all of northern North America and is not broken down by province. Students will need to be familiar with BC First Nations to identify specific content relation to BC.

### Activity 9.3

## Traditional Hunting and Trapping Technologies

---

Students investigate what technologies First Peoples use to hunt animals in the past, prior to the introduction of guns and steel traps.

- Ask students to suggest ways that First Peoples harvested animals in the past, before the introduction of guns and steel traps.
- Students can use Blackline Master 9-3, page 245, *Traditional Hunting and Trapping Technologies* to guide an investigation of the main methods traditionally used by BC First Nations. It can be used in a number of ways:
  - Identify each of the methods and the technologies involved.
  - Identify which technologies were used in your region.
  - Match the method with the animals that it was usually used for
- Students work individually or in groups to research one of the technologies in depth. Discuss what types of information they could learn about. For example:

 Blackline Master  
9-3, page 245,  
*Traditional Hunting and  
Trapping Technologies*

## UNIT 9 • HUNTING AND TRAPPING

- why it was used
  - how it was used
  - what materials were needed to make or use it
  - what Indigenous scientific knowledge was used in its construction and operations
  - what scientific principles are involved in the technology. e.g. How is energy used or transferred during its operation?
- d. Students can represent their findings visually and share their projects with the rest of the class or others. Suggestions include:
- Design and build models of the technology
  - Illustrate the steps involved in making or using the technology

### Activity 9.4

## The Physics of Trapping

---

Students investigate what scientific principles First Peoples used in a traditional trapping technology.

- a. Explain that students will construct a working model of a deadfall trap and test the physics applied during its use.
- b. There are many ways to build a deadfall trap. Students can investigate different styles.
- Two styles are shown on Blackline Master 9-4, page 246, *Deadfall Trap Examples*.
  - The “figure 4” deadfall trap is demonstrated by a First Nations knowledge-keeper in the video *Deadfall Trap*, SKCradleboard Initiative, 2015. [https://youtu.be/9\\_vKkCoqi5g](https://youtu.be/9_vKkCoqi5g)
  - Other styles of deadfall traps may be found in books or online.
- c. Designing the trap.
- Students choose one style to construct.
  - Have students make a diagram of their version of the deadfall trap.
    - They can add arrows to indicate movement and how energy will travel when the trap is triggered.
- d. Students construct a working model of the trap.
- They can use materials found in the class, at home, or outdoors.
  - Students may want to help each other to be able to get their model to work.
  - Important: No animals are to be used in the experiment!
- e. Have students analyse their deadfall trap as a simple machine. What simple machines are used in its construction?

 Blackline Master 9-4,  
page 246,  
*Deadfall Trap Examples*

 Hands-On Activity



## UNIT 9 • HUNTING AND TRAPPING

- f. Students can design an experiment to collect qualitative and quantitative data using their model.
- Discuss how students could use the model to demonstrate the scientific ideas of pressure, kinetic and potential energy, forms of energy, and conservation of energy.
  - Students carry out their experiment and draw conclusions.
- g. Discuss the knowledge First Peoples used to design a deadfall trap that would humanely trap an animal. (For example, make it the right size for the target animal; ensure it is heavy enough to kill the animal instantly.)
- h. Ask students to reflect on the activities with questions such as:
- How did you feel building a model of a deadfall trap?
  - Did you find building the trap model easy or difficult? Why?
  - Why might a trapper use a deadfall trap today?



### Activity 9.5

## The Chemistry of Tanning

---

Students explore how First Peoples use knowledge of chemistry to produce tanned skins and hides.

- a. Show students samples of items made by First Peoples out of tanned hides, such as moccasins. Students may have some items they can bring from home to share.
- Students can observe the items and records sensory and other details they notice.
- b. Have students work individually or in groups to find out the steps involved in traditional brain tanning techniques.
- Ideally students would be involved in the processes, but this will be possible in only a few situations. However, some schools may have access to an Elder or knowledge-keeper who can explain the process.
  - Students can use a variety of resources and create their own list of steps involved.
    - Students can develop their own ways of presenting the steps in a graphic organizer. However they should include basic information about each step, such as materials, techniques and intended results of the steps.
    - Alternatively, they can use Blackline Master 9-5, page 248, *Steps in Brain Tanning* to record the tanning procedure.
  - Resources for researching brain tanning. Encourage students to find their own resources. Here are some suggested resources to begin with:
    - *Hide Tanning the Woods Cree Way*. Video, 17 minutes. Portage College, 2014. Online at <https://youtu.be/SWUCC00yGd8>. Students will note that the Elder who demonstrates the tanning combines traditional

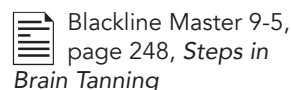

## UNIT 9 • HUNTING AND TRAPPING

chemicals and tools with some modern additions.

- *The Ancient and Arduous Art of Brain Tanning Buffalo Hides*. Gene Gade. Online article at <https://bit.ly/2SgEYfA>. This is a US-based article which focusses on tanning bison, but is applicable to other animals. It includes an explanation of the chemistry of using brains for tanning.
  - Southern Dakelh tanning methods are discussed in the book *Dakelh Keyoh: The Southern Carrier in Earlier Times* by Elizabeth Furniss. See pages 33-34.
  - *Experiments In Hide Brain-Tanning With A Comparative Analysis of Stone and Bone Tools*. Matthew Richter and Darby Dettloff. <https://bit.ly/2DX9VAj>. A US scientific study investigating traditional methods of brain tanning.
  - Note that many online websites and videos about brain tanning are by non-Indigenous trappers who sometimes characterize the process as “primitive.” If students come across such a reference it will be a good opportunity to discuss the sophistication of the techniques and the vast amount of scientific understanding and knowledge that is involved.
  - Students could work together to illustrate the steps and make a class display.
- c. Ask students to identify the scientific knowledge and skills required for brain tanning.

Blackline Master 9-1  
**Mammals of BC**

beaver	fisher	otter
bison	fox	rabbit
bighorn sheep	grizzly bear	sea lion
black bear	lynx	sea otter
bobcat	marmot	seal
caribou	marten	thinhorn sheep
cougar	mink	weasel
coyote	moose	whales
deer	mountain goat	wolf
elk	muskrat	wolverine

## Mammals of BC - Classified

### **Furbearers**

beaver  
bobcat  
coyote  
fisher  
fox  
lynx  
marmot  
marten  
mink  
muskrat  
otter  
rabbit  
weasel  
wolf  
wolverine

### **Big Game**

bighorn sheep  
bison  
black bear  
caribou  
cougar  
deer/elk  
grizzly bear  
moose  
mountain goat  
North American bison  
thinhorn sheep

### **Marine Mammals**

sea lion  
sea otter  
seal  
whales

## Traditional Hunting and Trapping Technologies

First Peoples of BC used a variety of technologies for hunting and trapping animals before guns and steel traps became widespread. The methods used depended on where the people were located, and the type of animals they were harvesting.

bow and arrow
corrals and fences
club
deadfall traps
nets
pitfall trapping
slings
snares
spear

## Deadfall Trap Examples

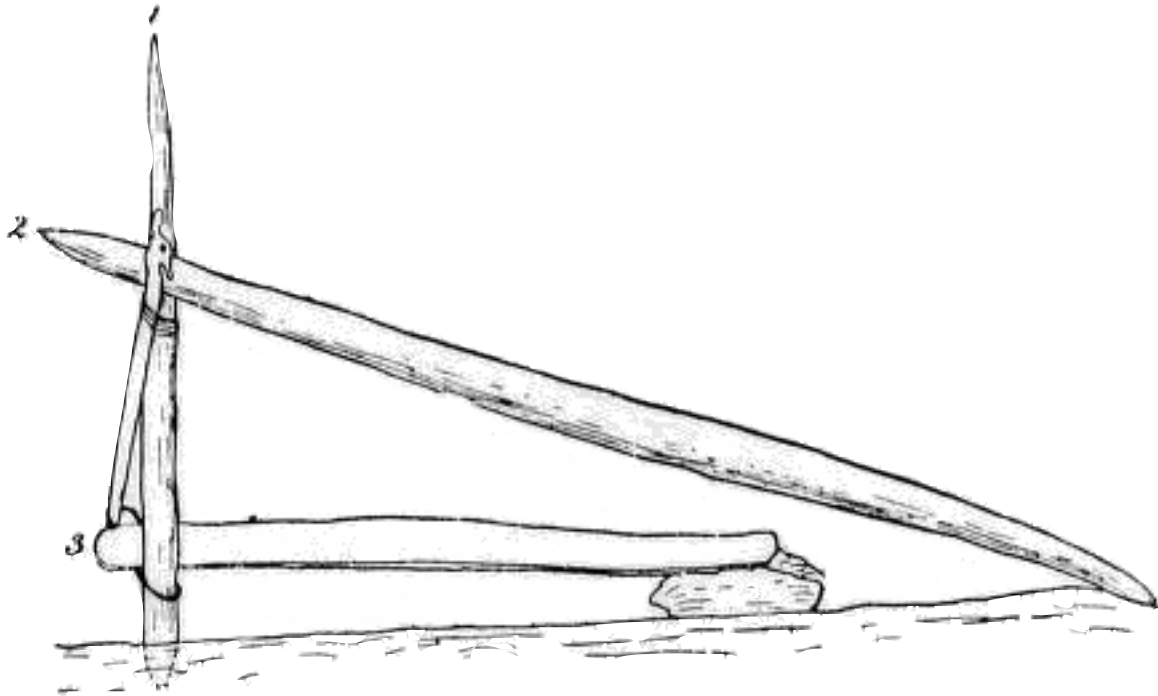

### **Tssetsaut Marmot trap**

Marmots are caught by means of traps of simple construction. A stick, the end of which is carved in the shape of a blue jay, crane or some other animal is tied to a longer stick, which is placed upright in the ground (1).

A heavy club-shaped stick (2) is laid over the place where the two stices are tied together, pressing on the head of the carved stick. The lower end of the latter is held to stick 1 by means of a loop. The lower end of stick 2 is burdened with heavy stones. A small flat stick or board (3) is placed over the loop, and lies in the entrance to the marmot hole. This board is covered with dirt and grass, and as soon as the animal steps on it the loop slips down stick 1, the heavy stick falls down and breaks its back. All these sticks are painted red, and are then covered with stones and grass. They also bear property marks.

Source: Franz Boas. *Tenth report on the North-Western Tribes of Canada*.  
British Association for the Advancement of Science. 1895. Pages 42-43.

## Haida Marten Deadfall

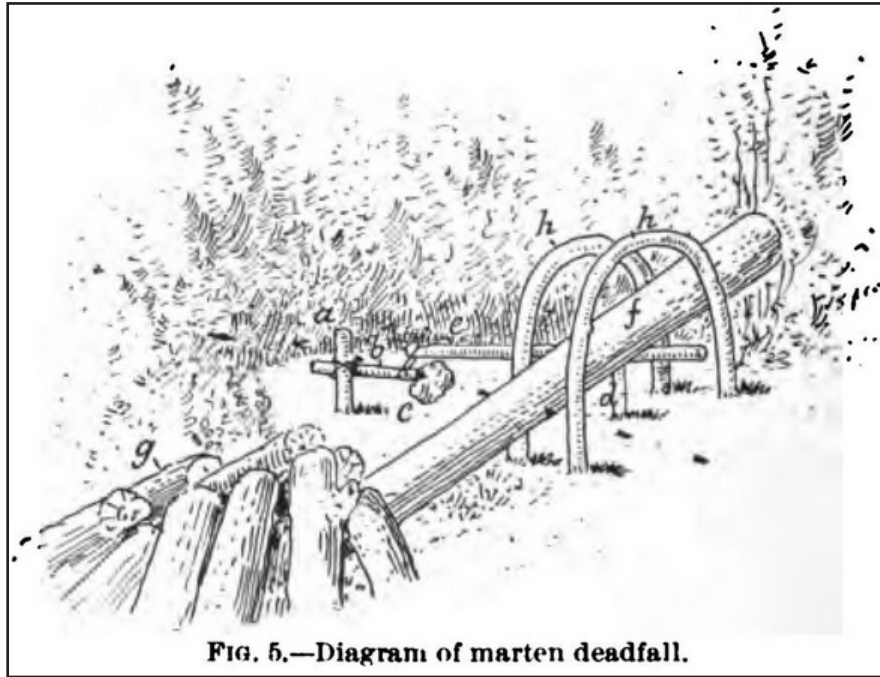

FIG. 5.—Diagram of marten deadfall.

A stake (*a*) was driven into the ground, and a small stick (*b*) carrying the bait (*c*) at one end was fastened to this about midway up. Another stake (*d*) was then driven into the ground some distance in front of these and to one side. Over the top of this another stick was laid extending toward the bait. At that end it was held to the stick *b* by a noose lying in a notch just back of the bait. The bait was also fastened to this noose. The other end of the stick *e* supported one end of the stick *f*, which constituted the dead fall proper. This was weighted along the end *g* next to the ground; and it also had four posts (*h*) to guide it in its descent. They were curved over from each side and fastened together at the top. To prevent the animal from approaching the bait in any other way similar stakes were continued up to and around it. Now, when the bait was pulled off, the noose came away from its notch, whereupon the stick *e* flew up, letting *f* down upon the animal's back. The Haida name for *d* is *x.ā'ña k'udjigā'ño*; for *e*, *x.ā'ña-i*; for *f*, *sí'txa sqā'gida*. The weights are called *qeng.āā'ño*.

## Steps In Brain Tanning

Skins are often prepared using plants that contain tannin compounds, giving the term tanning. However, Indigenous people in BC, Canada and elsewhere traditionally have used different chemical ingredients. The results provides an exceptionally soft, durable and waterproof leather or hide.

The goals of preparing hides are to remove water from the skin, prevent decay, flexibility make it waterproof.

Technique, materials	Time	Intended results
1. Soaking		
2. Cleaning		
3. Stretching		
4. Fleshing		
5. Scraping and thinning		



## Steps In Brain Tanning, page 2

6. Prepare brain emulsion		
7. Brain treatment		
8. Soaking		
9. Drying		
10. Softening		
11. Smoking		



# Unit 10

## Living Technologies

### Overview

Today, when we think of technology we probably think of the vast array of electrical, electronic and digital technologies that surround us. In BC there are a number of First Nations organizations and Indigenous-run businesses, such as the First Nations Technology Council, that work to ensure that modern technologies are available equitably to First Nations.

However, this unit looks at ancient technologies that were essential for living over millennia and which are in many cases still alive today.

At its core, technology is the application of scientific knowledge and principles to design tools and processes that sustain and enhance life. Over thousands of years, First Peoples have used their scientific knowledge to develop myriad sophisticated technologies based on the plant, animal and mineral resources available to them both locally and through trade.

Naturally, the diversity of the province's First Peoples, and the topography, climate and ecosystems of their lands, means that a great diversity of technologies developed using available materials.

The activities in this unit encourage students to explore some of these technologies, and discover the scientific principles and knowledge that First Peoples applied when developing and using them.

### *Guiding Questions*

- How have First Peoples applied scientific knowledge to design?
- How have First Peoples applied their knowledge of the land to design technologies that ensure a sustainable lifestyle?
- How have First Peoples used their understanding of sound to create musical instruments?

Relevant BC Learning Standards for Senior Secondary Science

Course	Key Content Standards	Key Curricular Competencies
Science 10	<ul style="list-style-type: none"> <li>• Practical applications and implications of chemical processes, including First Peoples knowledge</li> <li>• Potential and kinetic energy</li> <li>• Transformation of energy</li> </ul>	<p>Questioning and predicting:</p> <ul style="list-style-type: none"> <li>• Make observation aimed at identifying their own questions, including increasingly abstract ones, about the natural world.</li> </ul> <p>Planning and conducting:</p> <ul style="list-style-type: none"> <li>• Collaboratively and individually plan, select and use appropriate investigation methods, including field work and lab experiments, to collect reliable data.</li> </ul> <p>Processing and analyzing data and information:</p> <ul style="list-style-type: none"> <li>• Experience and interpret the local environment</li> <li>• Apply First Peoples perspectives and knowledge, other ways of knowing and local knowledge as sources of information</li> <li>• Use knowledge of scientific concepts to draw conclusions that are consistent with evidence</li> </ul> <p>Evaluating</p> <ul style="list-style-type: none"> <li>• Consider social, ethical, and environmental implications of the findings from their own and others' investigations</li> </ul> <p>Applying and innovating</p> <ul style="list-style-type: none"> <li>• Contribute to finding solutions to problems at a local and/or global level through inquiry</li> </ul> <p>Communicating:</p> <ul style="list-style-type: none"> <li>• Express and reflect on a variety of experiences, perspectives, and worldviews through place.</li> </ul>
Chemistry 11	<ul style="list-style-type: none"> <li>• Organic compounds</li> <li>• Applications of organic chemistry</li> <li>• Local and other chemical processes</li> </ul>	
Physics 11	<ul style="list-style-type: none"> <li>• Simple machines and mechanical advantage</li> <li>• Applications of simple machines by First Peoples</li> <li>• Characteristics of sound: pitch, volume, frequency, harmonics and beat</li> <li>• Resonance and frequency of sound</li> </ul>	
Physics 12	<ul style="list-style-type: none"> <li>• First Peoples knowledge and applications of forces in traditional technologies</li> </ul>	

## UNIT 10 • LIVING TECHNOLOGIES

### *Cross-curricular Connections*

#### Applied Design, Skills and Technologies 10

Key Curricular Competency: Evaluate the influences of land, natural resources, and culture on the development and use of tools and technologies

#### *Culinary Arts 10; Food Studies 10*

- First Peoples food protocols, including land stewardship, harvesting/gathering, food preparation and/or preservation, ways of celebrating, and cultural ownership

#### *Textiles 10*

- First Peoples traditional and current textile knowledge and practice

#### *Woodwork 10*

- Importance of woodwork in historical and current cultural contexts of First Nations, Métis, or Inuit communities, and other cultural contexts

#### BC First Peoples 12

- Impact of historical exchanges of ideas, practices, and materials among local B.C. First Peoples and with non-indigenous peoples

## Resources

For further information on these resources, see the annotations in the Bibliography, beginning on page 273.

### *Suggested Resources*

- Models and replicas of traditional First Peoples technologies. Check with your District Aboriginal Education department.
- Amaron, Beryl. *More Than Useable Tools: Towards an Appreciation of Nt̓e?kepmx Fibre Technology as a Significant Expression of Culture*. UNBC Masters Thesis 2000. <https://core.ac.uk/download/pdf/84873663.pdf>
- Peacock, Sandra L. “From Complex to Simple: Balsamroot, Inulin, and the Chemistry of Traditional Interior Salish Pit-Cooking Technology.” *Botany* v. 86, 2008. Pp 116-208. Online at <https://bit.ly/2WtySyP>
- *How to Make a Traditional Coast Salish Drum: Jorge Lewis Drum Maker*. Phil Ives, 2012. 20:58 min. <https://youtu.be/3uzmBCZUx0w>

### *Additional Resources*

- Nisga’a Nation. *From Time Before Memory*. SD 92 (Nisga’a), 1996.
- Olsen, Sylvia. *Working With Wool*. Sono Nis, 2010.
- Stewart, Hilary. *Indian Fishing*. Douglas & McIntyre, 1977. Reprinted 2018, Quadra Recreation Society.

## UNIT 10 • LIVING TECHNOLOGIES

- Stewart, Hilary. *Stone, Bone, Antler and Shell. Artifacts of the Northwest Coast*. Douglas & McIntyre, 1996.
- Stewart, Hilary. *Cedar: Tree of Life to the Northwest Coast Indians*. Douglas & McIntyre, 1984.
- Tepper, Leslie H. *Earth Line and Morning Star. Nlaka'pamux Clothing Traditions*. Canadian Museum of Civilization, 1994.
- Turner, Nancy J. *Plant Technology of First Peoples in British Columbia*. Royal British Columbia Museum Handbook series. UBC Press, 1998.
- Turner, Nancy J., Marianne Boelscher Ignace, and Ronald Ignace. "Traditional Ecological Knowledge and Wisdom of Aboriginal Peoples in British Columbia." *Ecological Applications* 10.5 (2000): 1275-287. Available online at <http://bit.ly/2cVwEOM>

### **Blackline Masters**

- 10-1 Traditional Technologies for Living
- 10-2 Frequency of Sounds Lab
- 10-3 First Peoples Technologies for Living
- 10-4 Digging Stick Technology
- 10-5 Pit Cooking Balsamroot

### **Outline of Activities**

- 10.1 First Peoples Technologies: An Introduction
- 10.2 The Sounds of Drums
- 10.3 The Physics of Living Technologies
- 10.4 The Chemistry of Balsamroot
- 10.5 Topics for Inquiry

## Suggested Activities

Note: There are more activities here than most teachers will incorporate into their units. It is not expected that you will use all of the activities, or follow the sequence as it is described. These activities are intended to be adapted to fit the needs of your students and classroom, as well as inspire ways that you can respectfully include relevant Indigenous knowledge and perspectives in your course.

### Activity 10.1

#### First Peoples Technologies: An Introduction

- a. Begin the unit by showing or demonstrating a unique technology that is or has been used by First Peoples in your region. Pose questions that asks students to think about how First Peoples understood and applied scientific ideas to this technology.
  - Where possible, choose an example of technology that will grab students' interest. Ideally they will be able to experience the technology through a real life example or model. This may involve a field trip to a cultural centre, museum or other locale. If that is not possible, have pictures and diagrams to illustrate the technology.
  - Technologies could include one of the following:
    - Traditional drum (How would you know what materials to use to get a good sound?)
    - Monumental pole/totem pole (In the past, how was the tree felled and transported? How was the pole raised?)
    - Longhouse or big house (How did people make planks in the past? How did they raise the house posts?)
    - Pit house (How were they designed for stability (not collapse)? How did their design include thermal properties to keep them livable through the winter?)
    - Spindle whorl (What principals of physics are used?)
    - Bow and arrow (What are the best materials to use? How do you make sure it shoots accurately?)
    - Animal traps (How are physics and animal behaviour understood and applied?)
    - Tasting food that has been processed using traditional methods, such as oolichan grease, pemmican, dried salmon, dried berry cakes (What processes were used to preserve the food?)
    - Canoes (Why were certain materials used? How was the canoe designed for its purpose?)

## UNIT 10 • LIVING TECHNOLOGIES

- clothing and footwear made of tanned hides (How do you make an animal skin soft and waterproof?)
- basketry (How do you know what plants to use? How do you prepare the plants for weaving into baskets so they won't break?)
- After students have had a chance to experience or observe the example of First Peoples technology, discuss what students know or can infer from it. The questions you ask will depend on what the technology is, but here are some samples:
  - What problem or need was it designed for?
  - How essential was it to the lives of the people who used it?
  - How did it make use of locally available resources?
  - How did it contribute to sustainability or food security?
  - What traditional ecological knowledge is necessary to make and use it?
  - What scientific principles are used in technology?
  - How does it use simple machines?
- b. You may want to use Blackline Master 10-1, page 266, *Traditional Technologies*, to help introduce the topic of First Peoples Technologies.
  - Ask students to suggest or predict what each of the technologies are, and what they were used for in the past.
  - The items shown are: 1. fire drill 2. digging stick 3. adze 4. tweezers 5. spindle whorl 6. arrow or spear head 7. pole, poling canoe (or canoe)
  - Use some of the questions in part a. above to discuss these technologies.

 Blackline Master 10-1,  
page 266, *Traditional  
Technologies*

## Activity 10.2

### The Sounds of Drums

---

Students investigate First Peoples' understandings of the properties of sound through an exploration of the construction of drums and other instruments such as rattles.

#### a. Sounds of the Land

This activity gets students outside and into their local environment. It allows them to relate place to learning. It helps students to understand how important land is to First Peoples and that understanding and land go together.

- Take students on a Sound Walk in one or more areas around the school to observe the sounds they hear. Ideally you will pass through an urban or developed area and a field or forest so students can experience different soundscapes.
- If it isn't possible to go on a walk, ask students to reflect on sounds they hear around their home, on their way to school, or other notable soundscapes they may have experienced.
- Using the video *Sounds of BC* (<https://youtu.be/k0aErt4UPXQ>) have

 Land-based activity  
Sound Walk



## UNIT 10 • LIVING TECHNOLOGIES

- students listen to a variety of natural sounds from around BC. You can have them just listen to the sounds first to see how many they can identify.
- Ask students to share a sound from nature that is meaningful to them. If possible, students could create a sound recording or a short video demonstrating the sound and explaining why it is meaningful to them.
    - For an example see the short video Meaningful Sound, <https://youtu.be/Fzz5P4U2DWw>
    - Give students an opportunity to share their sounds with the class or other students.
    - Have students reflect on the sound they chose and what it means to them.
- b. Drum: Heartbeats of Culture. Give students an opportunity to learn about the importance of drums to the local First Nations community, and to other Indigenous and non-Indigenous cultures.
- If possible, invite an Indigenous drummer to demonstrate and discuss the importance of drumming.
    - Students can prepare questions to ask, such as how drumming is used in the guest's culture, the materials used to make it, how they are made, how long a drum lasts, etc.
  - Work with students to find out what types of drums have been traditionally used in your region. Most First Peoples make variations on the traditional form of a hide stretched over a wooden ring, but some use other shapes, and some use large box drums or planks.
    - Students can find images of different types of drums in Hilary Stewart's book *Cedar*. They can use the index to find references to drums.
    - Investigate how they are similar and different from drums in other parts of the province, country, or around the world.
    - If possible learn the word for drum and associated vocabulary such as drum stick or beater in the local First Nations language.
  - Discuss what materials are used in these different drums. Ask, Why do you think these materials are chosen?
- c. Ask students to identify the skills and scientific understandings that are required to build and use traditional drums.
- Students can view a video of contemporary drum maker Jorge Lewis of the Snuneymuxw (Nanaimo) First Nation demonstrating how to make a traditional drum.
    - See *How to Make a Traditional Coast Salish Drum: Jorge Lewis Drum Maker*. Phil Ives, 2012. 20:58 min. <https://youtu.be/3uzmBCZUx0w>
    - Discuss with students the ideas that Lewis explains about the personal energy that goes into the drum, starting about the 12:55 minute mark. For example, if you get impatient, those feelings go into the drum. He explains that the materials of the drum were once living beings animals

 **Cross-Curricular Link**  
In Social Studies courses, student can connect the importance of First Peoples' cultural revival through drumming, storytelling, and singing.

 **Video**  
How to Make a Traditional Coast Salish Drum: Jorge Lewis Drum Maker.

## UNIT 10 • LIVING TECHNOLOGIES

and trees, and as living entities, they have the ability to absorb personal energies.

- Discuss how Lewis combines traditional and contemporary technologies to make the drum. For some of the modern tools used, students can suggest what types of tools might have been used in the past. (For example, the plastic bucket for soaking could have been a stream or lake, or a water-tight basket or box. Instead of the steel hammer and punch, drum makers may have used an awl or stone hammer and punch.)
- Have students identify some of the skills that were significant for making the drum. (For example, the way the hide is soaked, the thickness of the hide used for the drum, which side of the hide is used for the drum, how to make the lace, how and where to punch the holes, how to string the lace; how to tighten the drum.)
- Relate these skills to the scientific understandings required to successfully produce a drum. (For example, understanding how the hide will behave to make the best sound; how the stringing of the lace affects the tension of the drum head; how to treat the hide so it doesn't break or fall apart with use.)
- Students can research the skills and knowledge required to gather and prepare the materials used to make a drum.
- Have students illustrate the steps involved in making and using drums, and indicate the types of skills and scientific knowledge required.

 **Unit Links**  
See Unit 9, Hunting and Trapping for activities about tanning hides.

d. Making Sound Visible. Students can conduct a lab activity that demonstrates sound waves. Students build a model membrane covered in salt or sugar and use a bluetooth speaker to make the membrane vibrate.

- There are a number of examples of this lab activity on the internet. One can be found at the Scientific American website. See “Making Sound Waves,” <https://bit.ly/2VOEXGy>
- After conducting the activity, ask students to explain what was happening.
- Have students reflect on their understanding.

e. Sound variations. Pose the questions: How does one musical instrument make different sounds? What needs to change in order for the sound to be different?

- Students can work in groups to discuss different variables that would affect how a drum sounds. These include:
  - Size: Different size of drum makes different sounds. Have students predict which size drum would have the deepest pitch, or highest pitch and why.
  - Materials: Different hides make different sounds. Have student predict which hide would make the deepest, highest sounds and why.
  - Striking location. Where the drumstick meets drum makes different sounds

 **Lab Activity**

## UNIT 10 • LIVING TECHNOLOGIES

- Striking pressure. The strength of the drumstick on the drum makes different volumes
  - Drumstick or beater construction. What materials is it made from? What shape is it?
  - Students can compare one or more drums to observe how these variables are demonstrated in each drum.
  - Students can design an activity to test some of these variables, if the materials are available.
- f. Frequency of sound. Students measure the frequency of sound produced by different drums and different materials.
- Students can follow the directions for the lab using Blackline Master 10-2, page 267, *Frequency of Sounds Lab*.
  - Use the Lab4U Physics app to get frequency vs intensity and amplitude vs time graphs for each drum.
    - How do traditional First Peoples' drum making skills demonstrate an understanding of sound, vibration, pitch and volume?
    - What new questions do you have after doing this lab? If you could extend this lab what else would you like to find out with this equipment? What new hypothesis could be tested?
- g. If possible and appropriate, students could participate in a drum-making activity where they make a drum of their own.
- h. Other instruments. Students could research another instrument commonly used by BC First Nations, such as rattle, whistle, or flute.



### Lab Activity



Blackline Master 10-2,  
page 267, *Frequency of  
Sounds Lab*

## Activity 10.3

### The Physics of Living Technologies

---

Students can analyze a variety of ways that Indigenous technologies use principles of physics. This activity provides some suggestions for topics that students can use to develop their own inquiries.

- a. The technology of the digging stick. Introduce the topic with the example of a simple tool like the digging stick. The digging stick was an essential tool for many First Nations in the past. At first it seems to be a very simple tool, but its use involves a number of types of scientific knowledge to be successful.
  - Students can read about the digging stick on Blackline Master 10-3, page 270, *Digging Stick Technology*.
- b. Many technological devices utilized by First Peoples can be understood as “simple machines” (devices that change the direction or magnitude of a force). More complex devices may consist of 2 or more simple machines configured to carry out a task. The same type of simple machine could be used multiple times, or different types could be used in combination. Students can examine a variety of traditional technologies and analyse how they employ simple machines.
  - The six simple machines are:
    - Lever (fulcrum and lever arm)
    - Wedge
    - Inclined plane
    - The pulley
    - Wheel and axel
    - Screw
  - An engineering analysis of simple machines includes consideration of:
    - The purpose of the machine (to multiply force, or distance)
    - Force: effort (applied force) and output
    - Work: input and output
    - Power: input and output
    - Mechanical advantage
    - Efficiency
  - Students can select one of the technologies that interests them to analyse from the viewpoint of simple machines. Blackline Master 10-4, page 271, *The Physics of Living*, gives some suggestions. The topics included on the Blackline Master are:
    - Transportation Technologies
    - Technologies for Food Sustainability
    - Technologies for the Household and Community
  - Students can build and test a working model of the technology, where possible, or illustrate the uses of simple machines through diagrams.

 Blackline Master 10-3, page 270, *Digging Stick Technology*

#### Resources

Stewart, Hilary. *Cedar: Tree of Life to the Northwest Coast Indians*.

Stewart, Hilary. *Indian Fishing*.

Stewart, Hilary. *Stone, Bone, Antler and Shell. Artifacts of the Northwest Coast*.

Turner, Nancy J. *Plant Technology of First Peoples in British Columbia*

 Blackline Master 10-4, page 271, *The Physics of Living*

## UNIT 10 • LIVING TECHNOLOGIES

- c. First Peoples Architecture. Architecture is important for its material function (e.g. safe housing) and for the cultural life of a community. Various architectural forms prevalent in BC can be understood as addressing different climactic conditions, geography, topography, and cultural and spiritual needs.
- Architecture – Designs and Construction Technologies. Consider design features that are appropriate to the local climate
    - Consider ways that the design contributes to and supports community life and cultural practices
  - Longhouse. Investigate construction techniques that utilize simple machines for moving and hoisting logs
    - Lever/Fulcrum
    - Wedge
    - Torque – using cables to pull, and people and poles to push, generating torque to erect house posts and totem poles
    - Static equilibrium – techniques to ensure the stability and integrity of structures – poles, beams, ropes, tongue and groove connectors
  - Pit house.
    - Investigate engineering design features that contribute to strength e.g. dome shape, stability of the design
    - Investigate design features that are appropriate to local climate (thermal properties in winter vs summer)
    - Consider ways that the design contributes to and supports community life and cultural practices
  - Contemporary Indigenous Architecture
    - Investigate the work and philosophies of Indigenous architects such as those represented here: <https://tinyurl.com/fnesc79>.

## Activity 10.4

### The Chemistry of Balsamroot

---

An import food for many First Nations of the BC Interior is balsamroot. Depending on how it is processed, the root can be used as food or as medicine. Students investigate the sophisticated traditional and scientific knowledge required to produce two different products. They will find out how pit-cooking causes chemical changes.

 Blackline Master 10-5,  
page 272, *Pit Cooking*  
Balsamroot

- a. Introduce the topic of the chemistry of balsamroot by giving background to students, or have students read and discuss the article on Blackline Master 10-5, page 272, *Pit-Cooking Balsamroot*.
- b. Provide students an opportunity to observe some of the characteristics of the balsamroot. If balsamroot grows in your area, you may be able to bring a sample into the class, or have students observe them in the field.
  - Students can view a short amateur video *See Arrow Leaf Balsam Root* that shows the parts of the balsamroot. Healthy Family Variety Channel, 2018. 5:27 min. <https://youtu.be/ASJ4WTENynM>.
  - Students can find botanical information at the online database E-Flora, <https://tinyurl.com/fnesc67>.
  - Students can read a short article with pictures at [www.bcfoodhistory.ca](http://www.bcfoodhistory.ca). See “Cariboo Sunflowers,” Mary Leah De Zwart, 2017. Linked at <https://tinyurl.com/fnesc75>.
  - The balsamroot is discussed in a case study in this article: “Traditional Ecological Knowledge and Wisdom of Aboriginal Peoples in British Columbia.” by Turner et al. (*Ecological Applications* 2000). Available online at <http://bit.ly/2cVwEOM>
- c. What is inulin? Inulin is a major component of balsamroot that makes the plant indigestible.

**Background:** Inulin is a polysaccharide made up of fructose chains. Many plants use it as a way of storing carbohydrates. As a dietary fibre it is indigestible to humans. It is considered a pre-biotic as it feeds some bacteria in the gut. It is consumed naturally in foods we eat, and sometimes used in supplements to aid digestive health and as a food additive.

- Have students research to find out the chemical structure and properties of inulin.
- Students can determine what is the chemical reason for inulin being indigestible to humans. (The type of chemical bond formed between the fructose molecules; a type of glycosidic bond.)
- Students can work together to compile a list of common plants that contain inulin.

## UNIT 10 • LIVING TECHNOLOGIES

- Ask students to predict what chemical changes would need to take place when balsamroot is cooked to make it digestible. (For example, the chemical bonds need to be broken.)
- d. Students investigate the traditional method of pit cooking balsamroot, and how the processes involved cause the chemical changes required to convert inulin to digestible sugars. As a primary resource students can use the scientific paper by Sandra L. Peacock, “Complex to Simple: Balsamroot, Inulin, and the Chemistry of Traditional Interior Salish Pit-Cooking Technology.” Online at <https://bit.ly/2WtySyP>.
- Pages 118-120 of the document describe the traditional methods of pit-cooking balsamroot. One is a description from 1900 by ethnographer James Teit; the other is a more contemporary description by an Elder (page 120). Page 119 shows a diagram of an earth oven.
  - Students can work in pairs or groups to analyze the descriptions and list or diagram the steps involved in preparing and processing the balsamroot.
    - Have students suggest or identify key parts of the process that might play a role in causing the chemical changes in the inulin.
  - Have students identify traditional knowledge and skills required to successfully produce edible foods from balsamroot in large quantities.
  - If possible, have students develop experimental activities that model the slow cooking of inulin containing plants and test for chemical changes.
- e. Student can also investigate the whole other chemistry when balsamroot is used as medicine. The roots and leaves have been shown to have antimicrobial qualities. However, they can be toxic if taken in large quantities.
- An interesting scientific investigation into the dual nature of the balsamroot was studied by Secwepemc scientist Kelly Bannister in her doctoral thesis.
    - Kelly Patricia Bannister. Chemistry Rooted in Cultural Knowledge: Unearthing the Links Between Antimicrobial Properties and Traditional Knowledge in Food and Medicinal Plant Resources of the Secwepemc (Shuswap) Aboriginal Nation. Doctoral thesis, UBC, 2000. Linked at <https://bit.ly/2dyksEs>.

 Sandra L. Peacock, “Complex to Simple: Balsamroot, Inulin, and the Chemistry of Traditional Interior Salish Pit-Cooking Technology.” Online at <https://bit.ly/2WtySyP>

## Activity 10.75

### Topics for Inquiry

---

There are many other areas of technology that can be investigated in science classes. Here are a few suggestions

#### a. Appropriate Clothing

The geography, climate and available resources dictated diverse materials and designs of clothing for BC First Peoples in the past. Each type of clothing required a unique set of skills and knowledge to provide appropriate clothing for daily life and also for ceremonial and spiritual needs.

- Students can investigate the types of materials that are used to make traditional clothing. The main categories are:
  - furs
  - skins and hides
  - woven fibre from plant materials, such as bark from cedar and other trees, reeds and grasses, stinging nettle.
  - hair such as mountain goat, woolly dogs
- Students can select one of the materials, or a particular type of traditional clothing from a specific area, and investigate the technologies, skills and knowledge that were required to produce them. They can consider questions such as:
  - What are important qualities of different animal skins?
  - What are the insulating properties of skin and furs?
  - What qualities of plant material are needed to make fibres?
  - How was clothing designed to deal with the local climate?
  - How was clothing made waterproof?
  - How did First Peoples make the best use of available materials?
  - How do you transform cedar bark into soft fibres for weaving?
  - How do you use a spindle whorl for spinning fibres?
- Some resources are:
  - Tepper, Leslie H. *Earth Line and Morning Star. Nlaka'pamux Clothing Traditions*. Canadian Museum of Civilization, 1994.
  - Nisga'a Nation. *From Time Before Memory*. SD 92 (Nisga'a). 1996. See Chapter Three: Am'ugithl Nisga'a: Nisga'a Clothing, pages 105-142.
  - Olsen, Sylvia. *Working With Wool*. Sono Nis. 2010.
  - Beryl Amaron, "More Than Useable Tools: Towards an Appreciation of Nl̓eʔkepmx Fibre Technology as a Significant Expression of Culture" (UNBC Masters Thesis 2000).  
<https://core.ac.uk/download/pdf/84873663.pdf>
  - See Unit 2, Activity 2.6, The Story of the Salish Woolly Dog for additional resources.
  - See Unit 9, Hunting and Trapping, Activity 9.5, The Chemistry of



## UNIT 10 • LIVING TECHNOLOGIES

Tanning, for activities about preparing furs and skins.

### b. Food Processing Activities

First Peoples processed many types of foods to store for winter supplies and for trade with other Nations. Each type of processing required a knowledge of the food itself and how it would respond to

- Oolichan grease. The oolichan (eulachon) was an extremely significant fish in the past, and still is today, although its numbers are greatly reduced. The small oil-rich fish is rendered into one of the most prized foods and valuable trade goods, commonly known as grease.
  - Students can research the steps required to make oolichan grease, and infer the skills and knowledge required to make it successfully.
  - Some resources are:
    - Sinumwack: Bella Coola Oolichan Run. UBCIC, 1978. 19:59 min. [https://youtu.be/sZYRl\\_4v2B4](https://youtu.be/sZYRl_4v2B4). This video shows a harvesting and processing camp in Bella Coola (Nuxalk) in 1978. It gives a good explanation of the process, and the reasons for the steps, as well as discussing ways that oolichan grease is made.
    - *Eulachon past and present*. Megan Felcity Moody. Masters Thesis, UBC, 2008. Linked at <https://tinyurl.com/fnesc74>. This thesis examines the oolichan (eulachon) in broad terms in communities along the coast, and with a specific focus on the Nuxalk First Nation. See pages 76-80 for a discussion of the processes in making the grease.
    - “Making Eulachon Grease in Kemano.” Living Landscapes, Royal BC Museum, 2006. Linked at <https://tinyurl.com/fnesc73>. This website is a photo gallery of an oolichan harvesting and processing camp in Kemano.
    - *T’Lina: The Rendering of Wealth*. Nimpkish Wind Productions, 1999. 50 min. This feature documentary by Kwakwaka’wakw filmmaker Barb Cranmer tells of the traditional oolichan harvest and processing on Knight Inlet, and the depletion of the oolachon. It may be available from your Resource Centre or community library.
- Drying and Smoking. Many different methods of drying and smoking foods were used. Students can investigate the diverse types of scientific knowledge need to ensure that the meat, berries and other foods were dried properly and did not go bad over the winter.

# Traditional Technologies for Living

1.

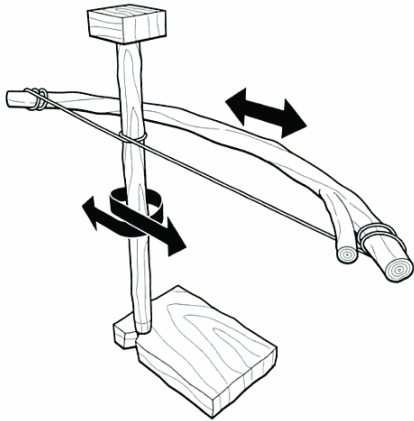

2.



3.

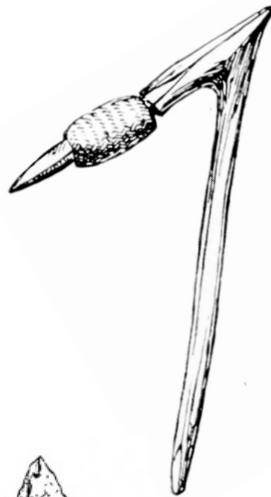

4.

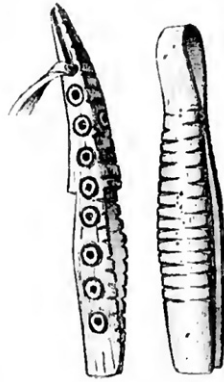

5.



6.



7.

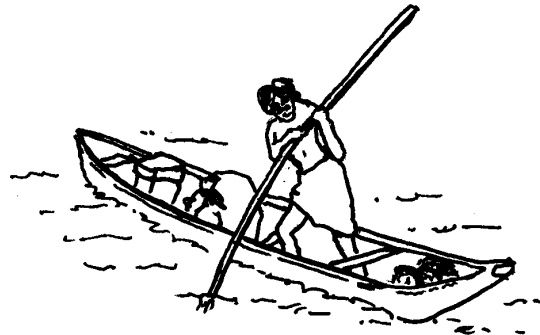

# Frequency of Sounds Lab

Please read over the lab and write your hypothesis in the space provided on this worksheet before starting the lab video.

## Overview

This lab is an investigative lab in which you will verify how frequency is related to pitch and how different drum sizes and materials produce different sounds. You will also look at rattles and how their materials effect the sound that is produced.

Every sound has its source in a vibrating object. What vibrates depends on the object that is making the noise. Vibrating objects send energy through waves into the surrounding air. The human eardrum passes those vibrations through to the middle and inner ear where tiny hair cells change the vibrations into electrical signals that are sent to the brain. The brain tells you that you are hearing sound and what that sound is.

The human ear can detect sounds ranging from approximately 20 Hz to 200000 Hz. Below is a portion of a piano keyboard and the frequencies those keys produce.

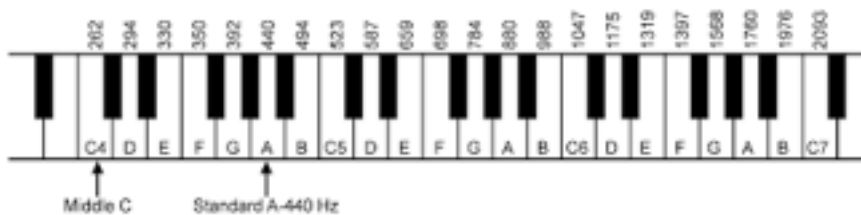

What does it mean to say that one note is higher than another? What happens to a sound's frequency when you increase its pitch?

## Objectives

- To experimentally determine how different sizes of drums and different materials of drums affect the frequency of sound produced by that drum.
- To experimentally determine how a rattle produces different frequency of sound and how the amplitude vs time graph for a rattle is different from that of a drum.

## Materials

- Cell phone with Lab4Physics app using Sonometer
- 2 handmade drums with drumsticks
- 3 different handmade rattles.

**Write your Hypothesis:**

For this lab, write a hypothesis below. You may use the “If ... then ... because ...” format.

Predict which drum material and size you think will have the highest and lowest pitches. Explain why you think so.

**Procedure**

1. Turn on Lab4Physics app on your cell phone. Go to tools and choose Sonometer.
2. Click “New measurement”
3. Press “Go” button
4. Beat one drum once with the drumstick
5. When recording stops three result options are presented. “Amplitude vs. Time”, Frequency, and “Intensity vs Frequency”. Click on Save Data.
6. Precisely name the data so as not to confuse it later.
7. Measure the diameter and thickness of the drum and record it in Table 1.
8. Record the type of material used to make the drum in Table 1.
9. Record the frequency of the drum in Table 1.
10. Repeat steps 2 – 9 for the other drum. Record your data in Table 1.
11. Repeat steps 2 - 7 and steps 8 - 9 for three different rattles. Record your data in Table 2.

**Discussion Questions**

1. What is producing the sound?
2. What diameter of drum tends to produce a higher pitch sound?
3. What diameter of drum tends to produce a lower pitch sound?
4. How are pitch and frequency related?
5. Why does the Sonometer app produce such a different amplitude vs time graph for the rattles than it did for the drums?
6. Evaluate your hypothesis. Make sure you use your results to refute or verify your hypothesis.

**Conclusion**

In one or two sentences, summarize the key findings of the lab.

# Blackline Master 10-2 Page 3

## Data Recording

Table 1: Drum size and composition compared to frequency of sound produced.

Drum Description			Peak Frequency:(Hz)
Diameter (cm)	Thickness (cm)	Material	

Table 2: Rattle composition compared to frequency of sound produced.

Rattle Description		Peak Frequency (Hz)
Outside Material:	Inside Material:	

## Digging Stick Technology

Digging sticks were one of the most important tools in many First Nations communities in the past. They use a simple yet elegant technology.

The digging stick was an essential part of a woman's toolkit for many First Nations who harvested large amounts of roots and bulbs.

Digging sticks are usually made from hardwood, such as Pacific yew, oceanspray, saskatoon berry and crabapple. Sometimes in the past they were made from antlers of caribou, elk or deer.

Many digging sticks, especially those used by interior First Nations, have a crossbar handle at the top. This could be antler, mountain goat horn or wood. Many sticks used on the coast had a rounded knob at the top.

Often wooden digging sticks were reversible. The handle had a hole drilled to accept one end. The sticks were sharpened at both ends. If the bottom tip became dull during digging, the stick could be pulled out of the handle and reversed so there was a new sharp tip ready to dig.

The tips were not only sharpened. They were also fire hardened in hot coals. This made them last much longer.

The shape of the stick was important, too. If the wood did not have the proper curve, it could be shaped by bending it through a steaming process.

To use the digging stick, it is first pushed down into the soil, then pulled back. It might take one good pull, or pushing and pulling a number of times, to lift up a good clump of roots or bulbs.

In the Stl'atl'imx language the word for oceanspray, a hardwood plant, translates to mean "digging stick plant."

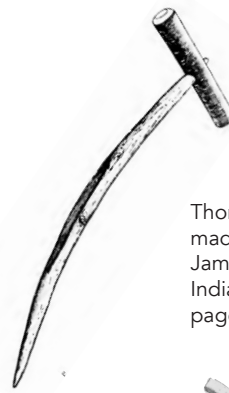

Thompson digging stick made of hardwood. Source: James Teit, *The Thompson Indians of British Columbia*, page 231.



Chilcotin digging stick made of caribou antler. 97 cm long. Source: James Teit, *The Shuswap*, page 513

Once the roots and bulbs have been exposed, the harvester can then pick those that are the best size for harvesting. The sod can then be put back in place, and the remaining plants can continue to grow. This ensures the plants are harvested sustainably.

Digging sticks were used for others purposes as well. They could be used for weeding areas where root plants were grown, excavating for house pits or pit ovens, and, on the coast, for digging clams.

Digging sticks were usually used by women. For a woman, they were very personal items. They were made specially for her, and matched her height and how she would use it.

The handles were often decorated with designs that had special meaning to her. When she died, her digging stick might be buried with her, or used to mark her grave.

## The Physics of Living

For thousands of years First Peoples of Canada developed many sophisticated technologies to sustain and enhance their lives. Here are some of the technologies that you can investigate.

### Transportation Technologies

#### Canoes

- Consider various styles of canoe. Investigate advantages and disadvantages of each canoe design in light of the intended material and cultural purposes. For example, consider buoyancy and maneuverability (torques) needs in different conditions, such as location (e.g. ocean vs river vs lake) or use (e.g. transportation vs fishing vs food harvesting)

#### Paddles

- Analyze as a lever
- What are the advantages and purposes of different shapes of paddle?
- Investigate paddles in relation to force, work, energy, power

#### Poling (rather than paddling) canoes

- Analyze in terms of torques

### Technologies for Food Sustainability

- These include technologies for hunting, fishing, and agriculture. They can be analyzed as simple machines such as wedges, and levers. Also analyze the forces of torque.
- Digging stick
- Fish hooks
- Fishing and hunting spears
- Fish club
- Bow and arrow

### Technologies for the Household and Community

Analyze these tools and techniques as simple machines:

- Tools for woodworking
  - Hammer: hand and hafted maul – analyze as levers (mechanical advantage)
  - Wedge
  - Adzes and chisels
- Techniques for felling trees
- Techniques for splitting planks
- Technique for starting fires: Fire drill (torque and energy transformations)
- Spindle whorl for spinning fibres

## Pit-Cooking Balsamroot

The arrowleaf balsamroot (*Balsamorhiza sagittata*) is a plant in the sunflower family that grows abundantly in western North America.

All parts of the plant can be used. In the past, the leaves, stems, shoots and seeds were eaten or used as medicine. But the most important part was the taproot.

The root of the balsamroot is an important food source for many BC First Nations of the interior and in the Fraser Valley. In the past it was a staple food that provided nutrition and energy throughout the year. As well, it provides a useful medicine.

Using the taproot is labour intensive. It is not easy to dig, and has to be peeled, a difficult and time consuming job.

A main component of the taproot is the carbohydrate inulin. However, inulin is indigestible by humans. How could the root become a staple food source if most of it is indigestible?

Indigenous people perfected a cooking technology that converted the inulin to simple sugars, making the root not only taste better, but become digestible and provide available energy sources.

This technology is the earth oven or pit-cooking which involves a slow cooking period in an enclosed pit in the ground.

There are a number of essential conditions that need to be met to successfully produce the edible food.

These include:

- adequate temperature for a sustained period of time, provided by fire-heated rocks
- adequate moisture, provided by steam from water added at a specified point in the cooking process
- adequate acidity, provided by volatile organic acids emitted by moistened plants added to the pit



## PART THREE

# BIBLIOGRAPHY

This bibliography include resources listed in each of the units as well as supplementary resources. They are listed by category:

1. Traditional Narratives
2. Teacher Resources: Pedagogy and Classroom Activities
3. Plant Guides and Handbooks
4. Videos
5. Interactive Websites
6. Everything Else

## 1. Traditional Narratives

Bridge, Karen and Kevin Neary. *Voices of the Elders. Huu-ay-aht Histories and Legends*. Heritage House, 2013.

A history of the Huu-ay-aht people of the west coast of Vancouver Island, including chapters on the traditions about the Great Flood and earthquakes.

Carlson, Keith Thor. *You Are Asked to Witness: The Stó:lō in Canada's Pacific Coast History*. Stó:lō Heritage Trust. Chilliwack, BC, 1997.

This ethnohistory of the Stó:lō contains an Elder's description of a First Salmon Ceremony and other information related to traditional salmon fishing (pages 3-7).

*Kou-Skelowh / We are the People*. Theytus Books, 1999.

This book contains three Okanagan traditional narratives: How Food was Given (Led by Grizzly Bear, the plants and animals promise to sacrifice themselves to provide food for humans); How Names were Given (Animals are given roles before the arrival of humans) and How Turtle Set the Animals Free (Turtle outsmarts Eagle to free the animals).

Ktunaxa Nation Creation Story. Ktunaxa Nation website.

<http://www.ktunaxa.org/who-we-are/creation-story/>

In preparation for the arrival of humans, the animals chase a terrible monster through the Ktunaxa territory. The story of the chase names places throughout the region. Events following the defeat of the monster end up creating physical features, including the Rocky Mountains.

## BIBLIOGRAPHY

Morven, Amelia. *When the Volcano Erupted*. Amelia Morven, Nisga'a Elder.

This story told by Nisga'a Elder Amelia Morven tells of how children mistreated the salmon, which resulted in the eruption of a volcano and the destruction of many people and villages. Found in *First Nations Journey of Justice*, Grade 5, pages 143-146. Online at <https://bit.ly/2CQCO1H>.

Nisga'a Lisims Government. *Volcano*. <http://www.nisgaanation.ca/volcano>.

This website gives a version of the traditional story about the Nass valley volcano.

Sechelt Nation. *Mayuk the Grizzly Bear*. Gibsons, Nightwood Editions, 1993.

A Sechelt Elder tells a traditional narrative when he gives a name to his great grandson. Two brothers rescue their younger brother from a grizzly bear that they wounded when they were hunting. The baby is not named after the brave hunters, but after the respected foe, Mayuk the grizzly. Contains elements of TEK, such as knowledge of bears' anatomy and use of medicinal plant.

Stó:lō Nation. *Man Turned to Stone* website. Stó:lō Research and Resource Management Centre. Link at <https://tinyurl.com/fnesc90>

Describes the traditional story of the man who was transformed to stone, as well as a background to the importance of stories and the connections with the land.

Tsimshian Nation. *Luutigm Hoon – Honouring the Salmon : An Anthology Told in the Voices of the Tsimshian*. Tsimshian Nation, School District 52 (Prince Rupert) 1999.

Includes traditional stories “The Adawx of the Salmon and the Prince” and “The Origin of Fishing Nets.”

Vickers, Roy Henry. *Orca Chief*. Madeira Park BC: Harbour Publishing, 2015.

When four hunter from Kitkatla arrive at their fishing grounds, exhaustion makes them lazy and they throw their anchor overboard without care for the damage it might do to marine life or the sea floor. When Orca Chief discovers what the hunters have done, he sends his most powerful Orca warriors to bring the men and their boat to his house. The men beg forgiveness for their ignorance and lack of respect, and Orca Chief compassionately sends them out with his pod to show them how to sustainably harvest the ocean's resources.

White, Ellen Rice (Kwulasulwut). *Legends and Teachings of Xeel's, The Creator*. Theytus Books, 2018.

Four traditional narratives presented for high schools students. Includes The Creator and the Flea Lady which includes the theme of Interconnectedness and the understanding that everything is living.

## BIBLIOGRAPHY

*Winter Hunter and the Mosquitoes.* Ts'msyen. Two versions available:

- Franz Boas, *Tsimshian Mythology*, 1916. Available online at <https://bit.ly/2FyD7kD>.
- Canadian Museum of History, condensed version, adapted from the version published by Franz Boas. Online at <https://bit.ly/2Dj9z8d>.

*People of the Land: Legends of the Four Host First Nations.* Theytus Books, 2009.

Narratives of the Lil'wat, Musqueam, Squamish and Tseil-Waututh First Nations published in connection with the 2012 Vancouver-Whistler Olympics. Many photographs illustrate this anthology of the Lil'wat, Musqueam, Squamish and Tseil-Waututh First Nations traditional stories. These stories link people to the land and to each other and pass on traditional knowledge and history. These sacred teachings – which range from creation stories to naming stories – are collected in an anthology of stories shared by storytellers of each nation. The book celebrates the four host First Nations on whose ancestral territories the Vancouver 2010 Olympic and Paralympic Winter Games were held. The stories are summarized below:

The Transformer Story of Lil'wat People: Creation of Lil'wat Territory, pages 13-19.

- Two brothers and their sister, known as the Transformers, shaped the land of Lil'wat people, leaving landmarks that can be identified today. At the same time, they instruct the people on how to harvest resources from the land.

Coyote, (Lil'wat), pages 21-43.

- This story tells different adventures of Coyote, the trickster/transformer character. First, he attempts to create a son out of different materials from the land – mud, rock, pitch and finally cottonwood bark (teaching an understanding of the different properties of these materials). Then Coyote and his son go on a journey and a variety of transformations happen along the way.

The Young Girl That Transformed into a Wolf (Musqueam), pages 49-50.

- A short version of story in which a girl, tired of always having to hunt deer for her family, transforms into a wolf.

Qelqelil (Musqueam), pages 53-68. A Musqueam version of how mosquitoes came to be.

Smwkwa'a7 – The Great Blue Heron (Squamish), pages 75-78.

- The Transformers are preparing the world for the coming of the people, and the transform a grumpy old man into the Great Blue Heron.

Sch'ich'iyúy – The Sisters Mountain (Squamish) pages 81-90.

- This tells the story of the transformation of two sisters into the two prominent mountain peaks visible from Vancouver, called by the Squamish the Sisters, but commonly known by non-Squamish people as the Lions.

Tseil-Waututh Nation Story of Creation, pages 97-101

- The first man and woman are created as a result of transformations of aspects of the natural world.

## BIBLIOGRAPHY

### 2. Teacher Resources: Pedagogy and Classroom Activities

These resources include pedagogical sources that discuss various aspects of infusing Indigenous science in the school curriculum, as well as additional sources of units and lessons.

Aikenhead, G. and H. Michell. *Bridging Cultures: Indigenous and Scientific Ways of Knowing Nature*. Pearson Education, 2012.

Examines ways Indigenous and Western science can be used together to build cross-cultural school science.

Bibby, Maureen and Teresa Laplante. *Ktunaxa Resource Kit Teachers Guide*. Ktunaxa/Kinbasket Language Program, 1994.

These lesson activities include Plant Collecting, Hunting and Fishing, In Camp Activities and Transportation.

Canadian Wildlife Federation. Strangers in a Strange Land. Link at <https://tinyurl.com/fnesc38>

Online activities. Students explore the traditional wisdom of fishers, farmers, First Nations, and other peoples whose close relationship with nature gives them a deeper understanding of, and sensitivity toward, climatic cycles and events.

Climate Justice in BC: Lessons for Transformation. <http://www.teachclimatejustice.ca>

Curriculum package examines climate change and rising inequalities. Includes 8 modules with embedded videos, downloadable graphics, Power Points, print-friendly PDFs, and additional resources is available free to use and adapt.

Great Bear Sea videos and curriculum. A series of video clips based on the documentary *The Great Bear Sea: Reflecting on the Past—Planning for the Future*, and accompanying lessons. [www.greatbearsea.net](http://www.greatbearsea.net).

Ignas, Veronica. *Two Ways of Knowing, Traditional Ecological Knowledge Meets Western Science*. 2003. <http://www.ecoknow.ca/curriculum.html>

Students compare Traditional Ecological Knowledge and scientific knowledge using case studies of Indigenous Plant Classification, the Pine Mushroom Industry in North West British Columbia, the Smallpox Epidemic of 1862 and the impact of AIDS today.

Ignas, Veronica. *Traditional Ecological Knowledge and Climate Change*. 2003. <http://www.ecoknow.ca/curriculum.html>

These lessons are based on primary research done by the Forests and Oceans For the Future Research Group. Elders, harvesters, fishers and other members of the Gitxaala community were interviewed to learn about their understanding of weather and climate in the Gitxaala area.

## BIBLIOGRAPHY

Isaac, Irene. *Understanding Traditional Ecological Knowledge Through Kwakwaka'wakw Story*. Master's thesis, University of Victoria, 2010. Online at <http://bit.ly/2cCercS>

Description of a cross-cultural science and environmental education program using traditional Kwakwaka'wakw stories as a focus. Lessons were piloted in Alert Bay and evaluation showed that the students understood the TEK of the people, and a range of western science concepts, and also respect of the people and the land.

Judson, Gillian. *A Walking Curriculum: Evoking Wonder and Developing Sense of Place* (K-12). 2018. 68 pages.

Suggestions for place-based activities that get students outside and interacting with their environment in diverse ways. For more information see the imagineEd website, [www.educationthatinspires.ca](http://www.educationthatinspires.ca). Direct link at <https://tinyurl.com/fnesc10>.

Kawagley, Angayuqaq Oscar, Ray Barnhardt. "Indigenous to Place: Western Science Meets Native Reality." Alaska Native Knowledge Network. Alaska University, 1998. (19pp) <https://eric.ed.gov/?id=ED426823>

This paper examines the relationship between Indigenous ways of knowing and those associated with Western science and formalized schooling, with examples from Alaska that illustrate ways to reconnect education to a sense of place. Educational applications of four Indigenous views are discussed: long-term perspective, interconnectedness of all things, adaptation to change, and commitment to the commons.

Klockars, Donna and Brenda Boreham. *Legends from the Chemainus Tribe. Stories and Teachings from the Oral Tradition of the Elders*. Chemainus Tribe and First Nations Education Services, SD 68 Nanaimo, 1992.

Cross-curricular lessons around two Chemainus stories, The Wolf Family Legend and Saved by the Orca. (The stories are published separately.) The "Saved by the Orca" unit includes the activities, Canoe and Paddlemaking and Clam Chowder.

*Kokanee of British Columbia*. Wild BC, 2004.

This teacher's guide provides a wide variety of activities for all grade levels. It includes an activity about the evolution of the landlocked kokanee from the sockeye salmon.

*The Learning Circle*. Classroom Activities. Indigenous Affairs Canada, 2012. <https://bit.ly/1MTii1J>

Eight units on various topics relevant to First Nation Studies for ages 12 - 14. Unit 4, Hunting and Trapping, can be adapted to the Hunting and Trapping unit in this Teacher Resource.

## BIBLIOGRAPHY

Lemaigre, Keith. *Trapping*. Unit in the series Rekindling Traditions: Cross-Cultural Science and Technology Units. College of Education, University of Saskatchewan, 2000.

<https://tinyurl.com/fnesc36>.

These lesson plans and activities dealing with trapping were designed for an Indigenous school whose community members are active trappers and includes lessons dealing with the use and physics of steel traps and going out on a trap line.

McKeen, Scott. *First Nations Resource Use on the Northwest Coast: Investigations into Geography, Ecology, Knowledge and Resource Management*.

<http://www.ecoknow.ca/documents/tekUnit3.pdf>

Students examine resource management and environmental issues, and ways that Traditional Ecological Knowledge can be used to address them. It features a resource management simulation.

MacPherson, Nancy Elizabeth. *Traditional Knowledge for Health (Nlaka'pamux)* Masters thesis, UBC, 2009. <http://bit.ly/2dBfaM8>

This thesis studies the TEK of the Nlaka'pamux Nation as it relates to health.

Michell, Dr. Herman, Yvonne Vizina, Camie Augustus and Jason Sawyer. *Learning Indigenous Science from Place*. University of Saskatchewan, 2008. <https://bit.ly/2ENlmMo>.

Research study examining Indigenous-Base Science perspectives in Saskatchewan First Nations and Métis Community contexts.

*Project Caribou. An Educator's Guide to Wild Caribou of North America*. Project Caribou. Whitehorse: Government of the Yukon, 2001. <https://tinyurl.com/fnesc37>

A detailed guide to the caribou, including background information and activities. Includes BC caribou herds.

Safe Drinking Water Foundation. *Grade Nine Thematic Unit: First Nation Water Issues Case Studies*. Safe Drinking Water Foundation website, [www.safewater.org](http://www.safewater.org). Linked at <https://tinyurl.com/fnesc77>.

Four case studies about water issues are presented. The studies are: As long As the Rivers Flows Tour 1991; James Bay I & II; Yellow Quill First Nation; Natural Resource Transfer Agreement.

Snively, Gloria. *Beach Explorations. A Curriculum for Grades 5-10*. Oregon Sea Grant Program, 1998.

This resource includes a great variety of activities to do with beach studies, including suggestions for planning field trips to beaches, biological and ecological information and activities, science inquiries with specific types of seashore animals, and activities for different types of seashore habitats.

## BIBLIOGRAPHY

Snively, Gloria and Wanosts' a7 Lorna Williams, eds. *Knowing Home: Braiding Indigenous Science with Western Science, Book 1*. University of Victoria, 2016.

<https://tinyurl.com/fnesc83>

Snively, Gloria and Wanosts' a7 Lorna Williams, eds. *Knowing Home: Braiding Indigenous Science with Western Science, Book 2*. ePublishing Services, University of Victoria Libraries, 2018. <https://tinyurl.com/fnesc76>

Together these two volumes provide a wealth of support for infusing Indigenous Science and Knowledge into the BC science curriculum. Chapters include background and discussions about Indigenous knowledge and worldviews, and also practical ideas for developing lessons.

Tenning, Cathleen Anne. "Metaphorical Images of Sciences: The Perceptions and Experiences of Indigenous Students who are Successful in Senior Secondary Science." In *Knowing Home: Braiding Indigenous Science with Western Science, Book 2*, pages 29-40. ePublishing Services, University of Victoria Libraries, 2018. <https://tinyurl.com/fnesc76>

A report on a study of Indigenous students who were successful in senior secondary science courses, tracking their perceptions and attitudes about science.

Thompson, Judy. *Traditional Plant Knowledge of the Tsimshian*. 2003.

<http://www.ecoknow.ca/curriculum.html>

Students apply understandings of Traditional Ecological Knowledge to plant identification, classification, traditional cultural practices and nutrition.

Vuntut Gwitchin Government. *Traditions & Science – Spring Culture Camp Teacher Manual*. Old Crow Experiential Education Project, Yukon Government, 2010. Yukon Schools website, link at <https://tinyurl.com/fnesc18>. See the accompanying Grade 7-9 student booklet at <https://tinyurl.com/fnesc19>.

These activities were developed for students attending land-based camps and cover a range of activities associated with traditional knowledge and land use. Include activities useful for Unit 9 Hunting and Trapping. Also includes Aquatic Studies.

Aboriginal Curriculum Integration Project, SD 79 Cowichan Valley. <http://bit.ly/2dkCSaG>

Environmental lessons for Grades 7-9.

Walker, Donna. *First Nations Science & Ethnobotany Unit K-10*. Vancouver Island Region for Aboriginal Education. N.d.

Fifteen activity cards with science and art activities including these plants: salal, miner's lettuce, cow parsnip, salmonberry, sweet camas, red laver, chanterelle mushroom, sphagnum moss, ferns, white fawn lily, lodgepole pine and red cedar, red alder, kinnikinnick, eel grass and oregon grape, cat tails.



## BIBLIOGRAPHY

W̱SÁNEC School Board and Tye Swallow. “Learning from the Homeland; An Emerging Process for Indigenizing Education.” In *Knowing Home: Braiding Indigenous Science with Western Science, Book 2*, pages 186-210. ePublishing Services, University of Victoria Libraries, 2018. <https://tinyurl.com/fnesc76>

This article describes an on-going project to develop local, place-based curriculum working with W̱SÁNEC Elders and community members.

### 3. Plant Guides and Handbooks

MacKinnon, Andy. *Plants of Northern British Columbia*. Lone Pine Field Guide, 1999.

Parish, Roberta. *Tree Book: Learning to Recognize Trees of British Columbia*. Partnership Agreement on Forest Resource Development. Print version, or download online at <http://ow.ly/7DLO302Wa1h>

Pasco, Juanita. *The Living World. Plants and Animals of the Kwakwaka'wakw*. Alert Bay: U'mista Cultural Society, 1998

Pojar, Jim. *Plants of Coastal British Columbia including Washington, Oregon & Alaska*. Partners Publishing, 2016.

Turner, Nancy J. *Food Plants of Coastal First Peoples*. Royal British Columbia Museum, 1995.

Turner, Nancy J. *Food Plants of Interior First Peoples*. Royal British Columbia Museum Handbook series. UBC Press, 1997.

Turner, Nancy J. *Plant Technology of First Peoples in British Columbia*. Royal British Columbia Museum Handbook series. UBC Press, 1998, 2007.

Turner, Nancy J. *Plants of Haida Gwaii*. Sono Nis Press, 2005.

Turner, Nancy J. and Richard Hebda. *Saanich Ethnobotany: Culturally Important Plants of the W̱SÁNEĆ People*. Royal BC Museum, 2012.



## BIBLIOGRAPHY

### 4. Videos

Most of these videos are found online.

*Aboriginal Culture in British Columbia*. 2011 4:32 min. Link at <http://bit.ly/2dCTa2L>

This is a BC Tourism promotional video that might be used as an introduction to the diversity of technologies and cultures of BC First Nations.

*Arrow Leaf Balsam Root*. Healthy Family Variety Channel, 2018. 5:27 min.

<https://youtu.be/ASJ4WTENynM>

An amateur video showing the parts and characteristics of the balsamroot.

*Bear Witness*. Central Coast First Nations Bear Working Group, 2013. 22 minutes. On

Youtube, link at <http://bit.ly/2cjDHBm> or the website [www.bearsforever.ca](http://www.bearsforever.ca)

This video takes a compelling look at the issue of trophy hunting of grizzly bears on BC's Central Coast, while illustrating the relationships of people and bears and the connections First Nations have with the bears and the land. It also shows a strong relationship between First Nations guardians and scientists who share research into bear populations. NOTE: This video includes a number of short but graphic clips of dead bears and bear parts. Preview to make sure it is appropriate for your students.

*Bill Reid*. NFB, 1979. 27:56 min. [https://www.nfb.ca/film/bill\\_reid/](https://www.nfb.ca/film/bill_reid/)

This video from 1979 shows the renowned Haida artist Bill Reid creating a totem pole from a cedar tree.

*Clam Garden Time Lapse*. SFU Newsroom, 2014. 0:36 min.

<https://youtu.be/hqWC5CeVQy8>.

A short view of a clam garden through the changing tides taken on Quadra Island.

*Deadfall Trap*, SKCradleboard Initiative, 2015. 10:52 min. [https://youtu.be/9\\_vKkCoqi5g](https://youtu.be/9_vKkCoqi5g).

The “figure 4” deadfall trap is demonstrated by a First Nations knowledge-keeper.

*Eyes and Ears on the Land and Sea*. Coastal First Nations Great Bear Initiative, 2010. 12 min.

<https://vimeo.com/8317295>

An overview of the activities of the Guardian Watchmen programs in First Nations communities on the North and Central coasts.

*Freedom For the Fry*. Castanet, 2018.1:24 min. <https://bit.ly/2WAUmXa>.

This is a news report and video about the release of salmon fry into the Penticton Channel by students from the Okanagan region, as part of an annual Penticton Indian Band ceremony.

## BIBLIOGRAPHY

*From Glaciers to Glass Sponge Reefs*. Kitsumkalum First Nation, 2018. 27:21 min. Online at <https://youtu.be/15CxqNnFJSw>.

The video shows how one BC First Nation is studying the effects of climate change and finding ways to adapt to the coming changes to ensure they still have access to their traditional food resources. It illustrates how the community uses both traditional knowledge and Western science to understand, monitor and adapt to the changes in their local ecosystems.

*The Guardians of the Land*. St'at'imc Government, 2017. 7:37 min. <https://youtu.be/Zi8g-kyQcGg>.

Members of the St'at'imc First Nation explain the importance of the grizzly bear to their culture, and the effects on the land and the culture of the loss of grizzlies on their territories. Discusses their grizzly bear monitoring program and grizzly recovery project. It also touches on the different relationship that settlers had with the bear. See also, *St'at'imc Grizzly*, St'at'imc Government, 2016

Great Bear Sea videos and curriculum. [www.greatbearsea.net](http://www.greatbearsea.net)

A series of video clips based on the documentary *The Great Bear Sea: Reflecting on the Past – Planning for the Future*, and accompanying lessons. The Youtube play list for the videos is linked at <https://tinyurl.com/fnesc91>.

*Hide Tanning the Woods Cree Way*. Video, 17 minutes. Portage College, 2014. Online at <https://youtu.be/SWUCC00yGd8>.

This video follows an Indigenous Elder tanning a moose hide. It outlines thirteen steps required to tan the hide.

Heath, Joel and the Community of Sanikiluaq. *People of a Feather*. Video. 1 h 32 min.

Documentary film about survival in a changing Canadian Arctic. Available on disk or rental through Vimeo, <https://vimeo.com/ondemand/peoplefeather>.

*How to Make a Traditional Coast Salish Drum: Jorge Lewis Drum Maker*. Phil Ives, 2012. 20:58 min. <https://youtu.be/3uzmBCZUx0w>

Contemporary drum maker Jorge Lewis of the Snuneymuxw (Nanaimo) First Nation demonstrates how to make a traditional drum.

*Imagine the Fire*. CBC The National. 2013. 14.24 min. <https://bit.ly/2UC2u87>

This video about controlled landscape burning reports on how the Dene of the Fort Liard First Nations in north-eastern BC use traditional burning practices to manage its traditional territories.

## BIBLIOGRAPHY

*Indigenous Connections to the Land.* Alannah Young, 2015. 4:37 min.

[https://youtu.be/vxjB\\_c9JqHc](https://youtu.be/vxjB_c9JqHc).

This short video shows Coast Salish people and their connections with the land, including a young girl and her grandmother, and Musqueam elder Larry Grant.

*Kitsumkalum on Climate Change and Food Security.* Kitsumkalum First Nation. 4:37 min.

<https://youtu.be/VZiuUKu0D00>

This is the introduction to the longer documentary, *From Glaciers to Glass Sponge Reefs*.

*Keepers of the Coast.* Coastcast.ca Production. Central Coast Indigenous Resource Alliance.

38 min. [www.vimeo.com/172824819](http://www.vimeo.com/172824819)

Keepers of the Coast takes a close look at how the Kitasoo/Xai'Xais, Heiltsuk, Nuxalk, and Wuikinuxv Nations are stewarding their marine territories.

*Meet Coyote, an Aboriginal "Legend."* Aboriginal Tourism BC, 2015. 2:34. Youtube link at

[https://youtu.be/aRe1ePS\\_hwg](https://youtu.be/aRe1ePS_hwg)

Coyote the Trickster in Interior BC First Nations cultures. Includes Coyote Markers, balancing rock monuments that mark territorial boundaries.

*Meet a Local Legend: K'umugwe Dancers.* Aboriginal Tourism BC, 2015. 3:50. Youtube link at

<http://bit.ly/2cjDsGt>

A 13 year old dancers shows his connection with his culture and the land, and performs a traditional dance in a bear costume. "I'm wearing a mask that is from a tree that is from hundreds of years ago. The fire is our connection with our ancestors."

*Meet a Local Legend: The Salmon.* Aboriginal Tourism BC. Link at

[https://youtu.be/aRe1ePS\\_hwg](https://youtu.be/aRe1ePS_hwg)

Elder Ralph Phillips of the Xat'sull First Nation talks about how the fish has sustained First Nations communities since time immemorial.

*Millions of Salmon Return Home.* National Geographic, 2014. 4:14 min.

[https://youtu.be/ZR4\\_LhPCgbo](https://youtu.be/ZR4_LhPCgbo).

This film shows the Adams River (Secwepemc Territories) salmon run, focussing on the four year cycle of the sockeye salmon cycle. It discusses the impact of climate change, particularly the rise in water temperatures.

*Mysteries of Ancient Clam Gardens.* Andrew Elizaga, 2013. 6:43 min.

[https://youtu.be/DIGn4yd15\\_I](https://youtu.be/DIGn4yd15_I)

Tom Seweid, Watchman for the Mamalilikulla Qwe'Qwa'Sor'Em territory, explains the significance of the ancient clam gardens (lo'hewae). He emphasizes that features like clam gardens and culturally modified trees are considered archeological evidence, but are also First Nations "deeds and title" to the land.

## BIBLIOGRAPHY

*The Northern Abalone in Haida Gwaii.* Haida Gwaii Stewardship Group. 7.20 min.  
<http://bit.ly/2deckcQ>

This video gives a good introduction to the abalone and the issues surrounding it, and one First Nations' approach to restoration of abalone populations. It includes excellent underwater video of the abalone.

*Rare Woolly Dog Hair Found in Coast Salish Blanket.* Burke Museum, 2017. 1.23 min.  
<https://youtu.be/W-7xcnyaZmU>.

This short video shows a blanket in a museum which has been demonstrated to show it has hair of the Coast Salish Woolly Dog.

*The Sacred Relationship.* (short) Native Counselling Services of Alberta. NCSA Video Channel, 2013. 8:00 min. <https://youtu.be/tyuVWksDJmA>.

In this short film, based on the full length documentary of the same name, Cree Elders from Alberta discuss the importance of peoples' relationships with the land and specifically with water.

*The Sacred Relationship.* (full length documentary) Native Counselling Services of Alberta. NCSA Video Channel, 2013. 52:31 min. <https://youtu.be/5NxBzyZ-8a4>

Water - The Sacred Relationship was an Alberta project that brought Cree Elders and Indigenous and Western scientists. The resulting documentary explores topics including: Indigenous Worldview; Water and Ceremony; Settlement and Colonization; Reconciliation and the common ground between Indigenous and Western Science.

*Sharing the Stories of Our Ancestors.* Indigenous Tourism BC. 2012. 1.33 min.  
<https://youtu.be/Z4UIy49qQ6U>.

This short video summarizes the importance of stories to diverse First Peoples in BC.

*Skeena River Trapline.* National Film Board, 1949, 16 min. <https://tinyurl.com/fnesc35>

This NFB documentary was made in 1949, when trapping was more of a way of life than it is today. It follows a Gitksan trapper on his trapline in the upper Skeena River region. It captures very well the trapping experience of the time, with no apparent paternalistic or racial bias, and only a slight romanticism. The term Indian is used throughout to refer to Indigenous people, and the narrator mispronounces the name Gitksan. Note: The film shows some brief scenes of shooting, skinning and butchering a deer.

*St'at'imc Grizzly.* St'at'imc Government, 2016. 5:23 min. [https://youtu.be/dDHHMDy\\_Tcw](https://youtu.be/dDHHMDy_Tcw)

Discusses the important connections the St'at'imc and other First Nations have with the grizzly bear, as a relative, symbolic of interconnections with nature. It describes the Grizzly Bear recovery project, and how the data collected are used to help manage ecosystems in their territories. See also *The Guardians of the Land*, St'at'imc Government, 2017.

## BIBLIOGRAPHY

*St'at'imc The Salmon People*. St'at'imc Government, 2016. 15:45 min.

<https://youtu.be/KMtdVqHDrwc>.

Part 1: Salmon is Life. The importance of salmon for the St'at'imc people as the major food source throughout the year. Illustrates families participating in the process of fishing and process the fish on the Fraser River, passing on their traditional knowledge. It illustrate two methods of catching fish.

Part 2: (starts at 4:02 min) Impacts to Salmon. Illustrates the impacts of dams on the Bridge River, a tributary of the Fraser River in St'at'imc territory. Discusses how industry impacts pollution of the Fraser River, and the resulting effects on the ecosystems and the salmon.

Part 3: The St'at'imc Hydro Agreement. (starts at 10:41 min.) Describes the BC Hydro-St'at'imc Authority Agreement, which means the St'at'imc have capacity to impact how BC Hydro works in their territories. Using science, the St'at'imc are able to have BC Hydro adapt some of their operations to benefit the salmon and other resource.

*The Story of Cedar* (Sechelt Arts Fest 2015). 26 min. Blue Zula, 2015.

<https://youtu.be/WlCT9Jx0T7g>.

Diverse First Nations knowledge-keepers discuss why cedar is so important to First Nations, and the important qualities of cedar for a variety of uses.

*A Subsistence Culture Impacted by Climate Change*. Arctic Athabaskan Council. 3 min.

<http://bit.ly/2cSLeGB>

This short video demonstrates the various impacts of climate change on food security of First Peoples' communities in Yukon and Alaska, particularly salmon and the muskeg ecosystem

*Two-eyed Seeing*, Cheryl Bartlett. Cape Breton University, 2012. 8:44 min.

[https://youtu.be/\\_CY-iGduw5c](https://youtu.be/_CY-iGduw5c).

First Nations people and academics discuss the important of two-eyed seeing and integrating Indigenous and Western science in schools.

*Two Sciences*. Native Counselling Services of Alberta. 7:51 min. NCSA Video Channel,

2015. <https://youtu.be/hDMcLi9IIqY>

A Cree Knowledgekeeper and a Western ecologist discuss the similarities between Indigenous and Western science, particularly as it relates to wetlands.

*A Wall Worth Building*. 3:55 min. Hakai Magazine, 2017. <https://youtu.be/22Nytmxw2Z8>.

Using scenic photography in the Gulf Islands and animation, this video explains the Traditional Ecological Knowledge behind the construction of clam gardens.

## BIBLIOGRAPHY

### 7. Interactive Websites

These websites include web-based multimedia activities and online databases.

*Against the Current: Interconnected Lives of Salmon and People on the Skeena River.* Katelyn Monk-McKenzie. Living Landscapes, Royal BC Museum, 2005. <https://tinyurl.com/fnesc40>.

This oral history project has interviews with four people engaged in the salmon fishery, including two First Nations people.

CBC. “Life on the Line. Are fur trappers stuck in the past or a vital piece of Canada’s living heritage?” CBC website and videos. <http://www.cbc.ca/news2/interactives/fur-trapping/>

This multimedia site examines two sides of the issue of trapping in contemporary Canada. It includes a 360 video taken underwater in a beaver pond, as well as text, images, maps and other graphics.

The Clam Garden Network. <https://clamgarden.com>.

This site shares up-to-date information about the study of clam gardens shared by its network of members, who included First Nations, academics, researchers and resource managers.

*Connecting Traditions.* Secwepemc Nation. <http://secwepemc.sd73.bc.ca/>

This interactive multimedia presentation gives cultural information about the Secwepemc people.

E-Flora BC Electronic Atlas of the Flora of British Columbia. <https://tinyurl.com/fnesc67>.

E-Flora BC is a biogeographic database of the vascular plants, bryophytes, lichens, algae, fungi and slime molds of British Columbia. It does not include Indigenous uses of plants.

*First Voices.* <http://www.firstvoices.com>

Web-based tools and services designed to support Aboriginal people engaged in language archiving, language teaching & culture revitalization. It has online dictionaries with pronunciations for many BC First Nations languages.

*A Journey Into Time Immemorial.* Simon Fraser Museum of Archaeology and Ethnology, 2008. [www.sfu.museum/time/](http://www.sfu.museum/time/)

An interactive multimedia website based on the story of Xá:ytem Longhouse in Mission BC. Covers many aspects of Sto:lo culture including technology. For an accessible index to tool technology, go to [www.sfu.museum/time/en/sitemap/](http://www.sfu.museum/time/en/sitemap/)

## BIBLIOGRAPHY

Kuhnlein, Harriet V and Murray M. Humphries. *Traditional Animal Foods of Indigenous Peoples of Northern North America*. McGill University. Online at <http://traditionalanimalfoods.org/>

This is a comprehensive database compiled from an academic survey of published literature about Indigenous uses of animals.

*Native Peoples, Plants & Animals: Halkomelem*. A Halkomelem Ethnobiology Web Site. Simon Fraser University. <https://www.sfu.ca/halk-ethnobiology>.

A database of biological and cultural information about plants and animals important to the Halkomelem speaking First Nations. Includes vocabulary in different dialects of Halkomelem (Island, Downriver, Upriver).

## 6. Everything Else

These are resources that have First Nations cultural and scientific content that can be used for teacher and student research. Some are available as hard copies but many are available online. Some older books may be available at a community library or through inter-library loan.

Amaron, Beryl. "More Than Useable Tools: Towards an Appreciation of Nl̓eʔkepmx Fibre Technology as a Significant Expression of Culture." UNBC Masters Thesis, 2000. Linked at <https://bit.ly/2ZiD8Px>

This thesis examines the use of fibre technologies of Nl̓eʔkepmx women to produce useful objects and at the same time to create works of art and expressions of Nl̓eʔkepmx culture.

Bannister, Kelly Patricia. "Chemistry Rooted in Cultural Knowledge: Unearthing the Links Between Antimicrobial Properties and Traditional Knowledge In Food and Medicinal Plant Resources of the Secwepemc (Shuswap) Aboriginal Nation." Doctoral Thesis, UBC, July 2000. Online at <http://bit.ly/2dyksEs>.)

Doctoral thesis merging Traditional Knowledge and Western science to study plants used by the Secwepemc First Nations.

Barsh, Russel. *The Coast Salish Woolly Dogs* Historylink.org, 2016. <https://tinyurl.com/fnesc11>

This article pulls together the history of the use of the Coast Salish woolly dog for producing hairs for spinning and weaving using archival and historical sources, which are given.



## BIBLIOGRAPHY

Big Game Information. BC Ministry of Forests, Lands and Natural Resource Operations. Online at <https://bit.ly/2DVnmRp>

This page has links to documents about the major big game animals in BC. They describe the ecology of the animal, including its ecological relationships, and its distribution and life history. The animals listed are: bighorn sheep, black bear, caribou, cougar, elk, grizzly bear, moose, mountain goat, mule and black-tailed deer, North American bison, thinhorn sheep and white-tailed deer. The documents include some information about traditional uses by First Peoples.

Bonneau, Nancy. Shuswap and Okanagan First Nation Root Food Protocols. Masters Thesis, Simon Fraser University, 2003. Available online at <http://ow.ly/m0If302O93Y>

A study of the harvesting and protocols of two important plants, bitterroot and springbeauty. Contains excerpts of interviews with people who still harvest these plants today.

Brown, F. and Y. K. Brown (compilers). *Staying the Course, Staying Alive – Coastal First Nations Fundamental Truths: Biodiversity, Stewardship and Sustainability*. Biodiversity BC, 2009. Download at [www.biodiversitybc.org](http://www.biodiversitybc.org) or link directly at <http://ow.ly/LV5X302mlHN>

Through examples from Heiltsuk, Namgis and Haida First Nations, this book discusses seven Fundamental Truths shared by most BC First Nations: Creation; Connection to Nature; Respect; Knowledge; Stewardship; Sharing; and Adapting to Change. Includes many examples from traditional stories and teachings.

Burton, Carla M. and Philip J. Burton. Recovery of *Oplopanax horridus* (Sm.) Miq., an Important Ethnobotanical Resource, after Clearcut Logging in Northwestern British Columbia. *Ethnobotany Research and Applications*, Vol. 14, 2015. <https://bit.ly/2tNiw48>

In this ethnobotanical study scientists investigated how well devil's club recovered in an area that had been clearcut.

Claxton, Earl and John Elliot Sr. *Reef Net Technology of the Saltwater People*. Saanich Indian School Board, 1994.

History and cultural use of the reef net technology. Topics include origins, technology, ceremonies, and moons and tides.

*Coast Salish Wool Dog Poster*. UBC Biology. <https://tinyurl.com/fnesc13>

This 2 page includes two large panel: Coast Salish Spinning and Weaving, and Evidence for the Coast Salish Wool Do.

Coull, Cheryl. *A Traveller's Guide to Aboriginal BC*. Whitecap Books, 1996.

An overview of all First Nations communities in BC, with local information, including tribal and community names, and significant cultural features.



## BIBLIOGRAPHY

Deur, Douglas and Nancy Turner, eds. *Keeping It Living: Traditions of Plant Use and Cultivation on Northwest Coast of North America*. University of Washington Press, 2006.

A collection of academic articles by leading researchers that document diverse Indigenous technologies for caring for over 300 species of plants.

First Nations Health Authority. *Traditional Food Facts Sheets*. <https://bit.ly/2x5bCKc>.

This is an illustrated brochure that highlights most of the major traditional foods used by First Nations in different regions of B.C. It give nutritional information for many of the foods. It also includes recipes.

Furniss, Elizabeth. *Dakelh Keyoh: The Southern Carrier in Earlier Times*. Quesnel School District and Kluskus, Nazko, Red Bluff and Ulkatcho Indian Bands, 1993.

This student book details the traditional cultures of the Southern Dakelh or Carrier First Nations. It includes information about traditional governance systems and hunting practices.

Gade, Gene. The Ancient and Arduous Art of Brain Tanning Buffalo Hides. Online article at <https://bit.ly/2SgEYfA>.

This is a US based article which focusses on tanning bison, but is applicable to other animals. It includes an explanation of the chemistry of using brains for tanning.

Gamble, Jessa. "How British Columbia's Coastal People Fertilized the Forest." Hakaimagazine.com, linked at <https://tinyurl.com/fnesc24>.

This article describes research that shows that shell middens created over millennia by First Nations caused forests to grow taller, thicker and greener.

Groesbeck AS, Rowell K, Lepofsky D, Salomon AK. "Ancient Clam Gardens Increased Shellfish Production: Adaptive Strategies from the Past Can Inform Food Security Today." *PLoS ONE* 9(3). 2014. Online link at <http://ow.ly/NJ1L303qvDU>.

A scientific article describing a study of clam gardens on BC coast that can be downloaded.

*Hunting & Trapping Regulations Synopsis*. British Columbia Fish and Wildlife Branch. <https://bit.ly/2MHPPxZ>

This guide is prepared by the BC government to inform hunters of hunting regulations and also general hunting information. It gives detailed descriptions of regional hunting areas, and gives information about regulations relating to specific species.

Indigenous Corporate Training Inc. "Indigenous Fire Management and Traditional Knowledge." 2019. <https://bit.ly/2UTXhgU>.

Describes the principal reasons that Indigenous people use controlled burning.

## BIBLIOGRAPHY

Johnson, Leslie Main. "Aboriginal Burning for Vegetation Management in Northwest British Columbia." In *Indians, Fire and the Land in the Pacific Northwest*. Robert Boyd, ed. Oregon State University Press, 1999. Linked at <https://tinyurl.com/fnesc27>.

This study explores the use of landscape burning by the Gitksan and We'suwe'ten people of the upper Skeena River region.

Joseph, Leigh. "Finding Our Roots: Ethnoecological Restoration of lhásem (*Fritillaria camschatcensis* (L.) Ker-Gawl), an Iconic Plant Food in the Squamish River Estuary, British Columbia." Masters thesis, UVic, 2012. <https://bit.ly/2TL9z9V>.

Squamish ethnobotanist Leigh Joseph investigates the traditional knowledge of the Squamish people about riceroot, and their endeavours to restore its use as a traditional food.

Kennedy, Dorothy and Randy Bouchard. *Sliammon Life, Sliammon Lands*. Vancouver: Talonbooks, 1983.

The cultures of the Homalco, Klahoose, Sliammon and Island Comox peoples. It includes information about harvesting practices, such as fishing, gathering shellfish, sea and land mammal hunting, bird hunting and plant foods. Also includes some traditional narratives.

Kirk, Ruth. *Wisdom of the Elders. Native Traditions on the Northwest Coast*. Douglas & McIntyre 1986.

This book is about the cultures of the Nuu-chah-nulth, Kwakwaka'wakw and Nuxalk peoples. Some of the relevant content includes: Houses, pp. 105-108; Tools pp. 112-113; Canoes, pp. 115-118.

Lantz, Trevor C., Kristina Swerhun, Nancy J. Turner. "Devil's Club (*Oplopanax horridus*): An Ethnobotanical Review." 2004; 62:33-48 American Botanical Council. Online at <https://bit.ly/2ToUgUh>.

A broad survey of Indigenous uses of devil's club in BC and beyond.

Lindo, John, et al. "A Time Transect of Exomes From a Native American Population Before and After European Contact." *Nature Communications*, 2016. <https://tinyurl.com/fnesc56>.

This genetic study examines the possibility of genetic links and the massive depopulation Indigenous people in North America after contact. Member of the Ts'msyen Nation participated by sharing their DNA samples.

McAllister, Ian and Nicholas Read. *The Great Bear Sea*. Orca Books, 2013.

This lavishly illustrated book shows the marine ecosystems of BC North and Central coasts. It also explores issues facing the region, including climate change, overfishing, pipelines and oil tankers.

## BIBLIOGRAPHY

McIlwraith, Thomas. *'We Are Still Didene': Stories of Hunting and History From Northern British Columbia*. University of Toronto Press, 2012.

This academic ethnographic study delves into the deep cultural relevance of hunting to the Didene, the First Nations living in northwestern BC around Iskut. The author records how the people have maintained their hunting culture through oral traditions, and explores interactions with the presence of industry in their territories.

*Management Guidelines for Furbearers*. BC Ministry of Forests, Lands and Natural Resource Operations. Online at <https://bit.ly/2GRLjfx>.

This page has links to documents about some of the key furbearing animals in BC. They describe the physical, biological, behavioural characteristics and guidelines to manage the species. The animals listed are: beaver, bobcat, coyote, fisher, fox, lynx, marten, mink, muskrat, otter, weasel, wolf, wolverine. The documents do not include information about First Peoples traditional uses of the animals.

Marshall, Amanda L. *Culturally Modified Trees of the Nechako Plateau: Cambium Utilization Amongst Traditional Carrier (Dakelh) Peoples*. M.Sc. Thesis, Simon Fraser University. 2002. Link at <https://tinyurl.com/fnesc92>.

This study combines oral histories with archaeological data of CMTs in the Dakelh traditional territories. Includes ten transcripts of Dakelh elders discussing traditional uses of inner bark as a food resource. They also encompass other aspects of TEK. Chapters on the study of CMTs may also be useful.

Menzies, Charles R. and Caroline F. Butler. "Returning to Selective Fishing through Indigenous Fisheries Knowledge." *The American Indian Quarterly* v 31, n 3. pp 441-464. 2007. Download at <http://ow.ly/pdQB302lWrU>.

This academic article suggests ways that sustainable traditional fishing techniques can be used today.

Moran, Bridget and Mary John. *Stoney Creek Woman*. Arsenal Pulp Press, 1988.

This is the story of Mary John, a Dakelh woman who was a strong leader in her community and provincially. Pages 38 to 42 describe her memories of going to hunting and trapping camps on her families traditional territories as a child. The passage explains how the whole family was involved in the hunting and trapping activities, and conveys the strong emotional attachment to those experiences.

Mortillaro, Nicole. "How Science and First Nations Oral Tradition are Converging." CBC News, 2016. <https://bit.ly/2QvEbbE>

This short article gives examples of how First Nations narratives and Western science converge, and also discusses the importance of it being a collaborative sharing of knowledge. The examples of scientific studies that support oral traditions are: the DNA study that linked the Tsimshian people of Metlakatla today with people living at Metlakatla thousands of years ago; the Inuit were not the first people to settle in the Arctic; the 1700 Cascadia earthquake.

## BIBLIOGRAPHY

Myhal, Brittany. *Food Security Concerns and Challenges of First Nations Communities in the Interior of BC*. Master of Land and Water Systems, Final Report. UBC, 2018.

<https://bit.ly/2IlkX8a>.

This is a report on case studies of two interior First Nations groups, the Esh-kn-am Cultural Resources Management Services (a joint venture of three Nlaka'pamux First Nation Bands: Coldwater, Cook's Ferry and Siska) and the Lytton First Nation.

*Nak'azdli Elders Speak: Nak'azdli t'enne Yahulduk*. Penticton: Theytus Books, 2001.

These reminiscences of seven elders from the Dakelh community of Nak'adli include traditional stories, history, cultural practices and Traditional Ecological Knowledge.

Nisga'a Nation. *From Time Before Memory*. SD 92 (Nisga'a), 1996.

A hard-cover student book that details the many aspects of traditional and modern Nisga'a culture, including social organization, roles of chiefs, feasts, Nisga'a communities, clothing, combat, Nisga'a spirituality.

Olsen, Sylvia. *Working With Wool*. Sono Nis, 2010.

A comprehensive study of Coast Salish weavers and Cowichan sweaters including traditional weaving techniques and contemporary weavers. Pages 53 to 55 detail the use of the Salish woolly dogs, bred for their hair which was important for weaving in the past.

Peacock, Sandra L. "From Complex to Simple: Balsamroot, Inulin, and the Chemistry of Traditional Interior Salish Pit-Cooking Technology." *Botany* v. 86, pp 116-208. 2008. Online at <https://bit.ly/2WtySyP>.

A scientific paper that reports on an experiment replicating traditional Interior Salish pit cooking methods. It demonstrated that pit cooking converts indigestible inulin in balsamroot into simple sugars.

Richter, Matthew and Darby Dettloff. "Experiments In Hide Brain-Tanning With A Comparative Analysis of Stone and Bone Tools." <https://bit.ly/2DX9VAj>.

A US scientific study investigating traditional methods of brain tanning.

*River of Salmon Peoples*. Theytus Books, 2015.

Memories, stories and voices of First Peoples living in the Fraser River watershed, including Musqueam; Lil'wat7ul Mount Currie; Secwepemc; Nle'kepmxcinm; Dakelh and Tsilhqot'in; Sardis, Stó:Lō, and Seabird Island Stó:Lō communities. Includes text and photographs organized in five chapters: 1. The Fraser River as a Unifying Form; 2. The Fraser River as an Expression of Diversity; 3. The Fraser River as History of Change; 4. The Fraser River as a Spiritual and Cultural Relationship; 5. The Fraser River as a Place of Hope and Reconciliation.

## BIBLIOGRAPHY

Simmons, Ellen. "British Columbia's Indigenous People: The Burning Issue." *Journal of Ecosystems & Management* 13 (2), 2012. <https://bit.ly/2L1aBLT>.

This article gives an overview of controlled burning, with a focus on Syilx First Nations in the Okanagan.

Stewart, Hilary. *Indian Fishing*. Douglas & McIntyre, 1977. Reprinted 2018, Quadra Recreation Society.

Detailed study of fishing technologies of BC coastal First Nations. In text and many illustrations, describes fishing methods, fishing tools and cooking and processing methods. Also includes discussion of spiritual realms.

Stewart, Hilary. *Stone, Bone, Antler and Shell. Artifacts of the Northwest Coast*. Douglas & McIntyre, 1996.

Detailed study of the many ways that stone, bone and other materials were and are used by BC First Nations. Includes many diagrams and illustrations.

Stewart, Hilary. *Cedar: Tree of Life to the Northwest Coast Indians*. Vancouver, B.C.: Douglas & McIntyre, 1984.

Detailed study of the many ways that cedar is used by BC First Nations. Includes many diagrams and illustrations.

*Taking Nature's Pulse: The Status of Biodiversity in British Columbia*. Biodiversity BC, 2008. Available at the Biodiversity BC website, [www.biodiversitybc.org](http://www.biodiversitybc.org). <https://bit.ly/2KmybAI>

This 268-page report addresses land and freshwater biodiversity, and pressures on biodiversity caused by human activity, including climate change. It includes useful discussions of what biodiversity is, using BC examples. The document is available to download, or can be view in HTML format.

Tepper, Leslie H. *Earth Line and Morning Star. Nlaka'pamux Clothing Traditions*. Canadian Museum of Civilization, 1994.

A comprehensive study of the traditional and post-contact clothing technologies of the Nlaka'pamux First Nation, including woven and skin clothing. Pages 49-55 deal with tanning processes. Traditional dyes are also covered.

Trant, Andrew J. *et al.* "Intertidal Resource Use Over Millennia Enhances Forest Productivity. *Nature Communications* 7, 2016. Linked at <https://tinyurl.com/fnesc25>.

This scientific study shows that soils at First Nations habitat sites on the BC coast are higher in calcium and phosphorous, resulting in taller Western red cedar growth.

Trigg, Nicole. "Getting Back to Her Roots. *The Squamish Chief*. June 24, 2011. <https://bit.ly/2UACM4w>.

This article explains how ethnobotanist Leigh Joseph studied the rice root plant for her Master's thesis, and involved the Squamish community to restore the estuary gardening of rice root.

## BIBLIOGRAPHY

Ts'elxwéyeqw Tribe. *Being Ts'elxwéyeqw: First Peoples' Voices and History from the Chilliwack-Fraser Valley, British Columbia*. David M. Schaepe, Ed. Harbour Publishing, 2017.

This large and comprehensive book is richly illustrated with pictures and maps that detail the territories of the Ts'elxwéyeqw (Chilliwack) people. The text is largely composed of interviews with people of the Ts'elxwéyeqw Nation, accompanied by contextual material. It includes examples of the histories and stewardship of specific territories throughout the book. As well, the chapter Hunting, Fishing, Gathering and Relations with the Environment will be useful for Unit 9, Hunting and Trapping.

Turner, Nancy J. *Ancient Pathways, Ancestral Knowledge*. Volumes 1 and 2. McGill-Queen's University Press, 2014.

An extensive study of how knowledge of plants and environments has been applied and shared over centuries and millennia by Indigenous peoples of BC. Both volumes include many tables that present a great depth of information in an accessible graphic format for students.

Turner, Nancy J. *The Earth's Blanket, Traditional Teachings for Sustainable Living*. Douglas & McIntyre, 2005.

Nancy Turner suggests insightful critiques of western concepts of environmental management and scientific ecology and proposes how systems of Traditional Ecological Knowledge can be recognized and enhanced.

Turner, Nancy J. "Importance of Biodiversity for First Peoples of British Columbia." Biodiversity BC, 2007. Available at the Biodiversity BC website, [www.biodiversitybc.org](http://www.biodiversitybc.org). Direct link at <https://tinyurl.com/fnesc82>.

A report written for the Status of Biodiversity in BC, 2007.

Turner, Nancy J. "Traditional use of devil's club (*Oplonanax horridus*: Araliaceae) by Native Peoples in Western North America." *Journal of Ethnobiology* 1982;2:1-11. <https://tinyurl.com/fnesc66>

An ethnobotanical report on devil's club.

Turner, Nancy J. and Helen Clifton. "'It's so different today': Climate change and Indigenous Lifeways in British Columbia." *Canada Global Environmental Change* 19, (2009) 180-190. Linked at <http://bit.ly/2dj8hvY>

This article on Indigenous perspectives on climate change discusses environmental change and challenges to the resilience of Traditional Knowledge, including topics such as species declines and new appearances; anomalies in weather patterns; and declining health of forests and grasslands.

## BIBLIOGRAPHY

Turner, Nancy J., Marianne Boelscher Ignace, and Ronald Ignace. "Traditional Ecological Knowledge and Wisdom of Aboriginal Peoples in British Columbia." *Ecological Applications* 10.5 (2000): 1275-287. Available online at <http://bit.ly/2cVwEOM>

This paper gives an overview of the qualities of Traditional Ecological Knowledge, with examples from the Secwepemc, Kwakwaka'wakw and Nuu-Chah-Nulth First Nations. Includes a case study of the knowledge and use of the plants avalanche lily and balsamroot.

Turner, Nancy and Fikret Berkes. Coming to Understanding: Developing Conservation through Incremental Learning in the Pacific Northwest. *Human Ecology* v. 34, 2006. Pages 495-513. Online at <https://bit.ly/2H9U9FD>.

This academic article surveys diverse Indigenous pathways to ecological understanding and conservation. It includes as an example the reef net fishery.

Turner, Nancy J., Randy Bouchard, Dorothy I.D. Kennedy. *Ethnobotany of the Okanagan-Colville Indians of British Columbia and Washington*. BC Provincial Museum, 1980.

Includes a section titled "The Role of Plants in Okanagan-Colville Culture" (pages 146-154).

Vernon, Caitlyn. *Nowhere Else on Earth: Standing Tall for the Great Bear Rainforest*. Caitlin Books, 2011.

Filled with history, biology, geography, ecology, environmental studies, personal anecdotes, pictures, and activities about the Great Bear Rainforest.

Warner, Graham and David Gidmark. *Canoe Paddles, a Complete Guide to Making Your Own*. Firefly, 2001.

A comprehensive guide to the history and construction of paddles, including many Indigenous examples.

Weatherdon, Lauren V., Yoshitaka Ota, Miranda C. Jones, David A. Close, William W. L. Cheung. "Projected Scenarios for Coastal First Nations' Fisheries Catch Potential under Climate Change: Management Challenges and Opportunities." *PLOS* January 13, 2016. Online at <https://bit.ly/2V18ub2>.

A UBC study that examines the impacts of climate change for coastal First Nations communities where marine resources are crucial for both food and economic security.

Williams, Judith. *Clam Gardens*. New Star Books, 2006.

One of the first studies to examine the management of clam beds by coastal First Nations.









FIRST NATIONS EDUCATION STEERING COMMITTEE  
& FIRST NATIONS SCHOOLS ASSOCIATION  
113-100 PARK ROYAL SOUTH, WEST VANCOUVER, BC V7T 1A2  
[FNESC.CA/LEARNINGFIRSTPEOPLES](http://FNESC.CA/LEARNINGFIRSTPEOPLES)

